

# 2SJ575

Silicon P Channel MOS FET  
High Speed Switching

# HITACHI

ADE-208-740B (Z)  
3rd.Edition.  
June 1999

## Features

- Low on-resistance  
 $R_{DS} = 2.8$  typ. ( $V_{GS} = -10$  V,  $I_D = -50$  mA)  
 $R_{DS} = 5.7$  typ. ( $V_{GS} = -4$  V,  $I_D = -50$  mA)
- 4 V gate drive device.
- Small package (MPAK)

## Outline

MPAK

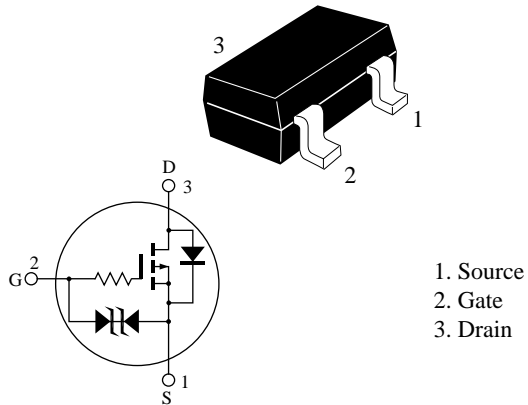

## Absolute Maximum Ratings (Ta = 25°C)

Item	Symbol	Ratings	Unit
Drain to source voltage	$V_{DSS}$	-30	V
Gate to source voltage	$V_{GSS}$	±20	V
Drain current	$I_D$	-100	mA
Drain peak current	$I_{D(pulse)}$ <sup>Note 1</sup>	-400	mA
Body-drain diode reverse drain current	$I_{DR}$	-100	mA
Channel dissipation	Pch <sup>Note 2</sup>	400	mW
Channel temperature	Tch	150	°C
Storage temperature	Tstg	-55 to +150	°C

Note: 1. PW 10 μs, duty cycle 1%

2. Value on the alumina ceramic board (12.5x20x0.7mm)

## Electrical Characteristics (Ta = 25°C)

Item	Symbol	Min	Typ	Max	Unit	Test Conditions
Drain to source breakdown voltage	$V_{(BR)DSS}$	-30	—	—	V	$I_D = -100 \mu A, V_{GS} = 0$
Gate to source breakdown voltage	$V_{(BR)GSS}$	±20	—	—	V	$I_G = \pm 100 \mu A, V_{DS} = 0$
Gate to source leak current	$I_{GSS}$	—	—	±5	μA	$V_{GS} = \pm 16 V, V_{DS} = 0$
Zero gate voltage drain current	$I_{DSS}$	—	—	-1	μA	$V_{DS} = -30 V, V_{GS} = 0$
Gate to source cutoff voltage	$V_{GS(off)}$	-1.3	—	-2.3	V	$I_D = -10 \mu A, V_{DS} = -5 V$
Static drain to source on state resistance	$R_{DS(on)}$	—	2.8	3.3		$I_D = -50 mA, V_{GS} = -10 V$ <sup>Note 3</sup>
	$R_{DS(on)}$	—	5.7	7.9		$I_D = -50 mA, V_{GS} = -4 V$ <sup>Note 3</sup>
Forward transfer admittance	$ y_{fs} $	68	105	—	mS	$I_D = -50 mA, V_{DS} = -10 V$ <sup>Note 3</sup>
Input capacitance	Ciss	—	25	—	pF	$V_{DS} = -10 V$
Output capacitance	Coss	—	20	—	pF	$V_{GS} = 0$
Reverse transfer capacitance	Crss	—	8	—	pF	f = 1 MHz
Turn-on delay time	$t_{d(on)}$	—	10	—	ns	$I_D = -50 mA, V_{GS} = -10 V$
Rise time	$t_r$	—	15	—	ns	$R_L = 200$
Turn-off delay time	$t_{d(off)}$	—	40	—	ns	
Fall time	$t_f$	—	45	—	ns	

Note: 3. Pulse test

4. Marking is AP

## Main Characteristics

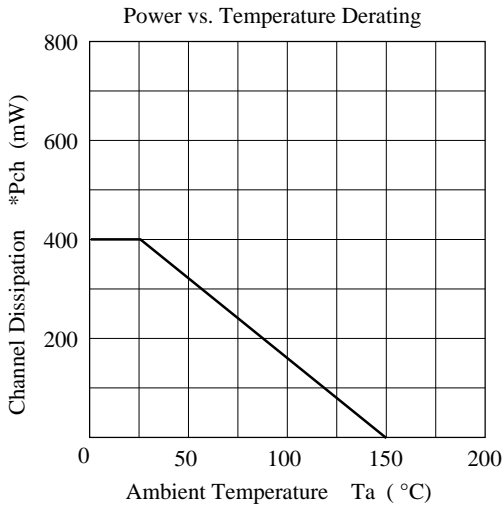

\*Value on the alumina ceramic board (12.5x20x0.7mm)

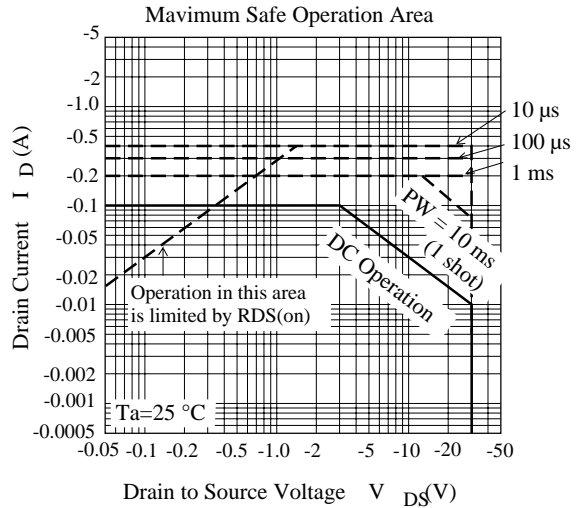

Value on the alumina ceramic board (12.5x20x0.7mm)

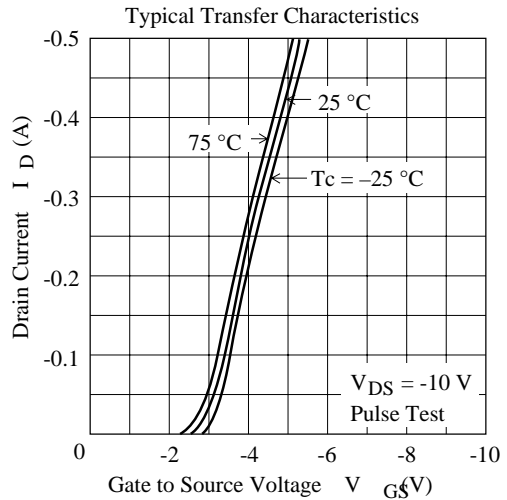
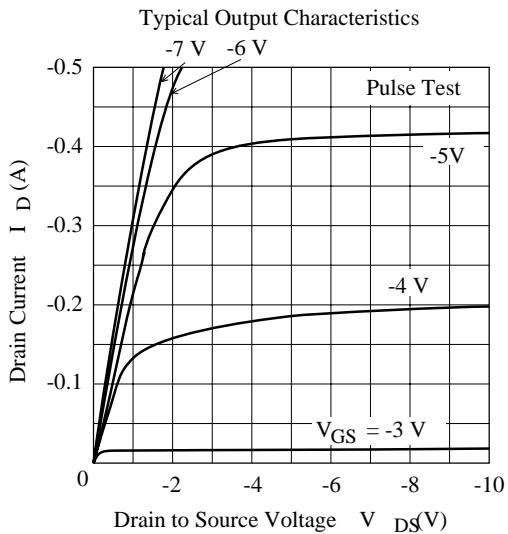

Drain to Source Saturation Voltage vs. Gate to Source Voltage

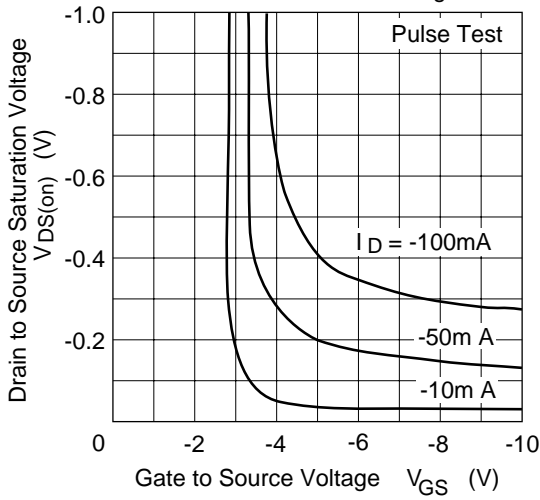

Static Drain to Source on State Resistance vs. Drain Current

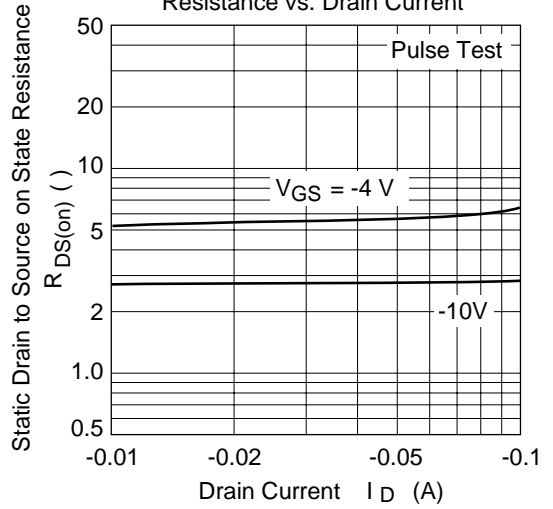

Static Drain to Source on State Resistance vs. Temperature

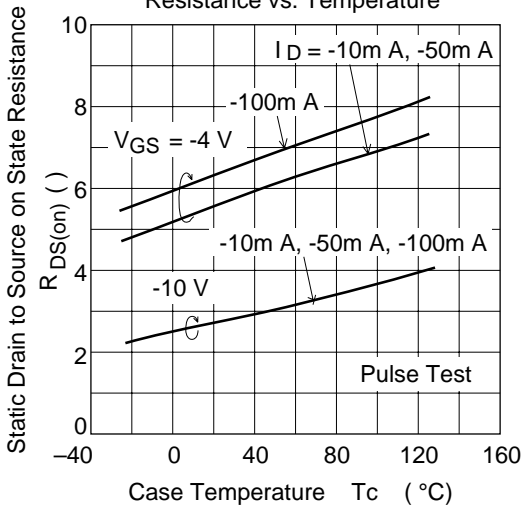

Typical Transfer Characteristics

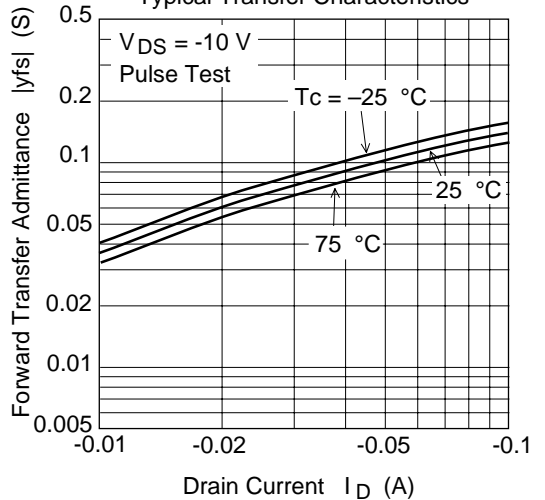

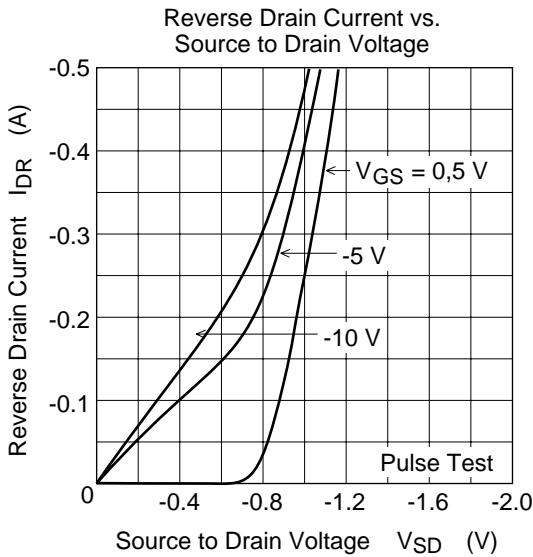
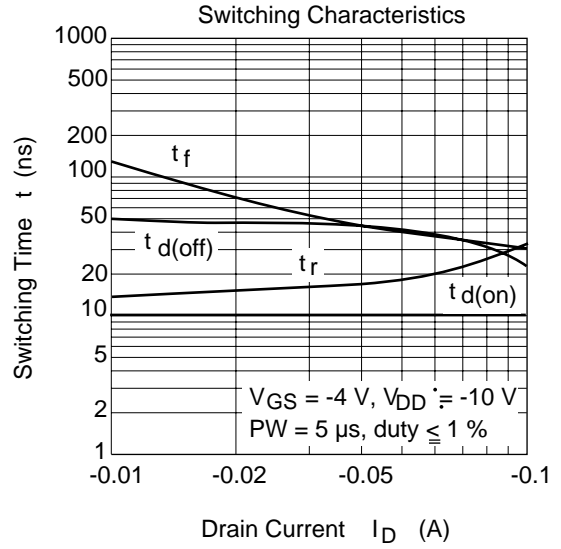
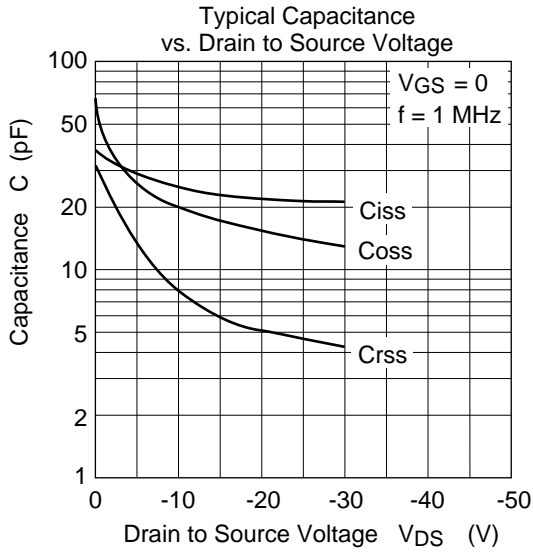

Switching Time Test Circuit

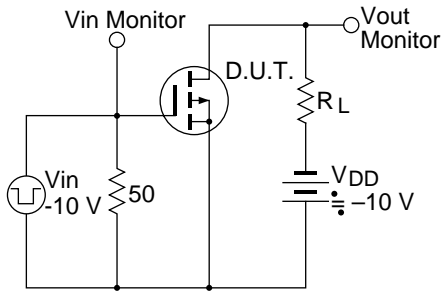

Waveforms

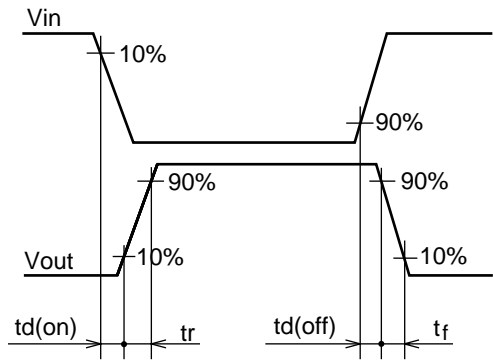

Package Dimensions

As of January, 2001  
Unit: mm

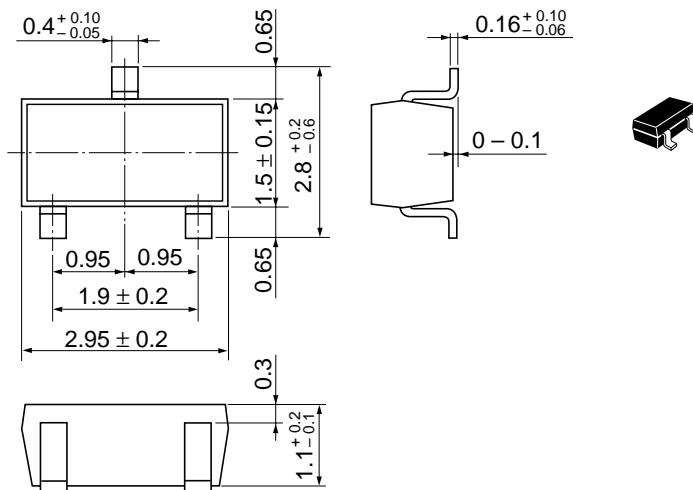

Hitachi Code	MPAK
JEDEC	—
EIAJ	Conforms
Mass (reference value)	0.011 g

**Cautions**

1. Hitachi neither warrants nor grants licenses of any rights of Hitachi's or any third party's patent, copyright, trademark, or other intellectual property rights for information contained in this document. Hitachi bears no responsibility for problems that may arise with third party's rights, including intellectual property rights, in connection with use of the information contained in this document.
2. Products and product specifications may be subject to change without notice. Confirm that you have received the latest product standards or specifications before final design, purchase or use.
3. Hitachi makes every attempt to ensure that its products are of high quality and reliability. However, contact Hitachi's sales office before using the product in an application that demands especially high quality and reliability or where its failure or malfunction may directly threaten human life or cause risk of bodily injury, such as aerospace, aeronautics, nuclear power, combustion control, transportation, traffic, safety equipment or medical equipment for life support.
4. Design your application so that the product is used within the ranges guaranteed by Hitachi particularly for maximum rating, operating supply voltage range, heat radiation characteristics, installation conditions and other characteristics. Hitachi bears no responsibility for failure or damage when used beyond the guaranteed ranges. Even within the guaranteed ranges, consider normally foreseeable failure rates or failure modes in semiconductor devices and employ systemic measures such as fail-safes, so that the equipment incorporating Hitachi product does not cause bodily injury, fire or other consequential damage due to operation of the Hitachi product.
5. This product is not designed to be radiation resistant.
6. No one is permitted to reproduce or duplicate, in any form, the whole or part of this document without written approval from Hitachi.
7. Contact Hitachi's sales office for any questions regarding this document or Hitachi semiconductor products.

# HITACHI

**Hitachi, Ltd.**

Semiconductor & Integrated Circuits.  
 Nippon Bldg., 2-6-2, Ohte-machi, Chiyoda-ku, Tokyo 100-0004, Japan  
 Tel: Tokyo (03) 3270-2111 Fax: (03) 3270-5109

URL	NorthAmerica	: <a href="http://semiconductor.hitachi.com/">http://semiconductor.hitachi.com/</a>
	Europe	: <a href="http://www.hitachi-eu.com/hel/ecg">http://www.hitachi-eu.com/hel/ecg</a>
	Asia	: <a href="http://sicapac.hitachi-asia.com">http://sicapac.hitachi-asia.com</a>
	Japan	: <a href="http://www.hitachi.co.jp/Sicd/indx.htm">http://www.hitachi.co.jp/Sicd/indx.htm</a>

**For further information write to:**

Hitachi Semiconductor  
 (America) Inc.  
 179 East Tasman Drive,  
 San Jose, CA 95134  
 Tel: <1> (408) 433-1990  
 Fax: <1> (408) 433-0223

Hitachi Europe GmbH  
 Electronic Components Group  
 Dornacher Straße 3  
 D-85622 Feldkirchen, Munich  
 Germany  
 Tel: <49> (89) 9 9180-0  
 Fax: <49> (89) 9 29 30 00

Hitachi Europe Ltd.  
 Electronic Components Group.  
 Whitebrook Park  
 Lower Cookham Road  
 Maidenhead  
 Berkshire SL6 8YA, United Kingdom  
 Tel: <44> (1628) 585000  
 Fax: <44> (1628) 585160

Hitachi Asia Ltd.  
 Hitachi Tower  
 16 Collyer Quay #20-00,  
 Singapore 049318  
 Tel : <65>-538-6533/538-8577  
 Fax : <65>-538-6933/538-3877  
 URL : <http://www.hitachi.com.sg>

Hitachi Asia Ltd.  
 (Taipei Branch Office)  
 4/F, No. 167, Tun Hwa North Road,  
 Hung-Kuo Building,  
 Taipei (105), Taiwan  
 Tel : <886>-(2)-2718-3666  
 Fax : <886>-(2)-2718-8180  
 Telex : 23222 HAS-TP  
 URL : <http://www.hitachi.com.tw>

Hitachi Asia (Hong Kong) Ltd.  
 Group III (Electronic Components)  
 7/F., North Tower,  
 World Finance Centre,  
 Harbour City, Canton Road  
 Tsim Sha Tsui, Kowloon,  
 Hong Kong  
 Tel : <852>-(2)-735-9218  
 Fax : <852>-(2)-730-0281  
 URL : <http://www.hitachi.com.hk>

Copyright © Hitachi, Ltd., 2000. All rights reserved. Printed in Japan.  
 Colophon 2.0