

EVALUATION KIT
AVAILABLE

MAXIM

Complete Audio/Video Backend Solution

MAX4079

General Description

The MAX4079 filters and buffers video (NTSC/PAL/DVB) and stereo audio signals from the MPEG decoder of a cable/satellite receiver, VCR/DVD player, or a TV to an external load. The MAX4079 has luma-chroma (Y-C) and composite (CVBS) video inputs with one Y-C and two CVBS outputs. All video inputs are AC-coupled with internal DC biasing on the chroma input and active clamps for the luma and composite.

The MAX4079 video reconstruction filters have a 6MHz cutoff frequency and 50dB attenuation at 27MHz. The filters are matched with flat group delay for standard-definition video. The video gain is fixed at +6dB to drive a 75Ω back-terminated load (150Ω) to unity gain. The video outputs can be either DC- or AC-coupled and are powered by a single +5V supply.

The MAX4079 audio amplifiers have differential inputs for optimum performance, but can be used with single-ended sources with external biasing. The audio channels have a fixed gain of +6dB and deliver 2.6VRMS output with a differential input of ±1.85V. The audio amplifiers operate from a +9V to +12V single supply and feature an internal bias generator. An on-chip mixer also provides a mono output, with +3dB gain, derived from the left and right audio channels.

The MAX4079 is available in 24-pin TSSOP package, and is fully specified over the 0°C to +70°C commercial temperature range. The MAX4079 Evaluation Kit is available to help speed designs.

Applications

Satellite Receivers
Cable Receivers
Home Theater Systems
DVD Players
AV Receivers
Televisions

Pin Configuration appears at end of data sheet.

MAXIM

Features

- ◆ Integrated Video Reconstruction Filters—6MHz Lowpass Filter Supports NTSC, PAL, or DVB per ITU-601
- ◆ Integrated Video and Audio Amplifiers
- ◆ Integrated Video Input Clamps and Biasing
- ◆ Mono Audio and CVBS Output to Drive External Modulator
- ◆ +5V (Video) and +9V to +12V (Audio) Single-Supply Operation
- ◆ Differential/Single-Ended Audio Inputs
- ◆ 24-Pin TSSOP Package

Ordering Information

PART	TEMP RANGE	PIN-PACKAGE
MAX4079CUG+	0°C to +70°C	24 TSSOP

+ Denotes lead(Pb)-free package.

Functional Diagram

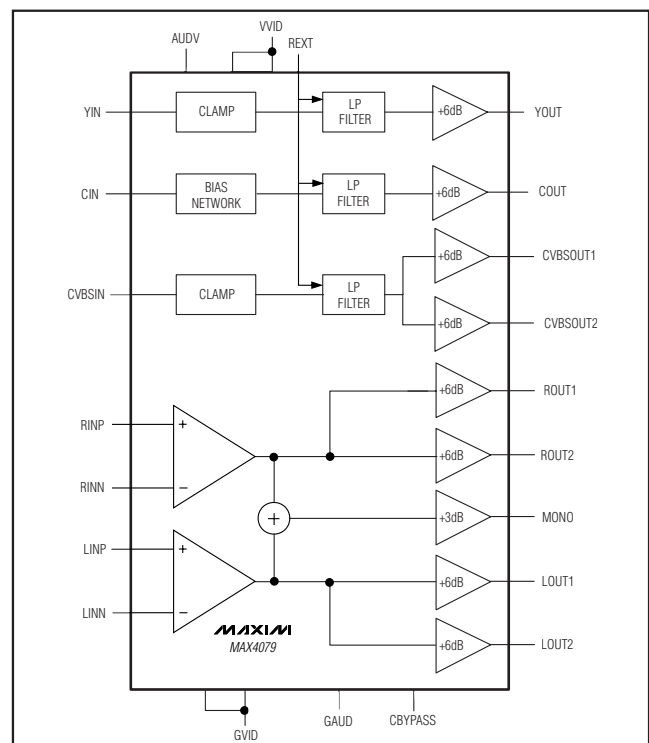

Maxim Integrated Products 1

For pricing, delivery, and ordering information, please contact Maxim Direct at 1-888-629-4642, or visit Maxim's website at www.maxim-ic.com.

Complete Audio/Video Backend Solution

ABSOLUTE MAXIMUM RATINGS

GVID to GAUD.....	-0.1V to +0.1V
VVID to GVID.....	-0.3V to +6V
AUDV to GAUD.....	-0.3V to +14V
LINP, LINN, RINP, RINN, CBYPASS to GAUD.....	-0.3V to +6V
LOUT1, LOUT2, ROUT1, ROUT2, MONO to GAUD.....	-0.3V to lower of (+9V and AUDV + 0.3V)
YIN, CIN, CVBSIN, REXT to GVID.....	-0.3V to (VVID + 0.3V)
YOUT, COUT, CVBSOUT1, CVBSOUT2 to GVID.....	-0.3V to (VVID + 0.3V)
Video Output Short-Circuit Duration to GVID or VVID.....	Continuous

Audio Output Short-Circuit Duration to GAUD or AUDV.....	Continuous
Continuous Power Dissipation (T _A = +70°C) 24-Pin TSSOP (derate 12.2mW/°C above +70°C).....	975.6mW
Operating Temperature Range.....	0°C to +70°C
Storage Temperature Range.....	-65°C to +150°C
Junction Temperature.....	+150°C
Lead Temperature (soldering, 10s).....	+300°C

Stresses beyond those listed under "Absolute Maximum Ratings" may cause permanent damage to the device. These are stress ratings only, and functional operation of the device at these or any other conditions beyond those indicated in the operational sections of the specifications is not implied. Exposure to absolute maximum rating conditions for extended periods may affect device reliability.

DC ELECTRICAL CHARACTERISTICS

(V_{VVID} = +5V, V_{AUDV} = +12V, V_{GVID} = V_{GAUD} = 0V, R_{LOAD_VID} = 150Ω to GVID, R_{REXT} = 10kΩ ±1%, C_{CBYPASS} = 1μF, T_A = 0°C to +70°C, unless otherwise noted. Typical values are at T_A = +25°C.) (Note 1)

PARAMETER	SYMBOL	CONDITIONS	MIN	TYP	MAX	UNITS
SUPPLIES						
Audio Supply Voltage Range	AUDV		8.5		12.6	V
Video Supply Voltage Range	VVID		4.75	5.0	5.25	V
Video Quiescent Supply Current	I _{CCV}	V _{VVID} = 5.25V, no load, all video inputs AC-coupled to ground		60	100	mA
Audio Quiescent Supply Current	I _{CCA}	V _{AUDV} = 12.6V, no load, audio inputs biased at 2.5V		8	15	mA
Thermal Shutdown	T _{SD}	Rising die temperature		+150		°C
Thermal-Shutdown Hysteresis	T _{SD,HYS}			25		°C
VIDEO						
Voltage Gain	A _{V,VID}	V _{IN} = 1V _{P-P} , all video inputs, no load	5.8	6	6.2	dB
Gain Matching	ΔA _{V,VID}	V _{IN} = 1V _{P-P} , all video inputs, no load	-0.4		+0.4	dB
Input Voltage Swing	V _{IN,VID}	YIN, CVBSIN	0		1.2	V _{P-P}
		CIN	0		0.9	
Clamp Voltage	V _{CLMP}	CVBSOUT_ and YOUT, no signal, no load		1.0		V
Chroma Bias	V _{BIAS}	COUT, no signal, no load		2.1		V
Droop	D	(Note 2)			2	%
REXT Reference Voltage	V _{REXT}		0.85	1.00	1.15	V
Input Resistance	R _{IN,VID}	CVBSIN or YIN		2.3		MΩ
		CIN		10		kΩ
Input Clamping Current	I _{CLMP}	CVBSIN or YIN input, V _{IN} = 3.5V	1	2.5	4	μA
Output Voltage Swing	V _{OUT,VID}	CVBSOUT_ , YOUT		2.4		V _{P-P}
		COUT		1.8		
Short-Circuit Current	I _{SC,VID}	Video output shorted to VVID or GVID		50		mA
Power-Supply Rejection Ratio	PSRR _{VID}	4.75V ≤ V _{VVID} ≤ 5.25V	YOUT/COUT		48	dB
			CVBSOUT_		48	

Complete Audio/Video Backend Solution

MAX4079

DC ELECTRICAL CHARACTERISTICS (continued)

($V_{VID} = +5V$, $V_{AUDV} = +12V$, $V_{GVID} = V_{GAUD} = 0V$, $R_{LOAD_VID} = 150\Omega$ to G_{VID} , $R_{REXT} = 10k\Omega \pm 1\%$, $C_{CBYPASS} = 1\mu F$, $T_A = 0^\circ C$ to $+70^\circ C$, unless otherwise noted. Typical values are at $T_A = +25^\circ C$.) (Note 1)

PARAMETER	SYMBOL	CONDITIONS	MIN	TYP	MAX	UNITS
AUDIO						
Voltage Gain	$A_{V,AUD}$	1.414V _{P-P} differential input	5.8	6	6.2	dB
Mono Voltage Gain	$A_{V,MONO}$	1.414V _{P-P} differential input, $L_{IN} = R_{IN}$	2.8	3	3.2	dB
Gain Matching Between Channels	$\Delta A_{V,AUD}$	1.414V _{P-P} differential input	-0.4		+0.4	dB
Input Voltage Range	$V_{IN,AUD}$	Inferred from CMRR test	0.3		5.2	V
Differential Input Voltage Range	$V_{IN,AUD\ DIF}$	Inferred from output voltage swing	-1.85		+1.85	V
Input Current	$I_{IN,AUD}$				2	μA
Output Voltage Swing	$V_{OUT,AUD}$	Input overdriven, 10k Ω load to 4.15V	7.4			V _{P-P}
Short-Circuit Current	$I_{SC,AUD}$			15		mA
Power-Supply Rejection Ratio	$PSRR_{AUD}$	$8.5V \leq V_{AUDV} \leq 12.6V$	70			dB
Common-Mode Rejection Ratio	$CMRR_{AUD}$	$0.3V \leq V_{CM} \leq 5.2V$	50	60		dB

AC ELECTRICAL CHARACTERISTICS

($V_{VID} = +5V$, $V_{AUDV} = +12V$, $V_{GVID} = V_{GAUD} = 0V$, $R_{IN_VIDEO} = 75\Omega$ to G_{VID} , $C_{IN_VIDEO} = 0.1\mu F$, $R_{LOAD_VID} = 150\Omega$ to G_{VID} , $C_{OUT_AUDIO} = 10\mu F$, $R_{LOAD_AUD} = 10k\Omega \pm 1\%$ to G_{AUD} , $R_{REXT} = 10k\Omega$, $C_{CBYPASS} = 1\mu F$, $T_A = 0^\circ C$ to $+70^\circ C$, unless otherwise noted. Typical values are at $T_A = +25^\circ C$.) (Note 1)

PARAMETER	SYMBOL	CONDITIONS	MIN	TYP	MAX	UNITS
VIDEO						
Filter Attenuation	A_{VIDEO}	CVBSOUT1 = CVBSOUT2 = YOUT = COUT = 2V _{P-P} ; $R_L = 150\Omega$ to ground, attenuation is referred to 100kHz	f = 4MHz	-0.5	+0.5	dB
			f = 7MHz		3	
			f = 27MHz	40	50	
Slew Rate	SR	$V_{OUT} = 2V_{P-P}$		30		V/ μs
Differential Gain	DG	CVBSOUT ₋ , YOUT, COUT, 5-step modulated staircase		0.5		%
Differential Phase	DP	CVBSOUT ₋ , YOUT, COUT, 5-step modulated staircase		0.9		degrees
Power-Supply Rejection Ratio	$PSRR_{VID}$	f = 100kHz, 0.5V _{P-P}	YOUT/COUT		48	dB
			CVBSOUT ₋		44	
Peak Signal to RMS Noise	SNR_{VID}	CVBSOUT ₋ , YOUT, COUT, $V_{IN} = 1V_{P-P}$		65		dB
Group Delay Deviation	GD	CVBSOUT ₋ , YOUT, COUT, $f_{IN} = 0.1MHz$ to 4.5MHz		25		ns
Output Impedance	$Z_{OUT,VID}$	f = 3.58MHz		0.5		Ω
Capacitive Load	$C_{L,VID}$	No sustained oscillations		35		pF
Video Crosstalk	$X_{TALK,VID}$	f = 3.58MHz, 1V _{P-P} input, between any two active inputs		-63		dB
Audio/Video Crosstalk	$X_{TALK,VD/AD}$	f = 15kHz, 1V _{P-P} input, between any two active audio or video inputs		-76		

Complete Audio/Video Backend Solution

AC ELECTRICAL CHARACTERISTICS (continued)

($V_{VVID} = +5V$, $V_{AUDV} = +12V$, $V_{GVID} = V_{GAUD} = 0V$, $R_{IN_VIDEO} = 75\Omega$ to G_{VID} , $C_{IN_VIDEO} = 0.1\mu F$, $R_{LOAD_VID} = 150\Omega$ to G_{VID} , $C_{OUT_AUDIO} = 10\mu F$, $R_{LOAD_AUD} = 10k\Omega \pm 1\%$ to G_{AUD} , $R_{REXT} = 10k\Omega$, $C_{CBYPASS} = 1\mu F$, $T_A = 0^\circ C$ to $+70^\circ C$, unless otherwise noted. Typical values are at $T_A = +25^\circ C$.) (Note 1)

PARAMETER	SYMBOL	CONDITIONS	MIN	TYP	MAX	UNITS
AUDIO						
Gain Flatness	ΔA_{AUD}	$L_{OUT_}$, $R_{OUT_}$, $f_{IN} = 20Hz$ to $20kHz$, $0.5V_{RMS}$ input		0.01		dB
		MONO, $f_{IN} = 20kHz$ to $20kHz$, $0.5V_{RMS}$ input		0.01		
Signal-to-Noise Ratio	SNR_{AUD}	$f_{IN} = 1.0kHz$, $0.5V_{RMS}$, CCIR weighing highpass filter at $20kHz$, lowpass filter at $20kHz$		85		dB
Total Harmonic Distortion Plus Noise	THD+N	$f_{IN} = 1.0kHz$, $0.5V_{RMS}$		0.005		%
		$f_{IN} = 1.0kHz$, $1V_{RMS}$		0.003		
Output Impedance	$Z_{O,AUD}$	$f = 1kHz$		0.2		Ω
Power-Supply Rejection Ratio	$PSRR_{AUD,AC}$	$f = 1kHz$, $V_{RIPPLE} = 200mV_{P-P}$		60		dB
Crosstalk	$X_{TLK,AUD}$	$f = 1kHz$, $0.5V_{RMS}$ input		70		dB
Capacitive Load	$C_{L,AUD}$	No sustained oscillations		200		pF

Note 1: All devices are 100% production tested at $T_A = +25^\circ C$. Specifications over temperature limits are guaranteed by design.

Note 2: Droop is defined as the percentage change in the DC level from the start to the end of a video line. Inferred from input clamping current with a $0.1\mu F$ coupling capacitor.

Typical Operating Characteristics

($V_{VVID} = +5V$, $V_{AUDV} = +12V$, $V_{GVID} = V_{GAUD} = 0V$, $R_{IN_VIDEO} = 75\Omega$ to G_{VID} , $C_{IN_VIDEO} = 0.1\mu F$, $R_{LOAD_VID} = 150\Omega$ to G_{VID} , $C_{OUT_AUDIO} = 10\mu F$, $R_{LOAD_AUD} = 10k\Omega$ to G_{AUD} , $R_{REXT} = 10k\Omega$, $C_{BYPASS} = 1\mu F$, $T_A = +25^\circ C$, unless otherwise noted.)

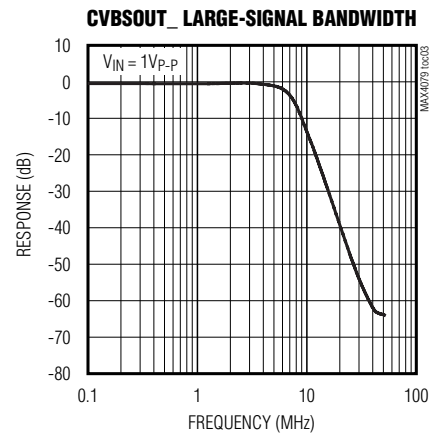
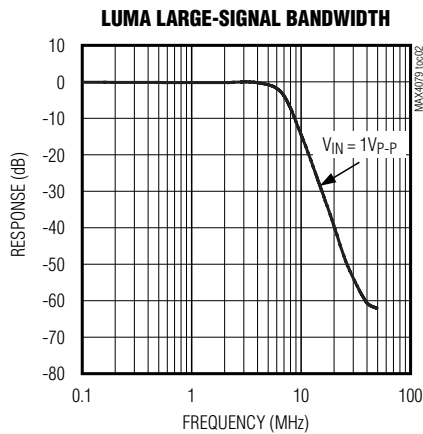
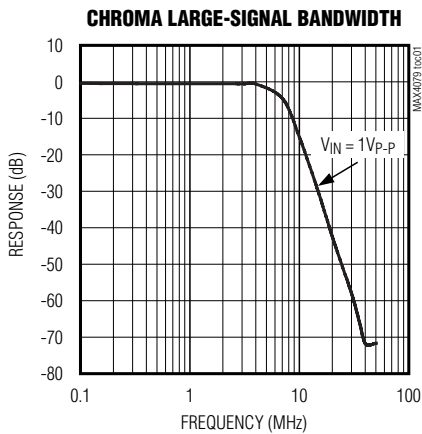

Complete Audio/Video Backend Solution

MAX4079

Typical Operating Characteristics (continued)

($V_{VID} = +5V$, $V_{AUDV} = +12V$, $V_{GVID} = V_{GAUD} = 0V$, $R_{IN_VIDEO} = 75\Omega$ to G_{VID} , $C_{IN_VIDEO} = 0.1\mu F$, $R_{LOAD_VID} = 150\Omega$ to G_{VID} , $C_{OUT_AUDIO} = 10\mu F$, $R_{LOAD_AUD} = 10k\Omega$ to G_{AUD} , $R_{REXT} = 10k\Omega$, $C_{BYPASS} = 1\mu F$, $T_A = +25^\circ C$, unless otherwise noted.)

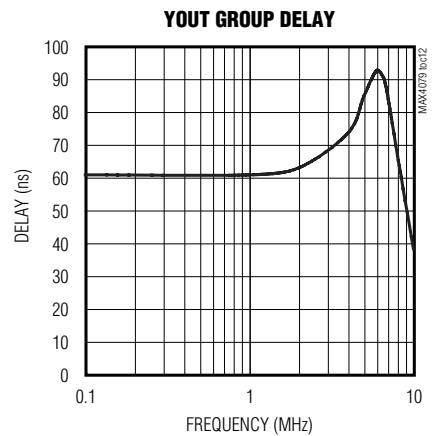
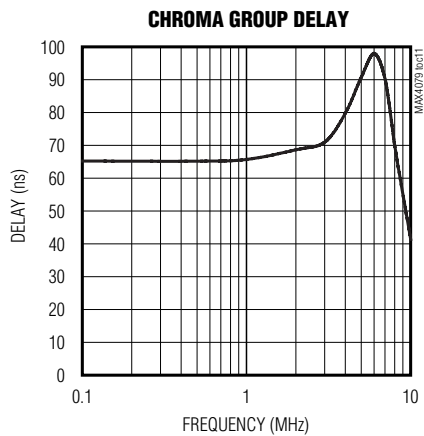
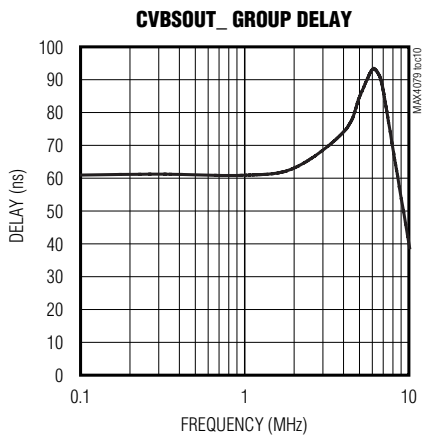
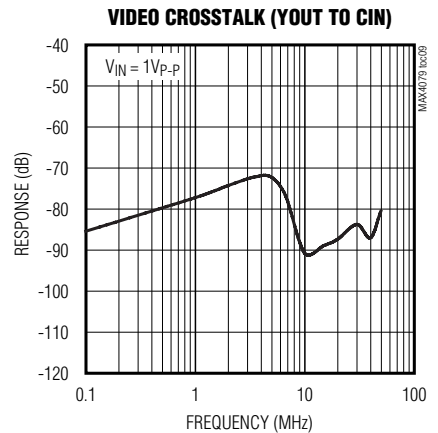
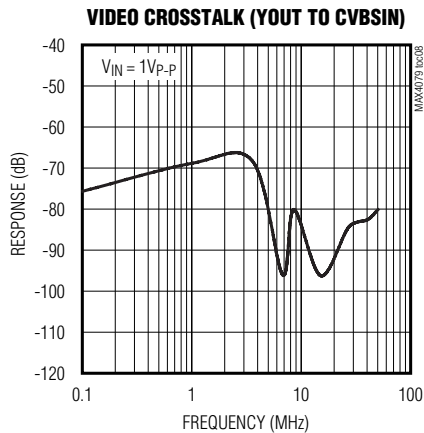
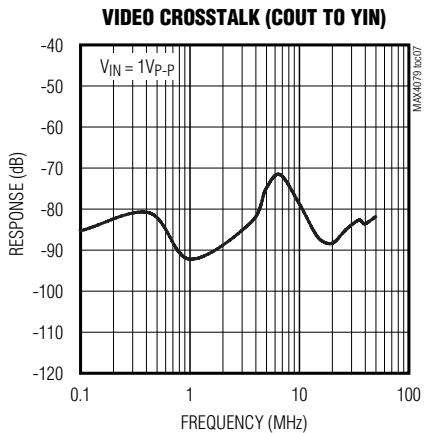
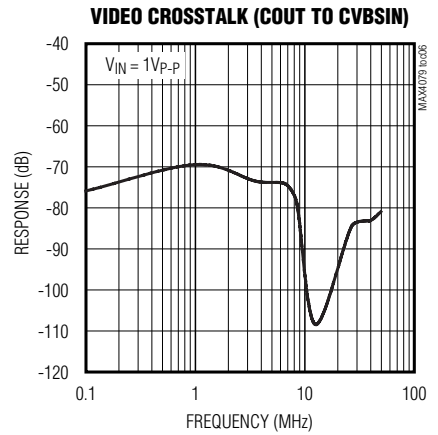
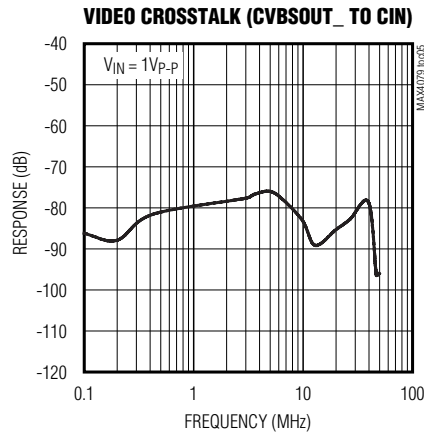
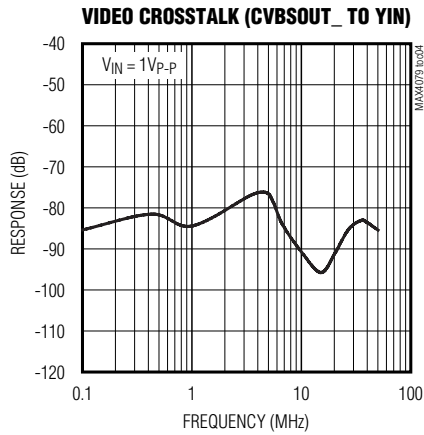

Complete Audio/Video Backend Solution

Typical Operating Characteristics (continued)

($V_{VID} = +5V$, $V_{AUDV} = +12V$, $V_{GVID} = V_{GAUD} = 0V$, $R_{IN_VIDEO} = 75\Omega$ to G_{VID} , $C_{IN_VIDEO} = 0.1\mu F$, $R_{LOAD_VID} = 150\Omega$ to G_{VID} , $C_{OUT_AUDIO} = 10\mu F$, $R_{LOAD_AUD} = 10k\Omega$ to G_{AUD} , $R_{REXT} = 10k\Omega$, $C_{BYPASS} = 1\mu F$, $T_A = +25^\circ C$, unless otherwise noted.)

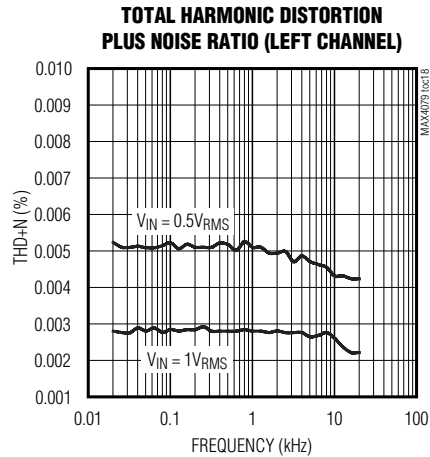
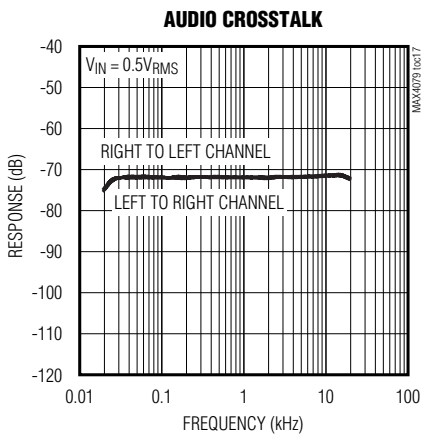
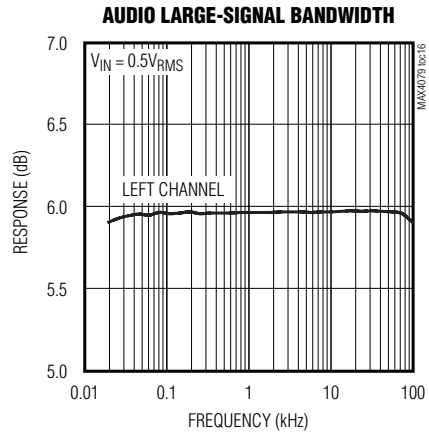
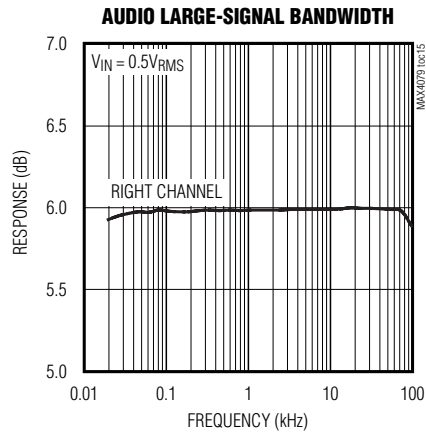
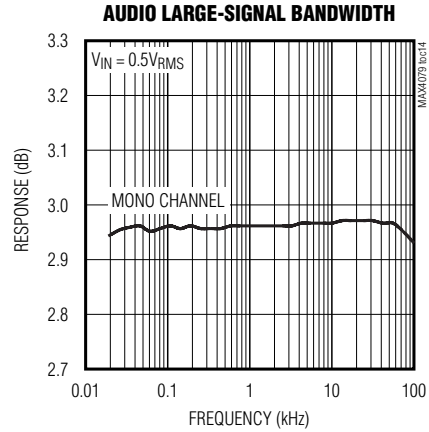
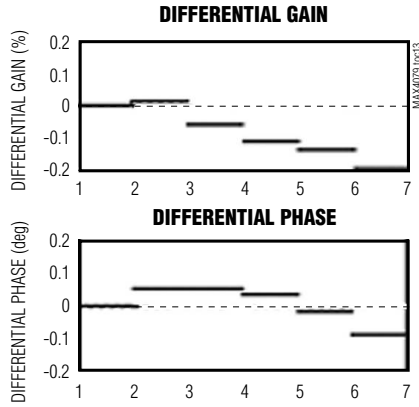

Complete Audio/Video Backend Solution

MAX4079

Typical Operating Characteristics (continued)

($V_{VID} = +5V$, $V_{AUDV} = +12V$, $V_{GVID} = V_{GAUD} = 0V$, $R_{IN_VIDEO} = 75\Omega$ to G_{VID} , $C_{IN_VIDEO} = 0.1\mu F$, $R_{LOAD_VID} = 150\Omega$ to G_{VID} , $C_{OUT_AUDIO} = 10\mu F$, $R_{LOAD_AUD} = 10k\Omega$ to G_{AUD} , $R_{REXT} = 10k\Omega$, $C_{BYPASS} = 1\mu F$, $T_A = +25^\circ C$, unless otherwise noted.)

TOTAL HARMONIC DISTORTION PLUS NOISE RATIO (RIGHT CHANNEL)

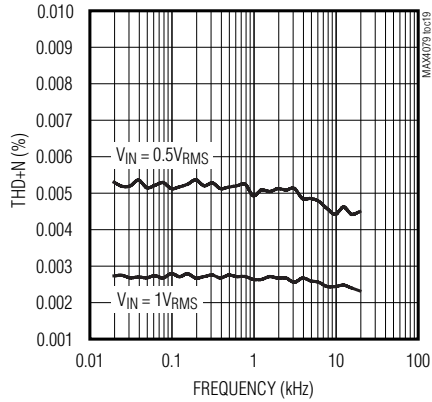

VIDEO SUPPLY CURRENT vs. TEMPERATURE

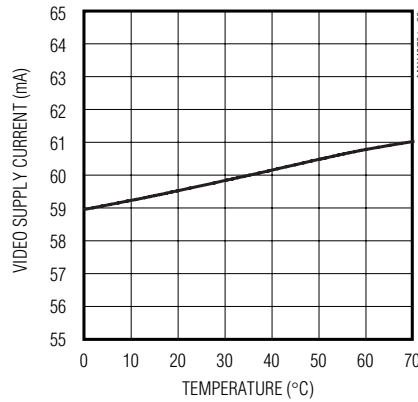

AUDIO SUPPLY CURRENT vs. TEMPERATURE

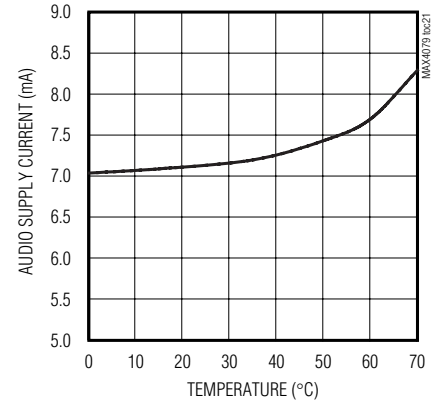

INPUT CLAMP CURRENT vs. TEMPERATURE

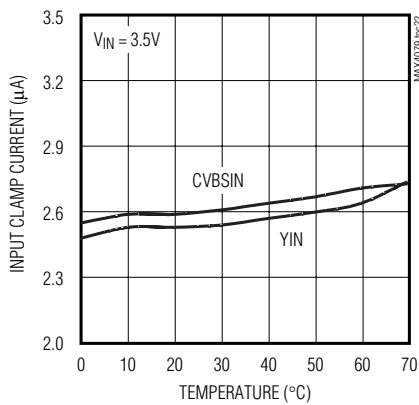

INPUT CLAMP CURRENT vs. INPUT VOLTAGE

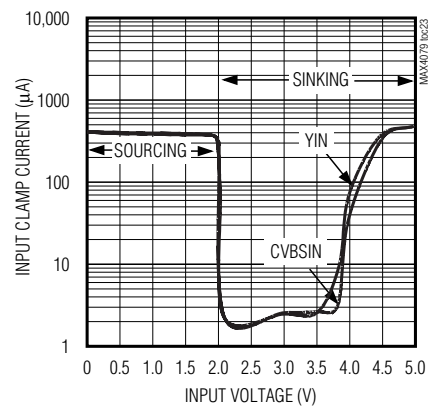

OUTPUT BIAS VOLTAGE vs. TEMPERATURE

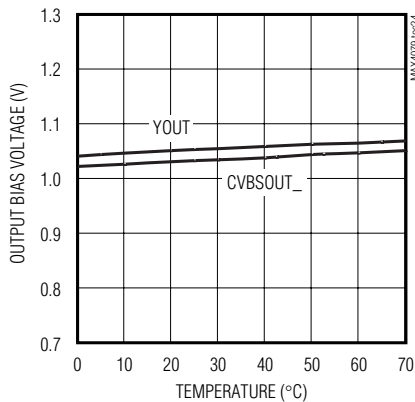

OUTPUT BIAS VOLTAGE vs. TEMPERATURE

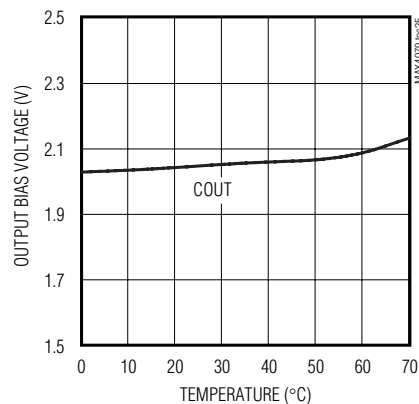

Complete Audio/Video Backend Solution

Pin Description

PIN	NAME	FUNCTION
1	REXT	External Filter Resistor. Bypass with a 10k Ω \pm 1% resistor and a 0.1 μ F capacitor to GVID.
2, 24	VVID	Video Power-Supply Input
3	CVBSIN	Composite Video Input
4, 21	GVID	Video Ground
5	YIN	Luma Input
6	CBYPASS	Audio LDO Regulator Bypass Capacitor. Bypass with a 1 μ F capacitor to GAUD.
7	CIN	Chroma Input
8	AUDV	Audio Power-Supply Input
9	LINP	Left-Channel Audio Positive Input
10	LINN	Left-Channel Audio Negative Input
11	RINN	Right-Channel Audio Negative Input
12	RINP	Right-Channel Audio Positive Input
13	ROUT2	Right-Channel Audio Output 2
14	ROUT1	Right-Channel Audio Output 1
15	GAUD	Audio Ground
16	MONO	Mono Audio Output
17	LOUT2	Left-Channel Audio Output 2
18	LOUT1	Left-Channel Audio Output 1
19	COUT	Chroma Video Output
20	YOUT	Luma Video Output
22	CVBSOUT1	Composite Video Output 1
23	CVBSOUT2	Composite Video Output 2

Detailed Description

The MAX4079 filters and buffers video (NTSC/PAL/DVB) and stereo audio signals from the MPEG decoder of a cable/satellite receiver, VCR/DVD player, or a TV to an external load. The MAX4079 has luma-chroma (Y-C) and composite (CVBS) video inputs with one Y-C and two CVBS outputs. All video inputs are AC-coupled with internal DC biasing on the chroma input and active clamps for the luma and composite.

The MAX4079 video reconstruction filters have a 6MHz cutoff frequency and 50dB attenuation at 27MHz. The filters are matched, with flat group delay for standard-definition video. The video gain is fixed at +6dB to drive a 75 Ω back-terminated load (150 Ω) to unity gain. The video outputs can be either DC- or AC-coupled and are powered by a single +5V supply.

The MAX4079 audio amplifiers have differential inputs for optimum performance, but can be used with single-ended sources with external biasing. The audio channels have a fixed gain of +6dB and deliver 2.6V_{RMS} output with a differential input of \pm 1.85V. The audio

amplifiers operate from a +9V to +12V single supply and feature an internal bias generator. An on-chip mixer also provides a mono output, with +3dB gain, derived from the left and right audio channels.

Video

The video section of the MAX4079 implements DC restore/biasing, amplification, and reconstruction filtering for the Y-C and CVBS input signals. All of the video inputs are AC-coupled. DC restore is performed using a sync tip clamp for both luma and composite video channels. The chroma DC level input is biased at the midlevel of the signal.

All video channels have a fixed gain of +6dB. The DC level at the video outputs is controlled so that coupling capacitors are not required.

All composite and luma video outputs are capable of driving 2.4V_{P-P}, and the chroma output is capable of driving 1.8V_{P-P} into 150 Ω resistive load to ground. Up to 35pF of load capacitance can be tolerated at each video output without stability or slew-rate issues.

Complete Audio/Video Backend Solution

MAX4079

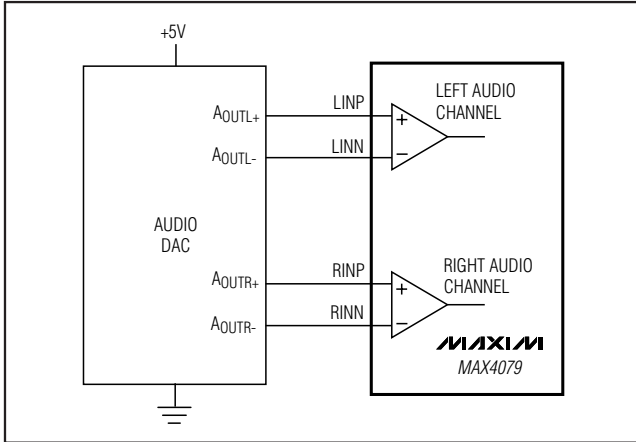

Figure 1. Differential Audio Inputs

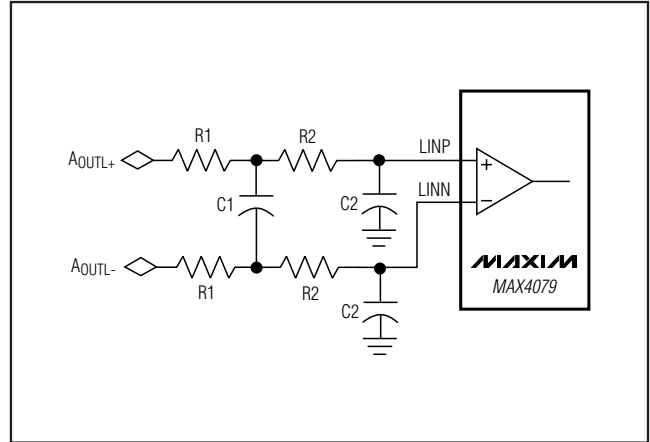

Figure 2. Filtering Differential Audio Inputs

All video inputs are stable with up to 150Ω source resistance. For higher values, consult Maxim applications.

Video Reconstruction Filter

The MAX4079 reconstruction filters are 4th-order Butterworth filters that provide a cutoff frequency of 6MHz and flat group delay response up to 4.5MHz. The stopband offers 26dB of attenuation at 13.5MHz and 50dB at 27MHz.

Audio

The audio section of the MAX4079 is a stereo amplifier with one differential input and two single-ended outputs for each channel (left and right). A mono output is provided by summing the two channels of the stereo signal together. The stereo channels have a +6dB typical gain, while the mono has a +3dB gain.

The audio inputs can be DC-coupled, eliminating space-consuming coupling capacitors. Each of the five outputs can deliver 2.6V_{RMS} into an AC-coupled 10kΩ load.

Applications Information

Audio DAC Interfacing

Differential Audio DAC

The MAX4079 accepts differential audio signals. Figure 1 shows a typical configuration for connecting the device to an audio DAC with differential outputs. Figure 2 shows the reconstruction filters that can be used for the differential audio inputs. Carefully select resistors and capacitors to attenuate out-of-band noise and mini-

mize the effect on the gain. The common-mode voltage for these signals is typically 2.5V.

Single-Ended Audio DAC

The MAX4079 can also be configured for single-ended inputs. Figure 3 shows how to connect an audio DAC with single-ended outputs to the MAX4079. Figure 4 shows how reconstruction filters can be used for single-ended audio inputs. Choose these values to minimize the effect on gain.

If the single-ended audio DAC does not include a common-mode voltage output, create a bias point with well-matched resistors and couple the audio signal to the positive differential input (see Figure 5). The bias point can also be created using a resistor-divider network from the video supply voltage. Note that the tolerance of the resistors will affect the common-mode and power-supply rejection ratios. Tighter tolerances improve the performance of CMRR and PSRR, e.g., 1% resistors will not give any better than 40dB of CMRR and PSRR, whereas 0.1% resistors could improve the number to 60dB.

Power Supplies and Bypassing

The MAX4079 features single +5V (video) and +12V (audio) supply operation, and requires no negative supply. Connect the VVID pins together and bypass to GVID with 0.01μF, 0.1μF, and 4.7μF capacitors in parallel. Bypass the AUDV to GAUD with 0.1μF, 1μF, and 47μF capacitors in parallel. Bypass CBYPASS to GAUD with a 1μF capacitor (see the *Typical Operating Circuit*).

Complete Audio/Video Backend Solution

Layout and Grounding

For optimal performance, stitch ground vias between the narrow adjacent signal traces to minimize crosstalk. Avoid running video traces parallel to high-speed data lines. The MAX4079 provides separate ground connections

for video and audio supplies. For best performance use separate ground planes for each of the ground returns, and connect all ground planes together at a single point. Refer to the MAX4079 Evaluation Kit for a proven circuit board layout example.

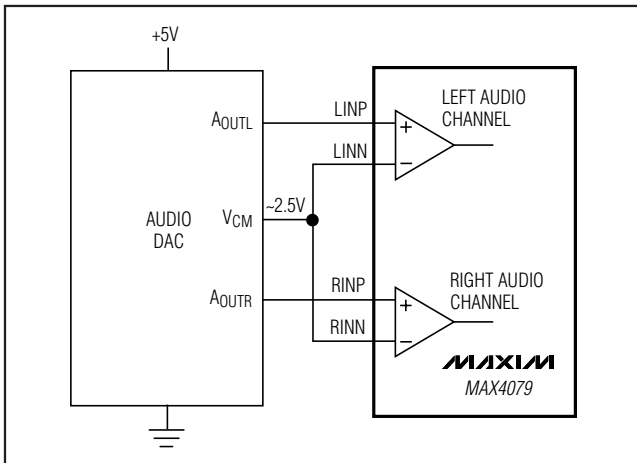

Figure 3. Single-Ended Audio Inputs

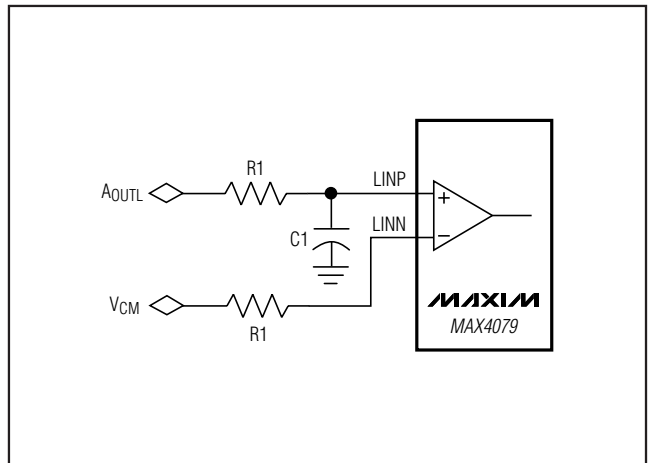

Figure 4. Filtering Single-Ended Audio Inputs

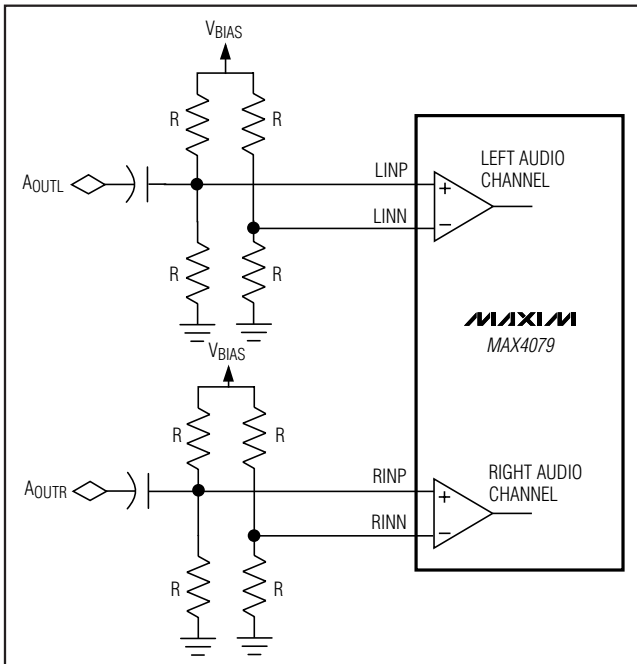

Figure 5. Biasing Single-Ended Audio Inputs

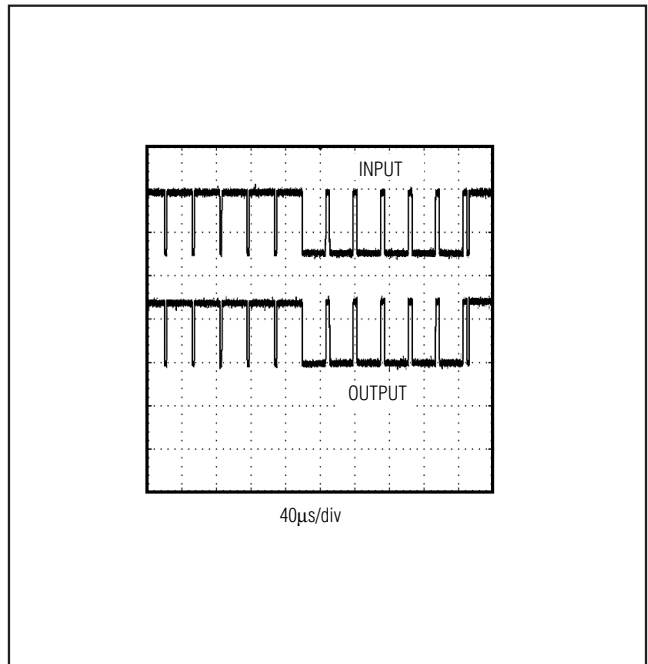
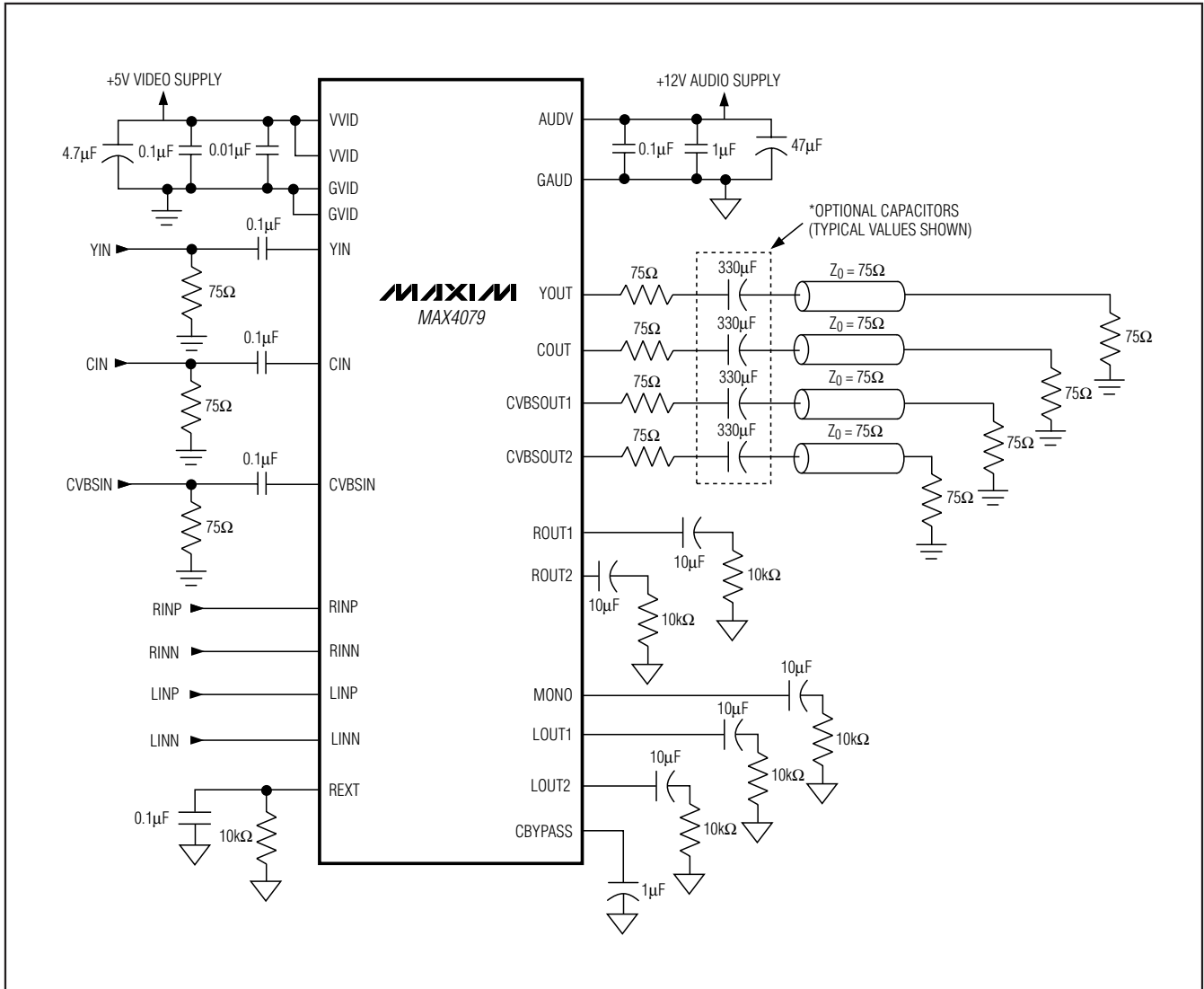

Figure 6. Vertical Sync Interval

Complete Audio/Video Backend Solution

Typical Operating Circuit

MAX4079



Complete Audio/Video Backend Solution

Pin Configuration

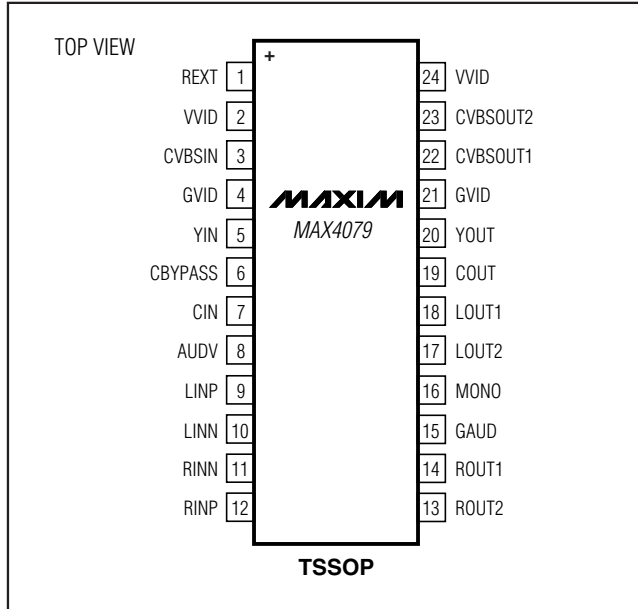

Chip Information

PROCESS: BiCMOS

Complete Audio/Video Backend Solution

Package Information

For the latest package outline information and land patterns, go to www.maxim-ic.com/packages.

MAX4079

PACKAGE TYPE	PACKAGE CODE	DOCUMENT NO.
24 TSSOP	U24+1	21-0066

TOP VIEW **BOTTOM VIEW** **BENT LEAD DETAIL**

SIDE VIEW **END VIEW**

DETAIL A **LEAD TIP DETAIL**

SYMBOL	COMMON DIMENSIONS			
	MILLIMETERS		INCHES	
	MIN.	MAX.	MIN.	MAX.
A	—	1.10	.002	.043
A ₁	0.05	0.15	.002	.006
A ₂	0.85	0.95	.033	.037
b	0.19	0.30	.007	.012
b ₁	0.19	0.25	.007	.010
c	0.09	0.20	.004	.008
c ₁	0.09	0.14	.004	.006
D	SEE VARIATIONS		SEE VARIATIONS	
E	4.30	4.50	.169	.177
e	0.65 BSC		.026 BSC	
H	6.25	6.55	.246	.258
L	0.50	0.70	.020	.028
N	SEE VARIATIONS		SEE VARIATIONS	
α	0°	8°	0°	8°
bbb	0.10 MAX			

JEDEC MD-153	N	PKG. CODES	VARIATIONS			
			MILLIMETERS		INCHES	
			MIN.	MAX.	MIN.	MAX.
AB-1	14	D U14-1; U14-2	4.90	5.10	.193	.201
AB	16	D U16-1; U16-2	4.90	5.10	.193	.201
AC	20	D U20-2; U20M-2; U20-3	6.40	6.60	.252	.260
AD	24	D U24-1	7.70	7.90	.303	.311
AE	28	D U28-1; U28-2; U28-3	9.60	9.80	.378	.386

NOTES

- DIMENSIONS D AND E DO NOT INCLUDE FLASH
- MOLD FLASH OR PROTRUSIONS NOT TO EXCEED 0.15mm PER SIDE
- CONTROLLING DIMENSION: MILLIMETER
- MEETS JEDEC OUTLINE MD-153. SEE JEDEC VARIATIONS TABLE
- "N" REFERS TO NUMBER OF LEADS
- LEAD COPLANARITY 0.10 MM MAX.
- NUMBER OF LEADS SHOWN ARE FOR REFERENCE ONLY
- MARKING IS FOR PACKAGE ORIENTATION REFERENCE ONLY
- BENT LEAD 0.10 MM MAX.
- ALL DIMENSIONS APPLY TO BOTH LEADED (-) AND PBFREE (+) PKG. CODES.

-DRAWING NOT TO SCALE-

MAXIM

TITLE:
PACKAGE OUTLINE,
TSSOP 4.40mm BODY

APPROVAL	DOCUMENT CONTROL NO. 21-0066	REV. J	1/1
----------	---------------------------------	--------	-----

TSSOP4.40mm.EPS

Complete Audio/Video Backend Solution

Package Information (continued)

For the latest package outline information and land patterns, go to www.maxim-ic.com/packages.

SOICW.EPS

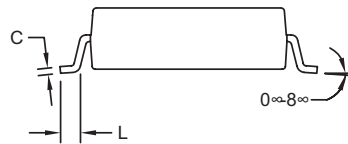
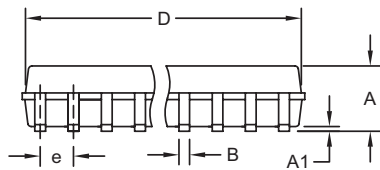
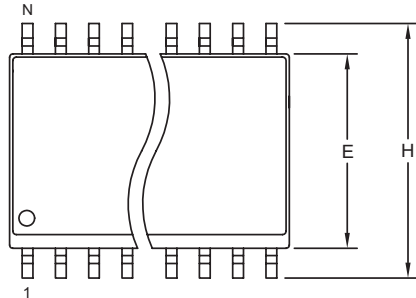

DIM	INCHES		MILLIMETERS	
	MIN	MAX	MIN	MAX
A	0.093	0.104	2.35	2.65
A1	0.004	0.012	0.10	0.30
B	0.014	0.019	0.35	0.49
C	0.009	0.013	0.23	0.32
e	0.050		1.27	
E	0.291	0.299	7.40	7.60
H	0.394	0.419	10.00	10.65
L	0.016	0.050	0.40	1.27

VARIATIONS:

DIM	INCHES		MILLIMETERS		N	MS013
	MIN	MAX	MIN	MAX		
D	0.398	0.413	10.10	10.50	16	AA
D	0.447	0.463	11.35	11.75	18	AB
D	0.496	0.512	12.60	13.00	20	AC
D	0.598	0.614	15.20	15.60	24	AD
D	0.697	0.713	17.70	18.10	28	AE

NOTES:

1. D&E DO NOT INCLUDE MOLD FLASH.
2. MOLD FLASH OR PROTRUSIONS NOT TO EXCEED 0.15mm (.006").
3. LEADS TO BE COPLANAR WITHIN 0.10mm (.004").
4. CONTROLLING DIMENSION: MILLIMETERS.
5. MEETS JEDEC MS013.
6. N = NUMBER OF PINS.

<small>PROPRIETARY INFORMATION</small>			
<small>TITLE:</small> PACKAGE OUTLINE, .300" SOIC			
<small>APPROVAL</small>	<small>DOCUMENT CONTROL NO.</small> 21-0042	<small>REV.</small> B	<small>1/1</small>

Complete Audio/Video Backend Solution

Revision History

REVISION NUMBER	REVISION DATE	DESCRIPTION	PAGES CHANGED
0	8/05	Initial release	—
1	3/09	Changes to remove SO package, style edits	1-7, 12, 13, 14

MAX4079

Maxim cannot assume responsibility for use of any circuitry other than circuitry entirely embodied in a Maxim product. No circuit patent licenses are implied. Maxim reserves the right to change the circuitry and specifications without notice at any time.

Maxim Integrated Products, 120 San Gabriel Drive, Sunnyvale, CA 94086 408-737-7600 _____ 15

© 2009 Maxim Integrated Products

Maxim is a registered trademark of Maxim Integrated Products, Inc.