



### General Description

- Trench Power AlphaMOS-II technology
- Low  $R_{DS(ON)}$
- Low  $C_{iss}$  and  $C_{rss}$
- High Current Capability
- RoHS and Halogen Free Compliant

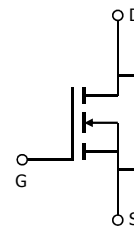
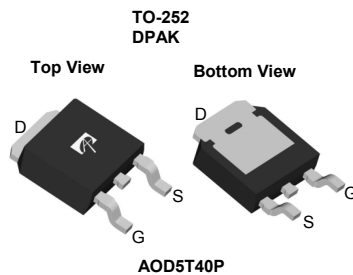
### Applications

- General Lighting for LED and CCFL
- AC/DC Power supplies for Industrial, Consumer, and Telecom

### Product Summary

$V_{DS} @ T_{j,max}$	500V
$I_{DM}$	15A
$R_{DS(ON),max}$	< 1.45 $\Omega$
$Q_{g,typ}$	5nC
$E_{oss} @ 320V$	0.9 $\mu$ J

100% UIS Tested  
100%  $R_g$  Tested



Orderable Part Number	Package Type	Form	Minimum Order Quantity
AOD5T40P	TO-252	Tape & Reel	2500

### Absolute Maximum Ratings $T_A=25^\circ\text{C}$ unless otherwise noted

Parameter	Symbol	Maximum	Units
Drain-Source Voltage	$V_{DS}$	400	V
Gate-Source Voltage	$V_{GS}$	$\pm 30$	V
Continuous Drain Current	$I_D$	$T_C=25^\circ\text{C}$	3.9
		$T_C=100^\circ\text{C}$	2.5
Pulsed Drain Current <sup>C</sup>	$I_{DM}$	15	A
Avalanche Current <sup>C</sup> $L=1\text{mH}$	$I_{AR}$	5	A
Repetitive avalanche energy <sup>C</sup>	$E_{AR}$	13	mJ
Single pulsed avalanche energy <sup>H</sup>	$E_{AS}$	108	mJ
MOSFET $dv/dt$ ruggedness	$dv/dt$	50	V/ns
Peak diode recovery $dv/dt$		5	
Power Dissipation <sup>B</sup>	$P_D$	$T_C=25^\circ\text{C}$	52
		Derate above $25^\circ\text{C}$	0.4
Junction and Storage Temperature Range	$T_J, T_{STG}$	-55 to 150	$^\circ\text{C}$
Maximum lead temperature for soldering purpose, 1/8" from case for 5 seconds	$T_L$	300	$^\circ\text{C}$

### Thermal Characteristics

Parameter	Symbol	Typical	Maximum	Units
Maximum Junction-to-Ambient <sup>A,D</sup>	$R_{\theta JA}$	45	55	$^\circ\text{C}/\text{W}$
Maximum Case-to-sink <sup>A</sup>	$R_{\theta CS}$	-	0.5	$^\circ\text{C}/\text{W}$
Maximum Junction-to-Case <sup>D,F</sup>	$R_{\theta JC}$	2	2.4	$^\circ\text{C}/\text{W}$

**Electrical Characteristics (T<sub>J</sub>=25°C unless otherwise noted)**

Symbol	Parameter	Conditions	Min	Typ	Max	Units
<b>STATIC PARAMETERS</b>						
BV <sub>DSS</sub>	Drain-Source Breakdown Voltage	I <sub>D</sub> =250μA, V <sub>GS</sub> =0V, T <sub>J</sub> =25°C	400			V
		I <sub>D</sub> =250μA, V <sub>GS</sub> =0V, T <sub>J</sub> =150°C		500		
BV <sub>DSS</sub> /ΔT <sub>J</sub>	Breakdown Voltage Temperature Coefficient	I <sub>D</sub> =250μA, V <sub>GS</sub> =0V		0.39		V/°C
I <sub>DSS</sub>	Zero Gate Voltage Drain Current	V <sub>DS</sub> =400V, V <sub>GS</sub> =0V			1	μA
		V <sub>DS</sub> =320V, T <sub>J</sub> =125°C			10	
I <sub>GSS</sub>	Gate-Body leakage current	V <sub>DS</sub> =0V, V <sub>GS</sub> =±30V			±100	nA
V <sub>GS(th)</sub>	Gate Threshold Voltage	V <sub>DS</sub> =5V, I <sub>D</sub> =250μA	3	4.2	5	V
R <sub>DS(on)</sub>	Static Drain-Source On-Resistance	V <sub>GS</sub> =10V, I <sub>D</sub> =1A		1.2	1.45	Ω
g <sub>FS</sub>	Forward Transconductance	V <sub>DS</sub> =40V, I <sub>D</sub> =1A		1.9		S
V <sub>SD</sub>	Diode Forward Voltage	I <sub>S</sub> =1A, V <sub>GS</sub> =0V		0.8	1	V
I <sub>S</sub>	Maximum Body-Diode Continuous Current				3.9	A
I <sub>SM</sub>	Maximum Body-Diode Pulsed Current <sup>C</sup>				15	A
<b>DYNAMIC PARAMETERS</b>						
C <sub>iss</sub>	Input Capacitance	V <sub>GS</sub> =0V, V <sub>DS</sub> =100V, f=1MHz		273		pF
C <sub>oss</sub>	Output Capacitance				16	
C <sub>o(er)</sub>	Effective output capacitance, energy related <sup>I</sup>	V <sub>GS</sub> =0V, V <sub>DS</sub> =0 to 320V, f=1MHz		18		pF
C <sub>o(tr)</sub>	Effective output capacitance, time related <sup>J</sup>				30	
C <sub>rss</sub>	Reverse Transfer Capacitance	V <sub>GS</sub> =0V, V <sub>DS</sub> =100V, f=1MHz		1.5		pF
R <sub>g</sub>	Gate resistance	f=1MHz		2.3		Ω
<b>SWITCHING PARAMETERS</b>						
Q <sub>g</sub>	Total Gate Charge	V <sub>GS</sub> =10V, V <sub>DS</sub> =320V, I <sub>D</sub> =3.9A		5	9	nC
Q <sub>gs</sub>	Gate Source Charge			1.8		nC
Q <sub>gd</sub>	Gate Drain Charge			1.4		nC
t <sub>D(on)</sub>	Turn-On DelayTime	V <sub>GS</sub> =10V, V <sub>DS</sub> =200V, I <sub>D</sub> =3.9A, R <sub>G</sub> =25Ω		17		ns
t <sub>r</sub>	Turn-On Rise Time			14		ns
t <sub>D(off)</sub>	Turn-Off DelayTime			18		ns
t <sub>f</sub>	Turn-Off Fall Time			9		ns
t <sub>rr</sub>	Body Diode Reverse Recovery Time	I <sub>F</sub> =3.9A, dI/dt=100A/μs, V <sub>DS</sub> =100V		172		ns
Q <sub>rr</sub>	Body Diode Reverse Recovery Charge	I <sub>F</sub> =3.9A, dI/dt=100A/μs, V <sub>DS</sub> =100V		1.1		μC

A. The value of R<sub>qJA</sub> is measured with the device in a still air environment with T<sub>A</sub>=25° C.

B. The power dissipation P<sub>D</sub> is based on T<sub>J(MAX)</sub>=150° C in a TO252 package, using junction-to-case thermal resistance, and is more useful in setting the upper dissipation limit for cases where additional heatsinking is used.

C. Repetitive rating, pulse width limited by junction temperature T<sub>J(MAX)</sub>=150° C.

D. The R<sub>qJA</sub> is the sum of the thermal impedance from junction to case R<sub>qJC</sub> and case to ambient.

E. The static characteristics in Figures 1 to 6 are obtained using <300μs pulses, duty cycle 0.5% max.

F. These curves are based on the junction-to-case thermal impedance which is measured with the device mounted to a large heatsink, assuming a maximum junction temperature of T<sub>J(MAX)</sub>=150° C.

G. These tests are performed with the device mounted on 1 in<sup>2</sup> FR-4 board with 2oz. Copper, in a still air environment with T<sub>A</sub>=25° C.

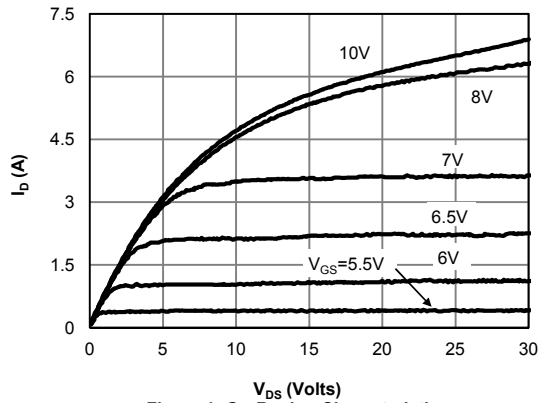
H. L=60mH, I<sub>AS</sub>=1.9A, V<sub>DD</sub>=150V, R<sub>G</sub>=10Ω, Starting T<sub>J</sub>=25° C.

I. C<sub>o(er)</sub> is a fixed capacitance that gives the same stored energy as C<sub>oss</sub> while V<sub>DS</sub> is rising from 0 to 80% V<sub>(BR)DSS</sub>.

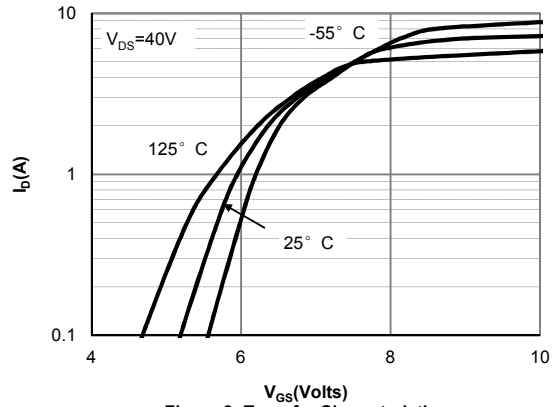
J. C<sub>o(tr)</sub> is a fixed capacitance that gives the same charging time as C<sub>oss</sub> while V<sub>DS</sub> is rising from 0 to 80% V<sub>(BR)DSS</sub>.

THIS PRODUCT HAS BEEN DESIGNED AND QUALIFIED FOR THE CONSUMER MARKET. APPLICATIONS OR USES AS CRITICAL COMPONENTS IN LIFE SUPPORT DEVICES OR SYSTEMS ARE NOT AUTHORIZED. AOS DOES NOT ASSUME ANY LIABILITY ARISING OUT OF SUCH APPLICATIONS OR USES OF ITS PRODUCTS. AOS RESERVES THE RIGHT TO IMPROVE PRODUCT DESIGN, FUNCTIONS AND RELIABILITY WITHOUT NOTICE.

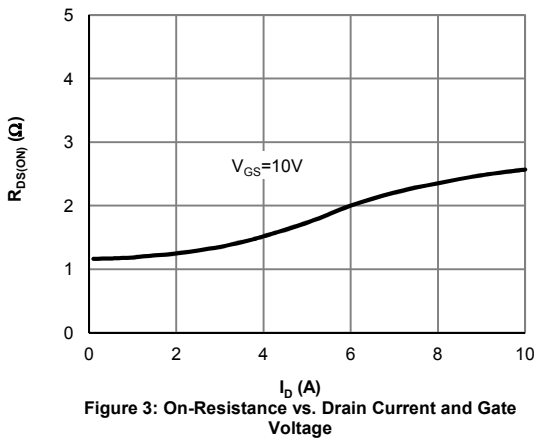
**TYPICAL ELECTRICAL AND THERMAL CHARACTERISTICS**



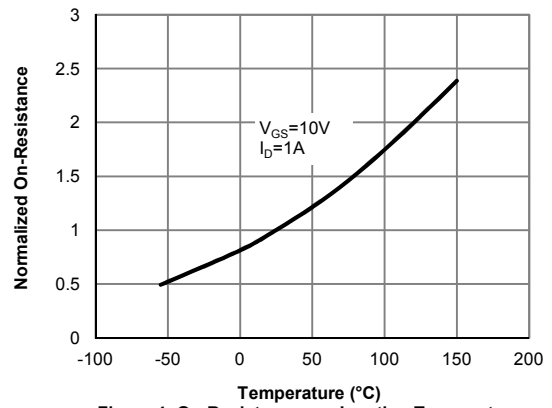
**Figure 1: On-Region Characteristics**



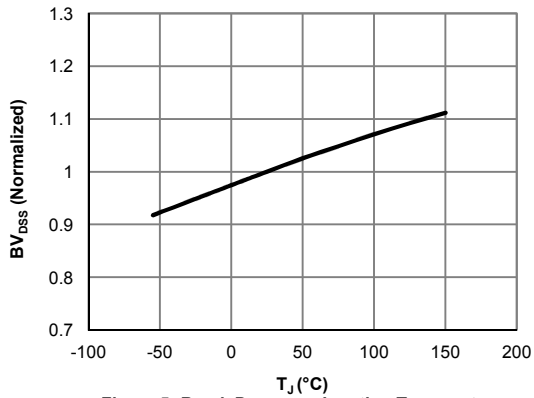
**Figure 2: Transfer Characteristics**



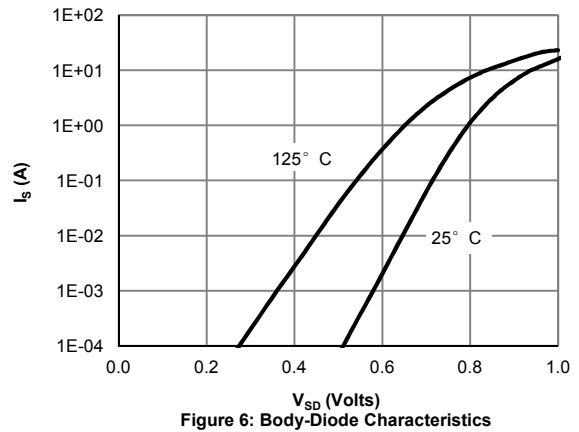
**Figure 3: On-Resistance vs. Drain Current and Gate Voltage**



**Figure 4: On-Resistance vs. Junction Temperature**



**Figure 5: Break Down vs. Junction Temperature**



**Figure 6: Body-Diode Characteristics**

**TYPICAL ELECTRICAL AND THERMAL CHARACTERISTICS**

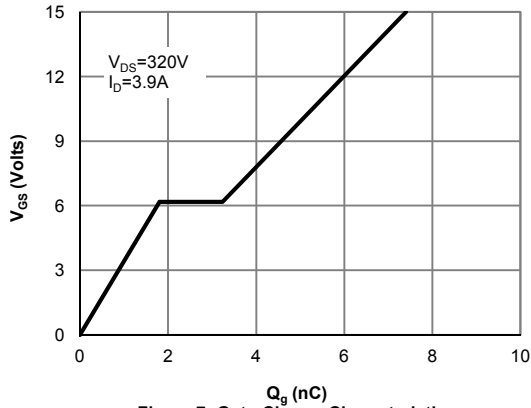


Figure 7: Gate-Charge Characteristics

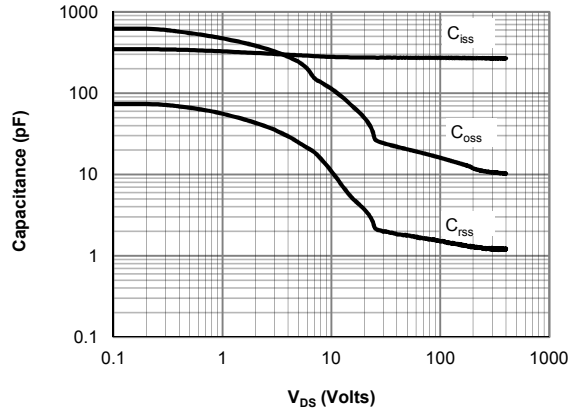


Figure 8: Capacitance Characteristics

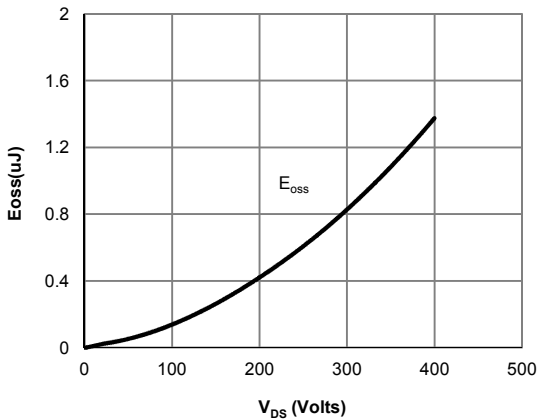


Figure 9: Coss stored Energy

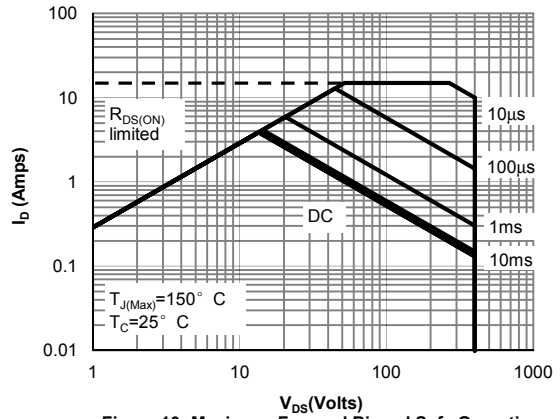


Figure 10: Maximum Forward Biased Safe Operating Area (Note F)

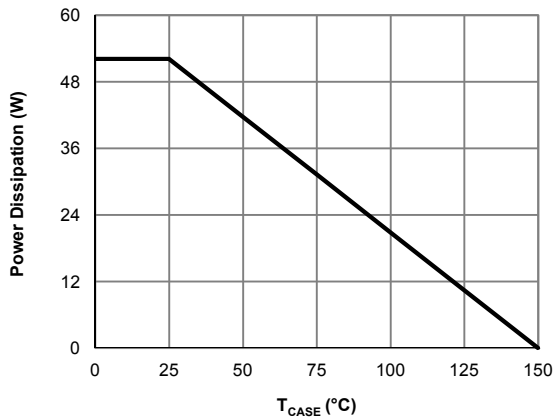


Figure 11: Power De-rating (Note B)

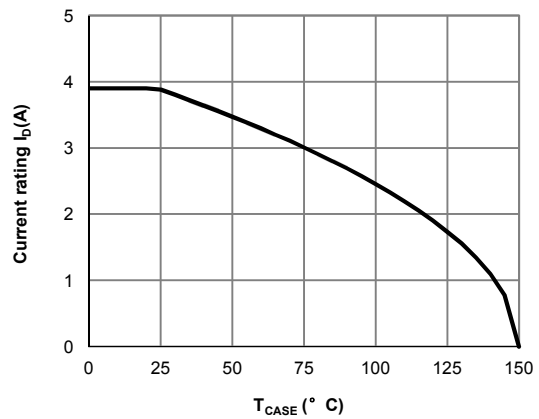
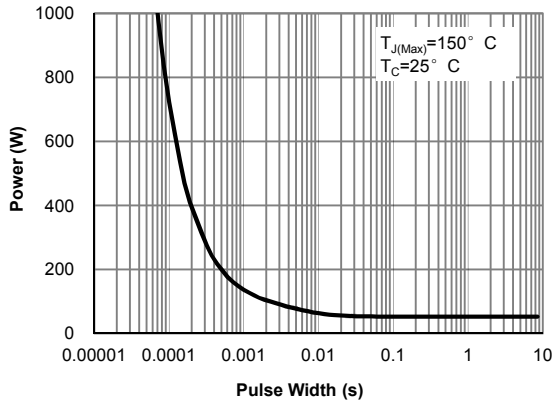
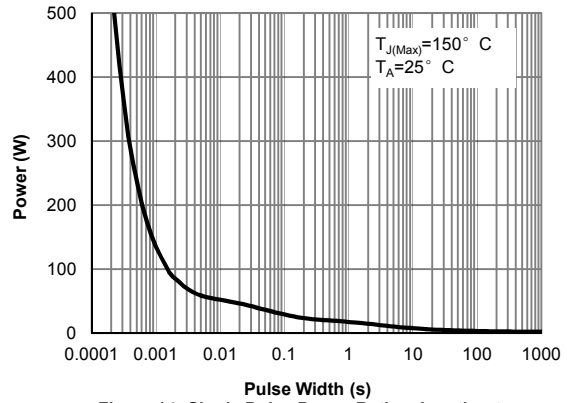


Figure 12: Current De-rating (Note F)

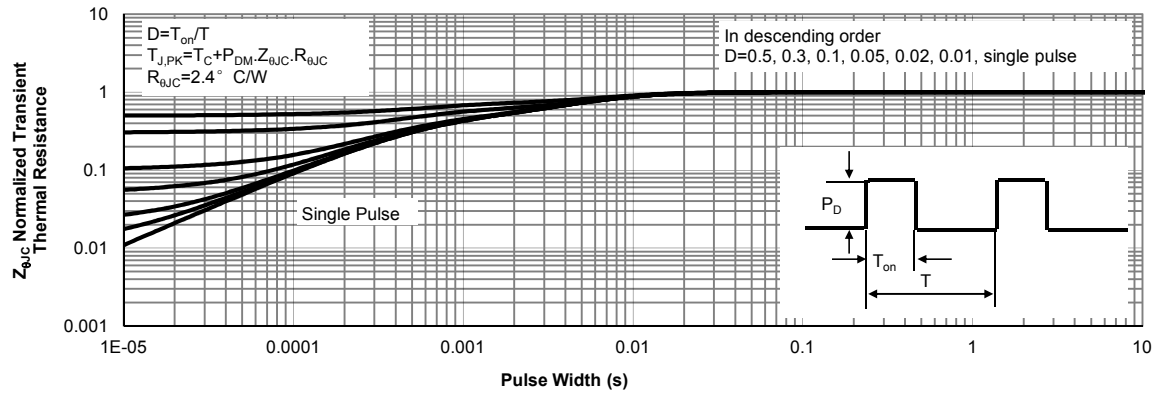
**TYPICAL ELECTRICAL AND THERMAL CHARACTERISTICS**



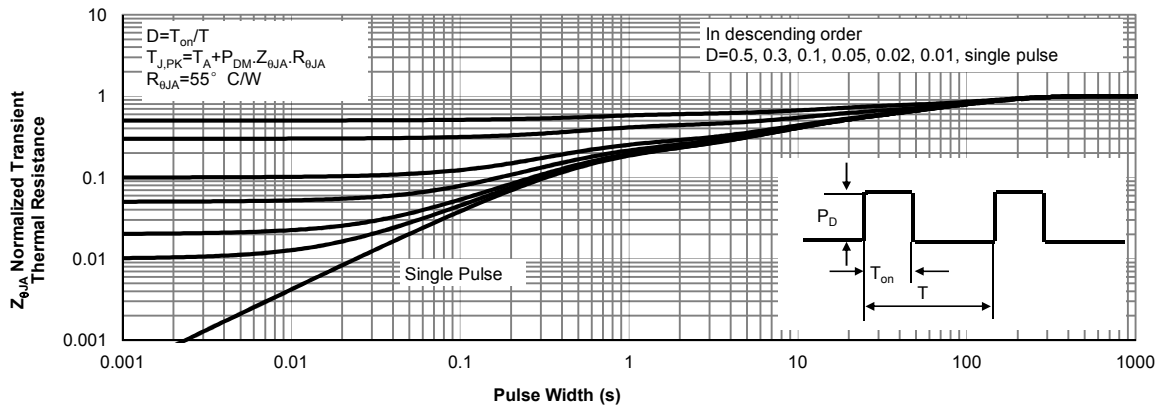
**Figure 13: Single Pulse Power Rating Junction-to-Case (Note F)**



**Figure 14: Single Pulse Power Rating Junction-to-Ambient (Note G)**

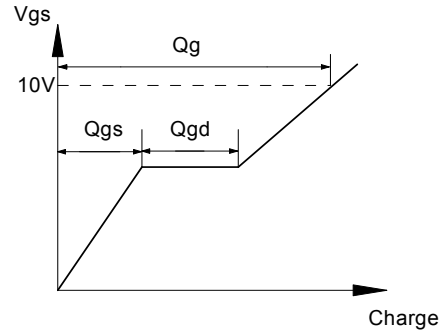
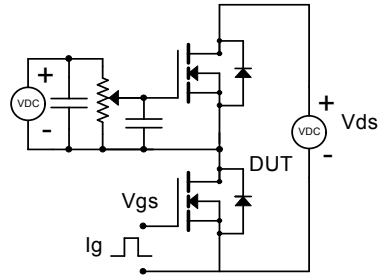


**Figure 15: Normalized Maximum Transient Thermal Impedance (Note F)**

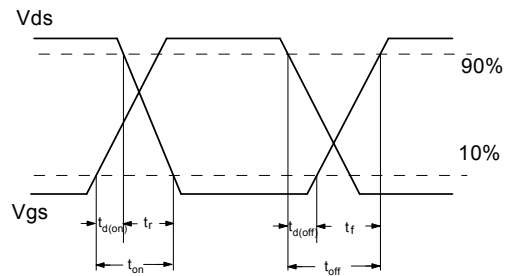
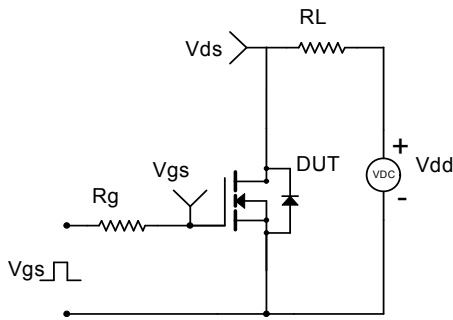


**Figure 16: Normalized Maximum Transient Thermal Impedance (Note G)**

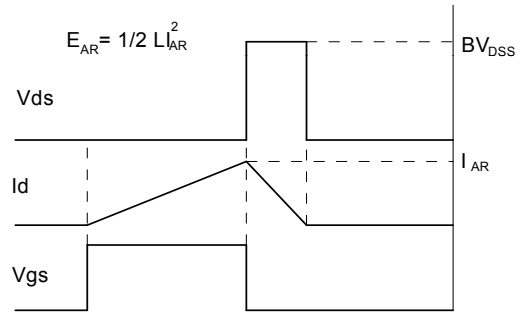
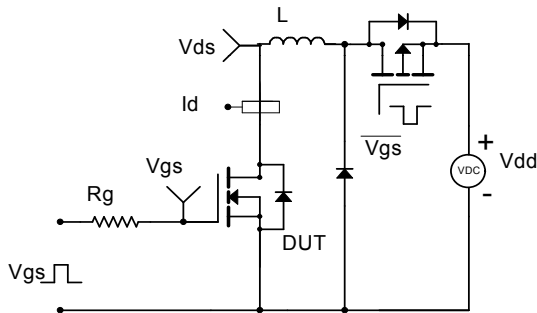
Gate Charge Test Circuit & Waveform



Resistive Switching Test Circuit & Waveforms



Unclamped Inductive Switching (UIS) Test Circuit & Waveforms



Diode Recovery Test Circuit & Waveforms

