

PE42823

Document Category: Product Specification

UltraCMOS® SPDT RF Switch, 700 MHz–6 GHz



Features

- Excellent single-event peak power handling of 51 dBm LTE
- Exceptional linearity performance across all frequencies
 - Input IP3: 70 dBm
 - Input IP2: 105 dBm
- Extended operating temperature of +105 °C
- 1.8V/3.3V TTL compatible control
- High ESD performance of 4.5 kV HBM on RF pins to ground
- Packaging – 16-lead 3 × 3 × 0.75 mm QFN

Applications

- 4G/4.5G wireless infrastructures
- Pre-5G/5G massive MIMO systems
- TDD-based RF transceivers

Figure 1 • PE42823 Functional Diagram

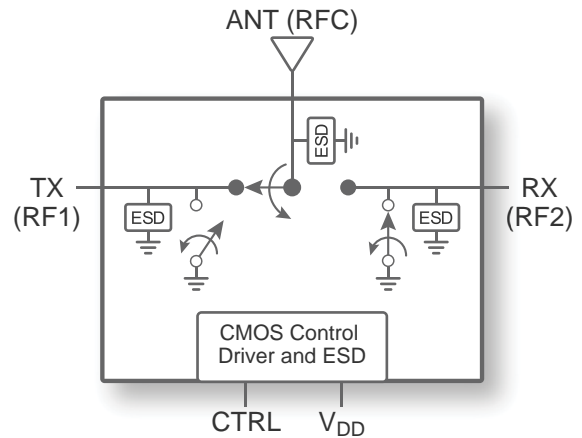

Product Description

The PE42823 is a HaRP™ technology-enhanced 50Ω SPDT RF protection switch designed for use in high power and high performance wireless infrastructure applications such as macrocells supporting frequencies up to 6 GHz.

This switch features high linearity, which remains invariant across the full supply range. The PE42823 also features exceptional isolation, fast switching time and is offered in a 16-lead 3 × 3 × 0.75 mm QFN package. In addition, no external blocking capacitors are required if 0 VDC is present on the RF ports.

The PE42823 is manufactured on Peregrine's UltraCMOS® process, a patented advanced form of silicon-on-insulator (SOI) technology.

Peregrine's HaRP technology enhancements deliver high linearity and excellent harmonics performance. It is an innovative feature of the UltraCMOS process, offering the performance of GaAs with the economy and integration of conventional CMOS.

Absolute Maximum Ratings

Exceeding absolute maximum ratings listed in **Table 1** may cause permanent damage. Operation should be restricted to the limits in **Table 2**. Operation between operating range maximum and absolute maximum for extended periods may reduce reliability.

ESD Precautions

When handling this UltraCMOS device, observe the same precautions as with any other ESD-sensitive devices. Although this device contains circuitry to protect it from damage due to ESD, precautions should be taken to avoid exceeding the rating specified in **Table 1**.

Latch-up Immunity

Unlike conventional CMOS devices, UltraCMOS devices are immune to latch-up.

Table 1 • Absolute Maximum Ratings for PE42823

Parameter	Condition	Min	Typ	Max	Unit
Power supply voltage		-0.3		5.5	V
Voltage on CTRL input		-0.3		3.6	V
Voltage on LS input		-0.3		3.6	V
Storage temperature range		-65		150	°C
Input power, avg: 700 –1800 MHz	Tx mode, 10-second duration, 8dB PAR LTE signal No power applied to off- terminated port. No hot switching.			43	dBm
1801–3800 MHz				42.5	dBm
3801–6000MHz				42	dBm
ESD voltage HBM: RF pins to GND	Human body model (MIL-STD 883 Method 3015).			4500	V
All pins				4000	V
ESD voltage CDM, all pins	Charged device model (JEDEC JESD22-C101).			1250	V

Recommended Operating Conditions

Table 2 lists the recommending operating conditions for the PE42823. Devices should not be operated outside the recommended operating conditions listed below.

Table 2 • Recommended Operating Conditions for PE42823

Parameter	Min	Typ	Max	Unit
Power supply voltage	2.3		5.5	V
Power supply current		120	200	μA
Control voltage high	1.17		3.6	V
Control voltage low	-0.3		0.6	V
Control current			10	μA
Operating temperature range	-40	+25	+105	°C

Electrical Specifications

Table 3 provides the PE42823 key electrical specifications @ +25 °C, $V_{DD} = 2.3\text{--}5.5\text{V}$, unless otherwise specified.

Table 3 • PE42823 Electrical Specifications

Parameter	Path	Condition	Min	Typ	Max	Unit
Operational frequency			700		6000	MHz
Insertion loss	ANT–RX	700 MHz		0.39	0.50	dB
		2100 MHz		0.51	0.60	dB
		2700 MHz		0.55	0.70	dB
		3800 MHz		0.68	0.85	dB
		6000 MHz		1.28	1.80	dB
	ANT–TX	700 MHz		0.25	0.35	dB
		2100 MHz		0.33	0.45	dB
		2700 MHz		0.36	0.50	dB
		3800 MHz		0.41	0.60	dB
		6000 MHz		0.53	0.80	dB
Isolation	ANT–RX	700 MHz	58	59		dB
		2100 MHz	46	47		dB
		2700 MHz	42	43		dB
		3800 MHz	37	38		dB
		6000 MHz	30	31		dB
	ANT–TX	700 MHz	47	48		dB
		2100 MHz	36	37		dB
		2700 MHz	33	34		dB
		3800 MHz	28	29		dB
		6000 MHz	22	23		dB
Return loss	ANT–RX	700–2700 MHz		24		dB
		2701–3800 MHz		17		dB
		3800–6000 MHz		12		dB
	ANT–TX	700–2700 MHz		26		dB
		2701–3800 MHz		26		dB
		3800–6000 MHz		28		dB
Input 1dB compression	ANT–TX	700–3800 MHz		46		dBm
		3801–6000 MHz		43		dBm
Input IP3	ANT–RX			70		dBm
Input IP2	ANT–RX			105		dBm
Max RF input power	Tx mode	Continuous Wave, –40°C to 105°C			38.5	dBm
	Rx mode	Continuous Wave, –40°C to 105°C			33	dBm
Settling time		50% CTRL to 0.05 dB final value (–40°C to +105°C) Rising Edge		2		μs
Settling time		50% CTRL to 0.05 dB final value (–40°C to +105°C) Falling Edge		0.58		μs
Switching time	ANT–RX	50% CTRL to 90% or 10% of final value		0.84		μs
	ANT–TX	50% CTRL to 90% or 10% of final value		0.62		μs

Control Logic

Table 4 provides the control logic truth table for the PE42823.

Table 4 • Truth Table for PE42823

CTRL	ANT-TX	ANT-RX
0	OFF	ON
1	ON	OFF

Pin Information

This section provides pinout information for the PE42823. Figure 2 shows the pin map of this device for the available package. Table 5 provides a description for each pin.

Figure 2 • Pin Configuration (Top View)

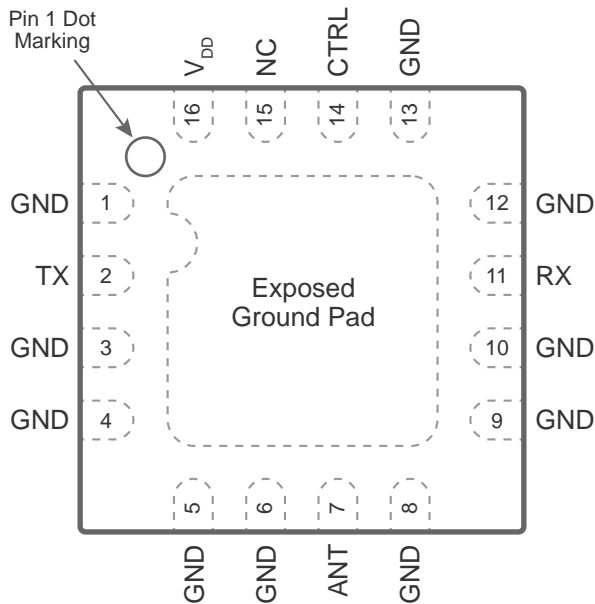

Table 5 • Pin Descriptions for PE42823

Pin No.	Pin Name	Description
1, 3, 4, 5, 6, 8, 9, 10, 12, 13	GND	Ground.
2	TX	TX RF port.
7	ANT	ANT RF port.
11	RX	RX RF port.
14	CTRL	Digital control logic input.
15	NC	NC
16	V _{DD}	Positive power supply voltage.

Note: * RF pins 2, 7 and 11 must be at 0 VDC. The RF pins do not require DC blocking capacitors for proper operation if the 0 VDC requirement is met.

Figure 3 • Insertion Loss vs Temp (RF1)

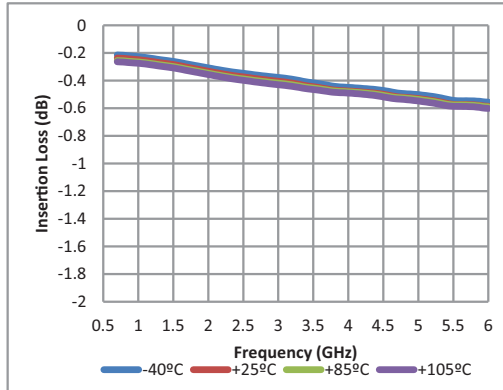

Figure 6 • Insertion Loss vs VDD (RF2)

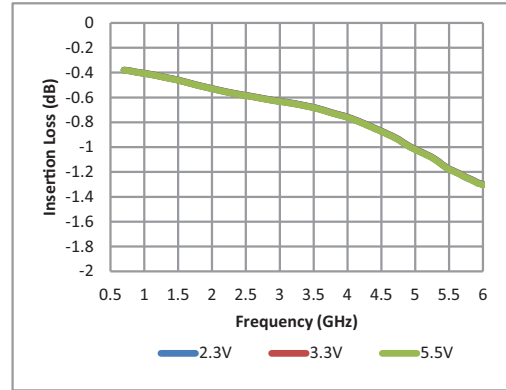

Figure 4 • Insertion Loss vs VDD (RF1)

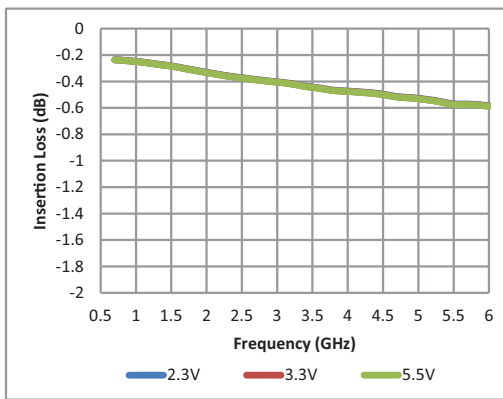

Figure 7 • RFC Port Return Loss vs Temp (RF1)

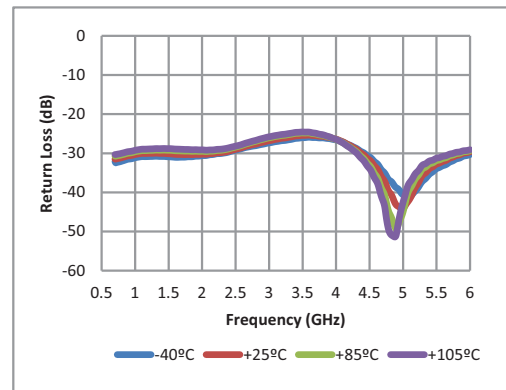

Figure 5 • Insertion Loss vs Temp (RF2)

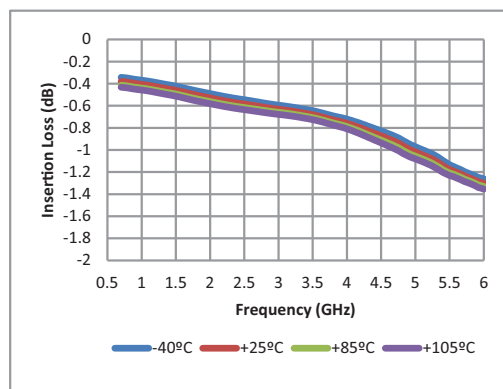

Figure 8 • RFC Port Return Loss vs Temp (RF2)

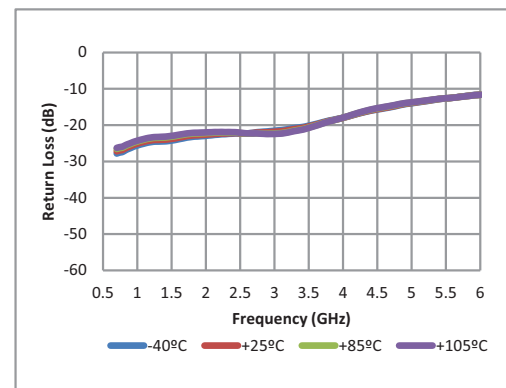

Figure 9 • Isolation vs Temp (RF1-RF2, RF1 Active)

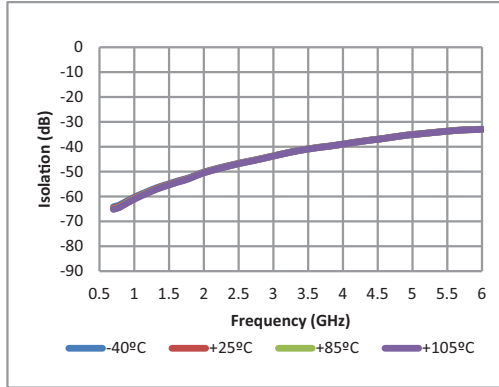

Figure 11 • Isolation vs Temp (RFC-RF1, RF2 Active)

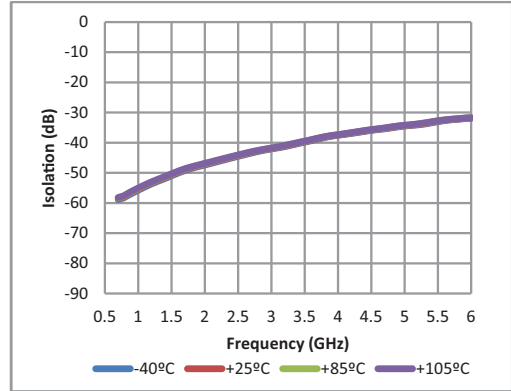
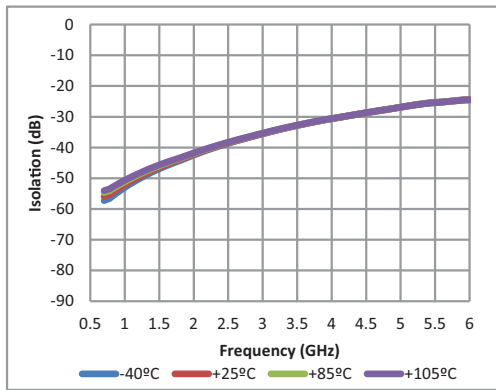
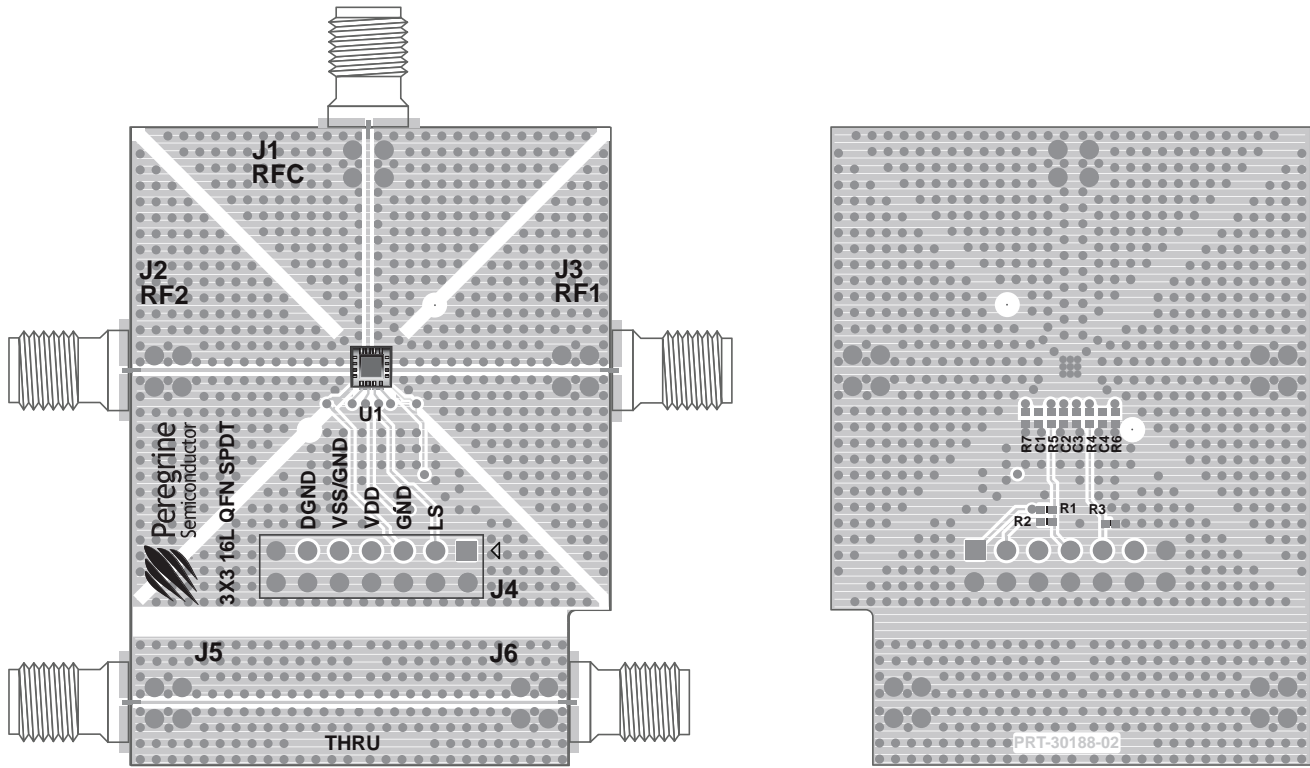

Figure 10 • Isolation vs Temp (RF2-RF1, RF2 Active)



Evaluation Board

Figure 12 • Evaluation Kit Layout for PE42823



Packaging Information

This section provides packaging data including the moisture sensitivity level, package drawing, package marking and tape-and-reel information.

Moisture Sensitivity Level

The moisture sensitivity level rating for the PE42823 in the 16-lead 3 × 3 × 0.75 mm QFN package is MSL1.

Package Drawing

Figure 13 • Package Mechanical Drawing for 16-lead 3 × 3 × 0.75 mm QFN

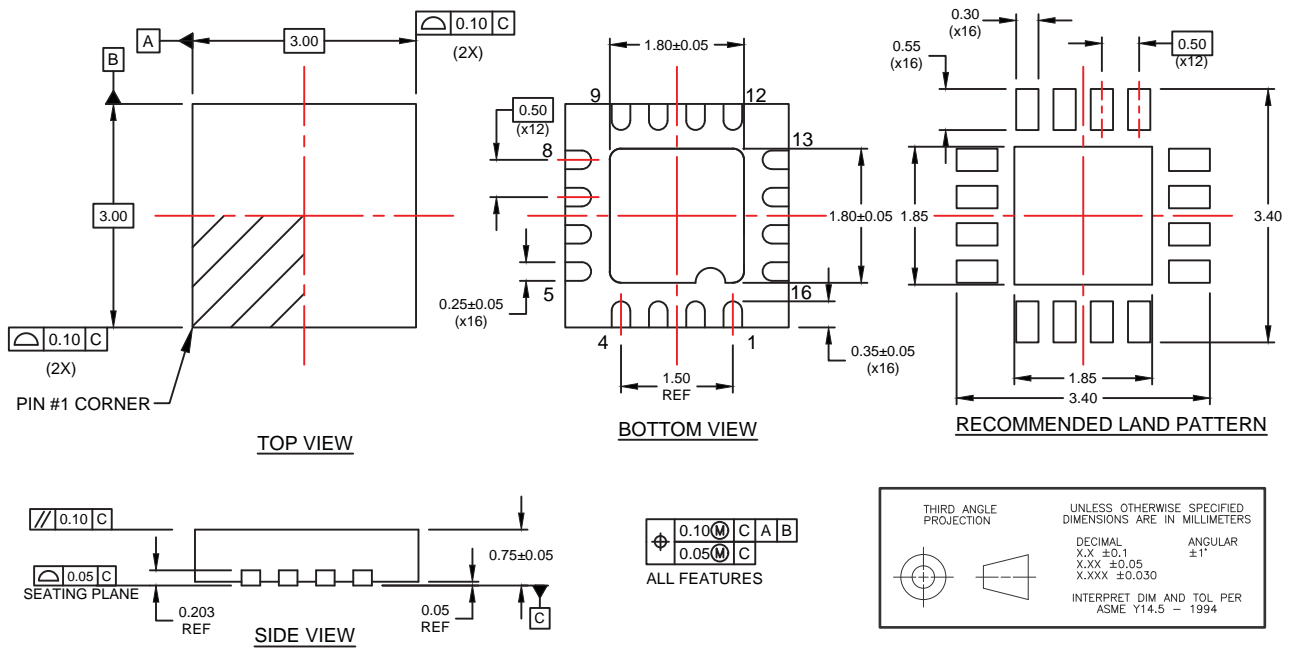

Top-Marking Specification

Figure 14 • Package Marking Specifications for PE42823

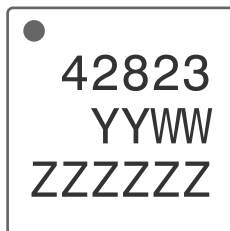

- = Pin 1 indicator
- YY = Last two digits of assembly year
- WW = Assembly work week
- ZZZZZZ = Assembly lot code (maximum six characters)

Tape and Reel Specification

Figure 15 • Tape and Reel Specifications for 16-lead 3 × 3 × 0.75 mm QFN

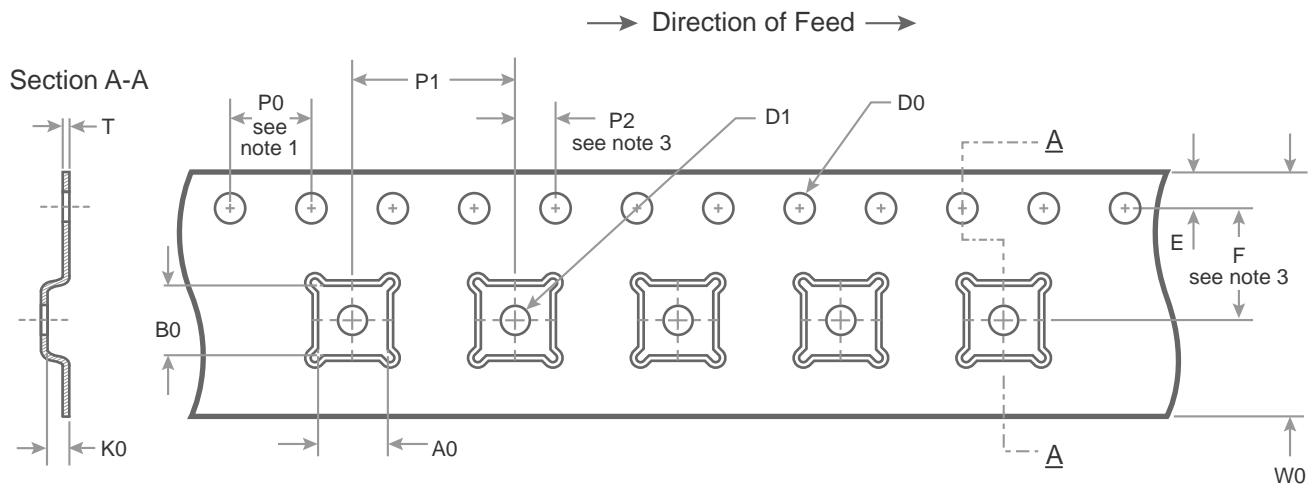

Notes:

1. 10 Sprocket hole pitch cumulative tolerance ± 0.2
2. Camber in compliance with EIA 481
3. Pocket position relative to sprocket hole measured as true position of pocket, not pocket hole

A0	3.30
B0	3.30
K0	1.10
D0	1.50 + 0.1/ -0.0
D1	1.5 min
E	1.75 ± 0.10
F	5.50 ± 0.05
P0	4.00
P1	8.00
P2	2.00 ± 0.05
T	0.30 ± 0.05
W0	12.00 ± 0.3

THIRD ANGLE PROJECTION

UNLESS OTHERWISE SPECIFIED DIMENSIONS ARE IN MILLIMETERS

DECIMAL	ANGULAR
X.X ± 0.1	± 1°
X.XX ± 0.05	
X.XXX ± 0.030	

INTERPRET DIM AND TOL PER ASME Y14.5 - 1994

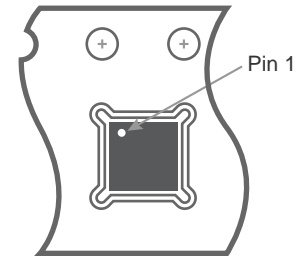

Device Orientation in Tape

Ordering Information

Table 6 lists the available ordering codes for the PE42823 as well as available shipping methods.

Table 6 • Order Codes for PE42823

Order Codes	Description	Packaging	Shipping Method
PE42823A–X	PE42823 SPDT RF switch	16-lead 3 × 3 × 0.75 mm QFN	500 units/T&R
EK42823–01	PE42823 Evaluation kit	Evaluation kit	1/Box

Document Categories

Advance Information

The product is in a formative or design stage. The datasheet contains design target specifications for product development. Specifications and features may change in any manner without notice.

Preliminary Specification

The datasheet contains preliminary data. Additional data may be added at a later date. Peregrine reserves the right to change specifications at any time without notice in order to supply the best possible product.

Product Specification

The datasheet contains final data. In the event Peregrine decides to change the specifications, Peregrine will notify customers of the intended changes by issuing a CNF (Customer Notification Form).

Sales Contact

For additional information, contact Sales at sales@psemi.com.

Disclaimers

The information in this document is believed to be reliable. However, Peregrine assumes no liability for the use of this information. Use shall be entirely at the user's own risk. No patent rights or licenses to any circuits described in this document are implied or granted to any third party. Peregrine's products are not designed or intended for use in devices or systems intended for surgical implant, or in other applications intended to support or sustain life, or in any application in which the failure of the Peregrine product could create a situation in which personal injury or death might occur. Peregrine assumes no liability for damages, including consequential or incidental damages, arising out of the use of its products in such applications.

Patent Statement

Peregrine products are protected under one or more of the following U.S. patents: patents.psemi.com

Copyright and Trademark

©2015 – 2017, Peregrine Semiconductor Corporation. All rights reserved. The Peregrine name, logo, UTSi and UltraCMOS are registered trademarks and HaRP, MultiSwitch and DuNE are trademarks of Peregrine Semiconductor Corp.