



# PBS-RB010SG2SS0BMA0Z

PBS

**PRESSURE SENSORS**

**SICK**  
Sensor Intelligence.



Illustration may differ



### Ordering information

Type	Part no.
PBS-RB010SG2SS0BMA0Z	6039121

Other models and accessories → [www.sick.com/PBS](http://www.sick.com/PBS)

### Detailed technical data

#### Features

<b>Medium</b>	Liquid, gaseous
<b>Pressure type</b>	Gauge pressure
<b>Measuring range</b>	0 bar ... 10 bar
<b>Process temperature</b>	-20 °C ... +85 °C
<b>Zero point adjustment</b>	Max. + 3 % of span
<b>Output signal</b>	1 x PNP + 4 mA ... 20 mA
<b>Rotatable housing</b>	Display against housing with electrical connection: 330 ° Housing against process connection: 320 °
<b>Display</b>	14-segment-LED, blue, 4-digits, height 9 mm, electronically turnable by 180 ° Accuracy: ≤ 1 % of span ± 1 digit Update: 1,000, 500, 200, 100 ms (adjustable)

#### Performance

<b>Non-linearity</b>	≤ ± 0.5 %, of span (Best Fit Straight Line, BFSL) according to IEC 61298-2
<b>Accuracy</b>	≤ ± 1 % of the span Including non-linearity, hysteresis, zero point and full scale error (corresponds to error of measurement as per IEC 61298-2)
<b>Setting accuracy of switching outputs</b>	≤ ± 0.5 % of span
<b>Response time</b>	3 ms
<b>Long-term drift/one-year stability</b>	≤ 0.2 % of the span according to IEC 61298-2
<b>Temperature coefficient in rated temperature range</b>	Mean TC of zero point: ≤ 0.2% of span / 10 K, Mean TC of span ≤ 0.2 % of span / 10 K
<b>Rated temperature range</b>	0 °C ... +80 °C
<b>Service life</b>	Minimum 100 Mio. life cycles

#### Mechanics/electronics

<b>Process connection</b>	G ¼ female
<b>Wetted parts</b>	Pressure connection: stainless steel 316L Pressure sensor: stainless steel 316L (for measurement ranges from 0 bar ... 10 bar rel stainless steel 13-8 PH)

<b>Internal transmission fluid</b>	Silicone oil (only with pressure ranges < 0 bar ... 10 bar and ≤ 0 bar abs ... 25 bar abs)
<b>Pressure port</b>	Standard
<b>Housing material</b>	Lower body: stainless steel 304, Plastic head: PC + ABS, Buttons: TPE-E, Display window: PC
<b>Electrical connection</b>	Round connector M12 x 1, 4-pin, IP 67
<b>Supply voltage</b>	15 V DC ... 35 V DC
<b>Power consumption</b>	45 mA (for configurations without analog output signal) 70 mA (for configurations with analog output signal)
<b>Total current consumption</b>	Max. 350 mA / 570 mA (incl. switching current)
<b>Electrical safety</b>	Protection class: III Overvoltage protection: 40 V DC Short-circuit protection: Q <sub>A</sub> , Q <sub>1</sub> , Q <sub>2</sub> towards M Reverse polarity protection: L <sup>+</sup> to M
<b>Insolation voltage</b>	500 V DC
<b>CE-conformity</b>	Pressure equipment directive: This instrument is a pressure accessory as defined by the directive 97/23/EC, EMC directive: 2004/108/EC, EN 61326-2-3
<b>Weight sensor</b>	Approx. 200 g
<b>Seal</b>	Without seal
<b>Enclosure rating</b>	IP 67
<b>Protection class III</b>	✓

Ambient data

<b>Ambient temperature</b>	-20 °C ... +80 °C
<b>Storage temperature</b>	-20 °C ... +80 °C
<b>Relative humidity</b>	≤ 90 %
<b>Shock load</b>	50 g according to IEC 60068-2-27 (mechanical shock)
<b>Vibration load</b>	10 g according to IEC 60068-2-6 (vibration under resonance)

Dimensional drawing (Dimensions in mm (inch))

G ¼ female EN 837

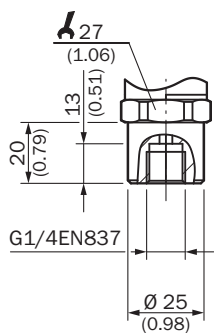

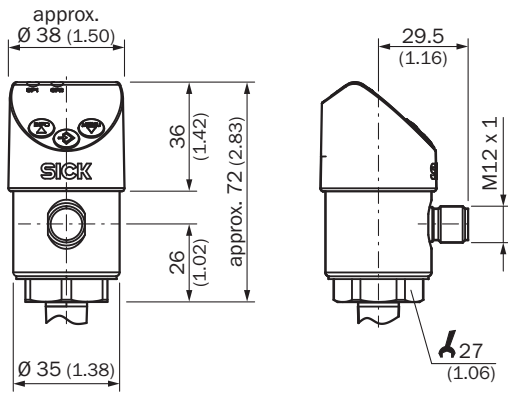

### Connection type

M12 x 1, 4-pin 2 switching outputs/  
1 switching output + 1 analog output

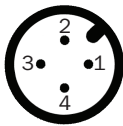

L<sup>+</sup> = 1, M = 3, Q<sub>1</sub> = 4, Q<sub>A</sub> = 2  
C/Q<sub>1</sub> = 4, Q<sub>A</sub> = 2

M12 x 1, 5-pin 2 switching outputs + 1 analog output

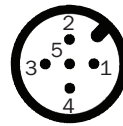



L<sup>+</sup> = 1, M = 3, Q<sub>1</sub> = 4, Q<sub>2</sub> = 2, Q<sub>A</sub> = 5  
C/Q<sub>1</sub> = 4

- ① L<sup>+</sup>: Positive supply connection
- ② M: Negative supply connection
- ③ Q<sub>1</sub>: Switching output 1
- ④ C/Q<sub>1</sub>: With IO-Link: Communication/ switching output 1
- ⑤ Q<sub>2</sub>: Switching output 2
- ⑥ Q<sub>A</sub>: Analog output

### Recommended accessories

Other models and accessories → [www.sick.com/PBS](http://www.sick.com/PBS)

	Brief description	Type	Part no.
<b>Mounting brackets and mounting plates</b>			
	Mounting bracket for simple and stable wall mounting of pressure sensors with 27 mm hexagon, Aluminum	BEF-FL-ALUPBS-HLDR	5322501
<b>Plug connectors and cables</b>			
	Head A: female connector, M12, 4-pin, straight Head B: cable Cable: PVC, unshielded, 2 m	DOL-1204-G02M	6009382
	Head A: female connector, M12, 4-pin, straight Head B: cable Cable: drag chain use, PUR, halogen-free, unshielded, 2 m	DOL-1204-G02MC	6025900

	Brief description	Type	Part no.
	Head A: female connector, M12, 4-pin, straight Head B: cable Cable: PVC, unshielded, 5 m	DOL-1204-G05M	6009866
	Head A: female connector, M12, 4-pin, straight Head B: cable Cable: drag chain use, PUR, halogen-free, unshielded, 5 m	DOL-1204-G05MC	6025901
	Head A: female connector, M12, 4-pin, straight Head B: cable Cable: PVC, unshielded, 10 m	DOL-1204-G10M	6010543
	Head A: female connector, M12, 4-pin, straight Head B: cable Cable: drag chain use, PUR, halogen-free, unshielded, 10 m	DOL-1204-G10MC	6025902
	Head A: female connector, M12, 4-pin, straight Head B: cable Cable: PVC, unshielded, 15 m	DOL-1204-G15M	6010753
	Head A: female connector, M12, 4-pin, straight Head B: cable Cable: PVC, unshielded, 20 m	DOL-1204-G20M	6034401
	Head A: female connector, M12, 4-pin, angled Head B: cable Cable: PVC, unshielded, 2 m	DOL-1204-W02M	6009383
	Head A: female connector, M12, 4-pin, angled Head B: cable Cable: drag chain use, PUR, halogen-free, unshielded, 2 m	DOL-1204-W02MC	6025903
	Head A: female connector, M12, 4-pin, angled Head B: cable Cable: PVC, unshielded, 5 m	DOL-1204-W05M	6009867
	Head A: female connector, M12, 4-pin, angled Head B: cable Cable: drag chain use, PUR, halogen-free, unshielded, 5 m	DOL-1204-W05MC	6025904
	Head A: female connector, M12, 4-pin, angled Head B: cable Cable: drag chain use, Welding spark resistant, PUR, halogen-free, unshielded, 5 m	DOL-1204-W05MD	6020399
	Head A: female connector, M12, 4-pin, angled Head B: cable Cable: PVC, unshielded, 10 m	DOL-1204-W10M	6010541
	Head A: female connector, M12, 4-pin, angled Head B: cable Cable: drag chain use, PUR, halogen-free, unshielded, 10 m	DOL-1204-W10MC	6025905
	Head A: female connector, M12, 4-pin, angled Head B: cable Cable: PVC, unshielded, 15 m	DOL-1204-W15M	6036474
	Head A: female connector, M12, 4-pin, angled Head B: cable Cable: PVC, unshielded, 20 m	DOL-1204-W20M	6033559

## SICK AT A GLANCE

SICK is one of the leading manufacturers of intelligent sensors and sensor solutions for industrial applications. A unique range of products and services creates the perfect basis for controlling processes securely and efficiently, protecting individuals from accidents and preventing damage to the environment.

We have extensive experience in a wide range of industries and understand their processes and requirements. With intelligent sensors, we can deliver exactly what our customers need. In application centers in Europe, Asia and North America, system solutions are tested and optimized in accordance with customer specifications. All this makes us a reliable supplier and development partner.

Comprehensive services complete our offering: SICK LifeTime Services provide support throughout the machine life cycle and ensure safety and productivity.

For us, that is “Sensor Intelligence.”

## WORLDWIDE PRESENCE:

Contacts and other locations –[www.sick.com](http://www.sick.com)