



High h_{FE} , Low-Frequency General-Purpose Amplifier Applications

2SC3650

FEATURES

- High DC current gain.
- Low collector-to-emitter saturation voltage.
- Large current capacity.
- Very small size making it easy to provide high-Density, small-sized hybrid IC's.



Lead-free

APPLICATIONS

LF amplifiers, various drivers, muting circuit

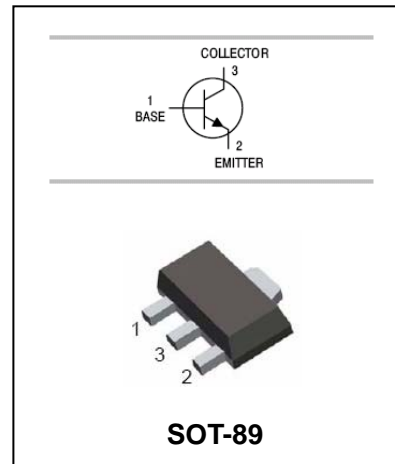

ORDERING INFORMATION

Type No.	Marking	Package Code
2SC3650	CF	SOT-89

MAXIMUM RATING @ $T_a=25^{\circ}\text{C}$ unless otherwise specified

Symbol	Parameter	Value	Units
V_{CBO}	Collector-Base Voltage	30	V
V_{CEO}	Collector-Emitter Voltage	25	V
V_{EBO}	Emitter-Base Voltage	15	V
I_C	Collector Current -Continuous	1.2	A
I_{CP}	Collector Current(Pulse)	2	A
P_C	Collector Dissipation	500	mW
T_j, T_{stg}	Junction and Storage Temperature	-55 to +150	$^{\circ}\text{C}$



High h_{FE} , Low-Frequency
General-Purpose Amplifier Applications

2SC3650

ELECTRICAL CHARACTERISTICS @ $T_a=25^\circ\text{C}$ unless otherwise specified

Parameter	Symbol	Test conditions	MIN	TYP	MAX	UNIT
Collector-base breakdown voltage	$V_{(BR)CBO}$	$I_C=10\mu\text{A}, I_E=0$	30			V
Collector-emitter breakdown voltage	$V_{(BR)CEO}$	$I_C=1\text{mA}, I_B=0$	25			V
Emitter-base breakdown voltage	$V_{(BR)EBO}$	$I_E=10\mu\text{A}, I_C=0$	15			V
Collector cut-off current	I_{CBO}	$V_{CB}=20\text{V}, I_E=0$			0.1	μA
Emitter cut-off current	I_{EBO}	$V_{EB}=10\text{V}, I_C=0$			0.1	μA
DC current gain	h_{FE}	$V_{CE}=5\text{V}, I_C=500\text{mA}$	800	1500	3200	
		$V_{CE}=5\text{V}, I_C=10\text{mA}$	600			
Collector-emitter saturation voltage	$V_{CE(sat)}$	$I_C=0.5\text{A}, I_B=0.01\text{A}$		0.12	0.5	V
Base-emitter saturation voltage	$V_{BE(sat)}$	$I_C=0.5\text{A}, I_B=0.01\text{A}$		0.85	1.2	V
Transition frequency	f_T	$V_{CE}=10\text{V}, I_C=50\text{mA}$		220		MHz
Collector output capacitance	C_{ob}	$V_{CB}=10\text{V}, I_E=0, f=1\text{MHz}$		17		pF

TYPICAL CHARACTERISTICS @ $T_a=25^\circ\text{C}$ unless otherwise specified

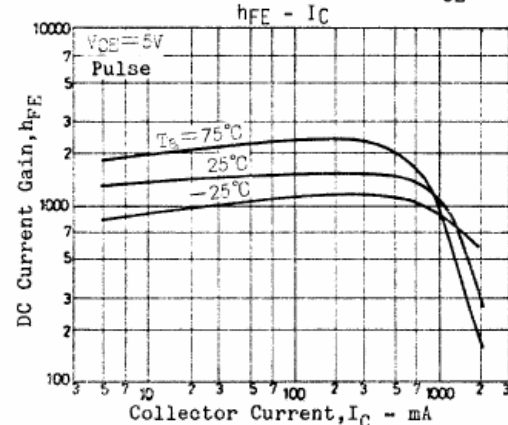
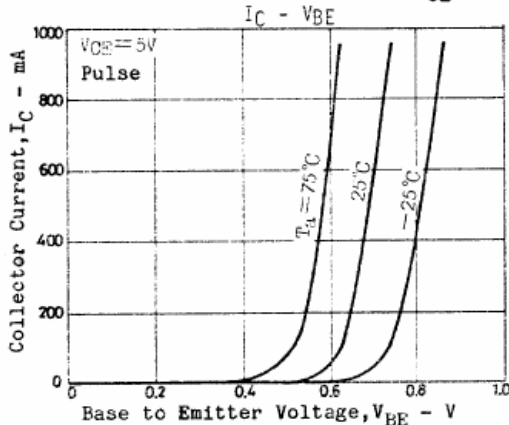
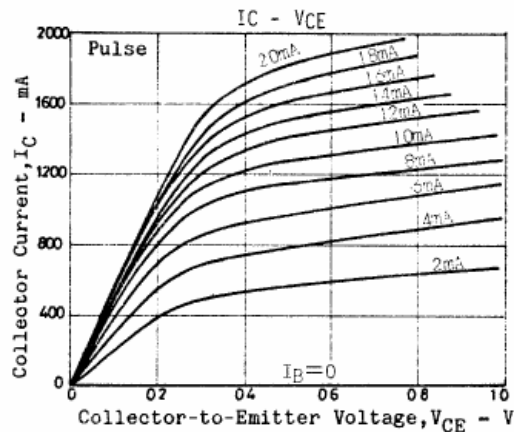
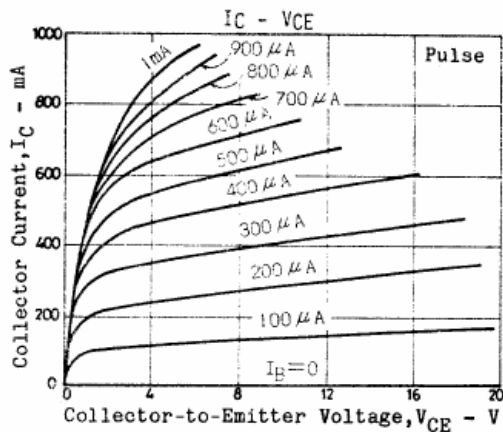



**High h_{FE} , Low-Frequency
General-Purpose Amplifier Applications**

2SC3650

PACKAGE OUTLINE

Plastic surface mounted package

SOT-89

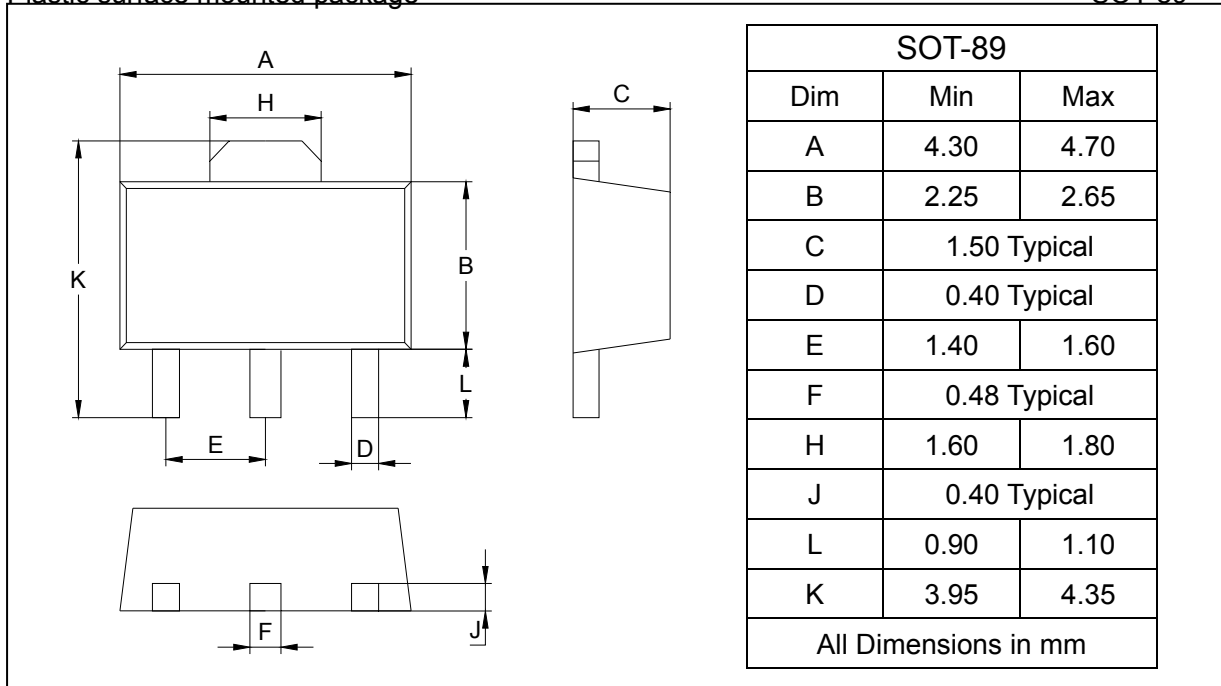

SOLDERING FOOTPRINT

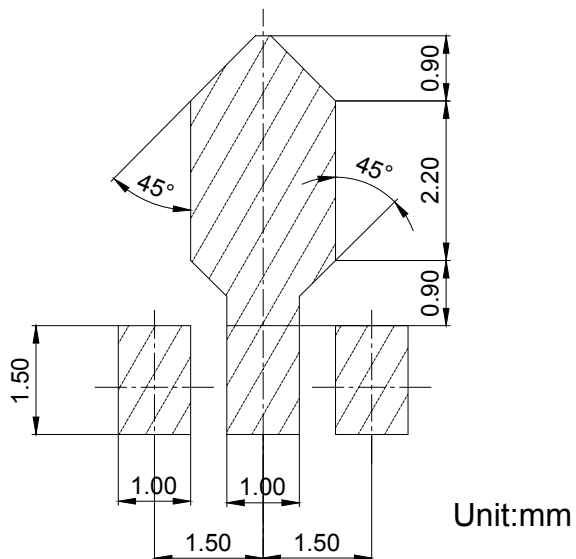

PACKAGE INFORMATION

Device	Package	Shipping
2SC3650	SOT-89	1000/Tape&Reel