

# TVS/ESD Arrays

RLST23A2.82LV Series

## TVS/ESD Arrays - RLST23A2.82LV Series

### Features

- 400 Watts peak pulse power ( $t_p = 8/20\mu s$ )
- Transient protection for high speed data lines to IEC 61000-4-2 (ESD)  $\pm 15kV$  (air),  $\pm 8kV$  (contact)  
IEC 61000-4-4 (EFT) 40A (5/50ns)  
IEC 61000-4-5 (Lightning) 24A (8/20 $\mu s$ )
- One device protects one unidirectional line
- Two devices protect two high-speed line pairs
- Low capacitance
- Low leakage current
- Low operating and clamping voltages
- Solid-state EPD TVS process technology



### Mechanical Characteristics

- SOT-23 package
- Molding compound flammability rating: UL 94V-0
- Packaging: Tape and Reel per EIA 481
- Lead Finish: Matte tin
- RoHS Compliant

### Applications

- 10/100 Ethernet
- WAN/LAN Equipment
- Switching Systems
- Desktops, Servers, Notebooks & Handhelds
- Laser Diode Protection
- Base Stations

### Life Support Note

- Not Intended for Use in Life Support or Life Saving Applications
- The products shown herein are not designed for use in life sustaining or life saving applications unless otherwise expressly indicated

### Pinout and Functional Block Diagram

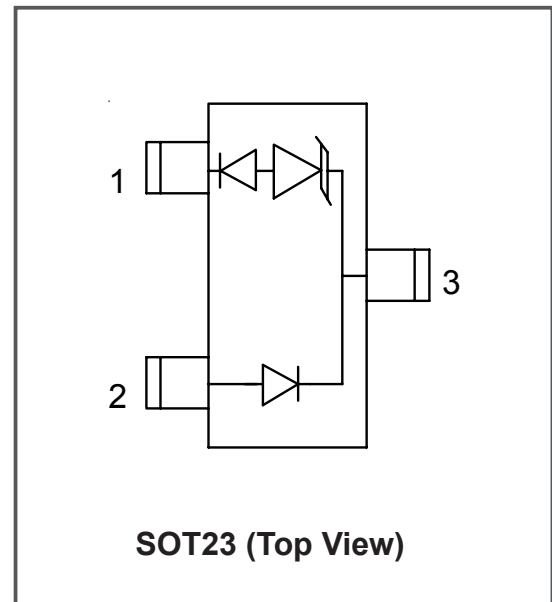

## TVS/ESD Arrays - RLST23A2.82LV Series

### Absolute Maximum Rating

Rating	Symbol	Value	Units
Peak Pulse Power ( $t_p = 8/20\mu s$ )	$P_{pk}$	400	Watts
Peak Pulse Current ( $t_p = 8/20\mu s$ )	$I_{pp}$	24	A
ESD per IEC 61000-4-2 (Air)	$V_{ESD}$	+/-15	Kv
ESD per IEC 61000-4-2 (Contact)	$V_{ESD}$	+/-8	Kv
Operating Temperature	$T_J$	-55 to +125	°C
Storage Temperature	$T_{STG}$	-55 to +150	°C

### Electrical Characteristics Per Lin (@ 25°C Unless Otherwise Specified)

Parameter	Symbol	Conditions	Minimum	Typical	Maximum	Units
Reverse Stand-Off Voltage	$V_{RWM}$	Pin 3 to 1 or Pin 2 to 1	-	-	2.8	V
Punch-Through Voltage	$V_{PT}$	$I_{pT} = 2\mu A$ , Pin 3 to 1	3.0	-	-	V
Snap-Back Voltage	$V_{SB}$	$I_{SB} = 50mA$ , Pin 3 to 1	2.8	-	-	V
Reverse Leakage Current	$I_R$	$V_{RWM} = 2.5V$ , $T = 25^\circ C$ Pin 3 to 1 or Pin 2 to 1	-	-	1	$\mu A$
Clamping Voltage	$V_C$	$I_{pp} = 1A$ , $t_p = 8/20\mu s$ Pin 3 to 1	-	-	3.9	V
Clamping Voltage	$V_C$	$I_{pp} = 5A$ , $t_p = 8/20\mu s$ Pin 3 to 1	-	-	7	V
Clamping Voltage	$V_C$	$I_{pp} = 1A$ , $t_p = 8/20\mu s$ Pin 3 to 1	-	-	12.5	V
Clamping Voltage	$V_C$	$I_{pp} = 1A$ , $t_p = 8/20\mu s$ Pin 2 to 1	-	-	8.5	V
Clamping Voltage	$V_C$	$I_{pp} = 1A$ , $t_p = 8/20\mu s$ Pin 2 to 1	-	-	15	V
Junction Capacitance	$C_j$	Pin 3 to 1 and 2 (Pin 1 and 2 tied together) $V_R = 0V$ , $f = 1MHz$	-	70	100	pF
Junction Capacitance	$C_j$	Pin 2 to 1 (pin 3 N.C.) $V_R = 0V$ , $f = 1MHz$	-	5	10	pF
Steering Diode Characteristics						
Reverse Breakdown Voltage	$V_{BR}$	$I_T = 10\mu A$ , Pin 3 to 2	40	-	-	V
Reverse Leakage Current	$I_{RD}$	$V_{RWM} = 2.5V$ , $T = 25^\circ C$ Pin 3 to 2	-	-	1	$\mu A$
Forward Voltage	$V_F$	$I_F = 1A$ , Pin 2 to 3	-	-	2	V

## TVS/ESD Arrays - RLST23A2.82LV Series

### Typical Characteristics

Non-Repetitive Peak Pulse Power vs. Pulse Time

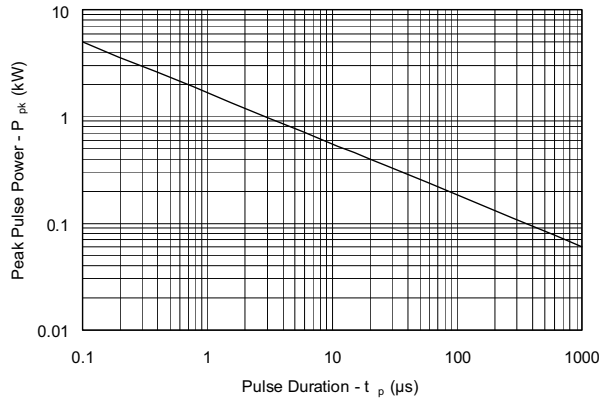

Power Derating Curve

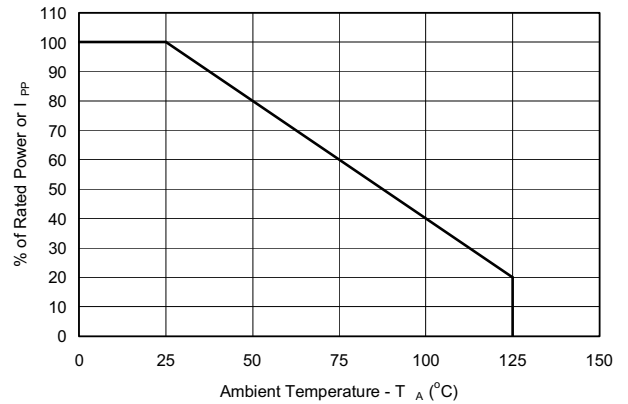

Pulse Waveform

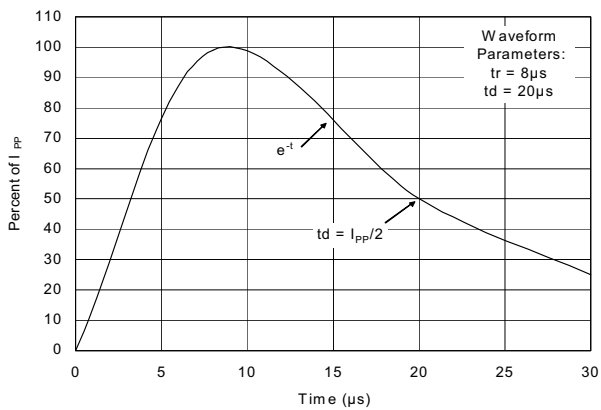

Clamping Voltage vs. Peak Pulse Current

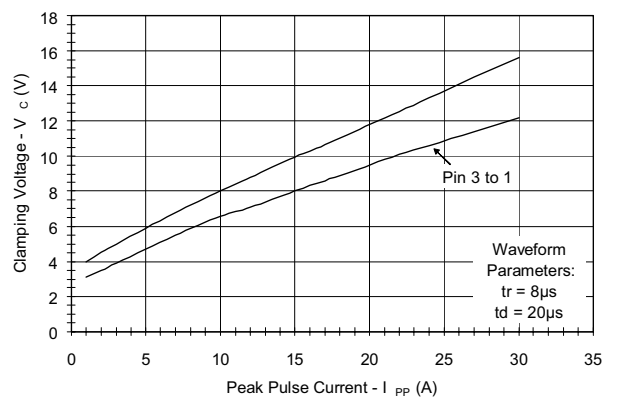

Forward Voltage vs. Forward Current

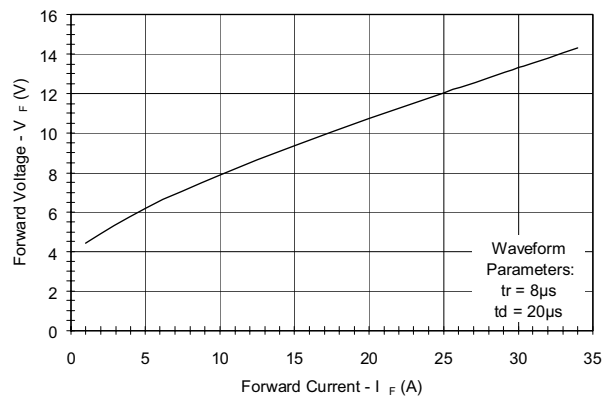

Normalized Capacitance vs. Reverse Voltage

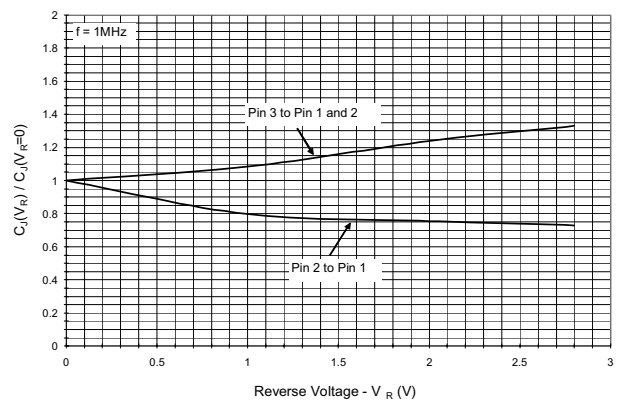

## TVS/ESD Arrays - RLST23A2.82LV Series

### Applications Information

#### Device Connection Options

Electronic equipment is susceptible to transient disturbances from a variety of sources including: ESD to an open connector or interface, direct or nearby lightning strikes to cables and wires, and charged cables "hot plugged" into I/O ports. The RLST23A2.82LV is designed to protect sensitive components from damage and latchup which may result from such transient events. The RLST23A2.82LV can be configured to protect either one unidirectional line or two (one line pair) high-speed data lines. The options for connecting the devices are as follows:

1. Protection of one unidirectional I/O line: Protection of one data line is achieved by connecting pin 3 to the protected line, and pins 1 and 2 to ground. This connection option will allow the device to operate on lines with positive polarity signal transitions (during normal operation). In this configuration, the device adds a maximum loading capacitance of 100pF. During positive duration transients, the internal TVS diode will be reversed biased and will act in the avalanche mode, conducting the transient current from pin 3 to 1. The transient will be clamped at or below the rated clamping voltage of the device. For negative duration transients, the internal steering diode is forward biased, conducting the transient current from pin 2 to 3. The transient is clamped below the rated forward voltage drop of the diode.

2. Low capacitance protection of one differential line pair: Protection of a high-speed differential line pair is achieved by connecting two devices in antiparallel. Pin 1 of the first device is connected to line 1 and pin 2 is connected to line 2. Pin 2 of the second device is connected to line 1 and pin 1 is connected to line 2 as shown. Pin 3 must be left open on both devices. During negative duration transients, the first device will conduct from pin 2 to 1. The steering diode conducts in the forward direction while the TVS will avalanche and conduct in the reverse direction. During positive transients, the second device will conduct in the same manner. In this configuration, the total loading capacitance is the sum of the capacitance (between pins 1 and 2) of each device (typically <10pF) making this configuration suitable for high-speed interfaces such as 10/100 Ethernet (See application note SI98-02).

#### RLST23A2.82LV Circuit Diagram

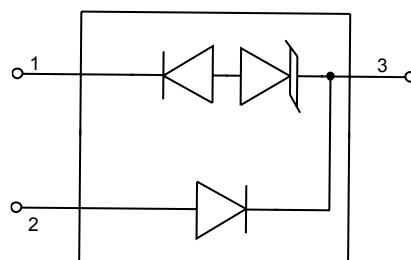

#### Protection of one unidirectional line

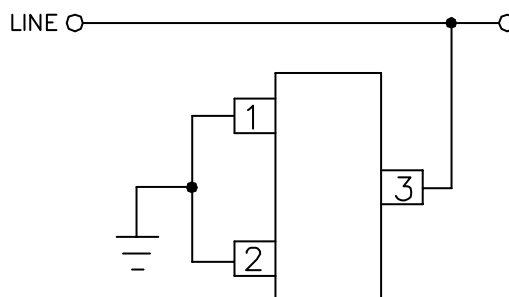

#### Low capacitance protection of one high-speed line pair

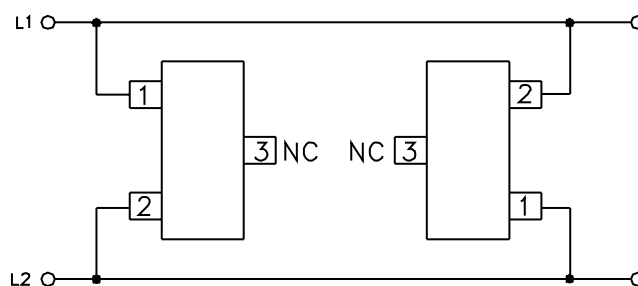

#### EPD TVS Characteristics

The RLST23A2.82LV is constructed using Semtech's proprietary EPD technology. The structure of the EPD TVS is vastly different from the traditional pn-junction devices. At voltages below 5V, high leakage current and junction capacitance render conventional avalanche technology impractical for most applications. However, by utilizing the EPD technology, the RLST23A2.82LV can effectively operate at 2.8V while maintaining excellent electrical characteristics.

The EPD TVS employs a complex nppn structure in contrast to the pn structure normally found in traditional silicon-avalanche TVS diodes. The EPD mechanism is achieved by engineering the center region of the device such that the reverse biased junction does

## TVS/ESD Arrays - RLST23A2.82LV Series

### Package dimension SOT-23

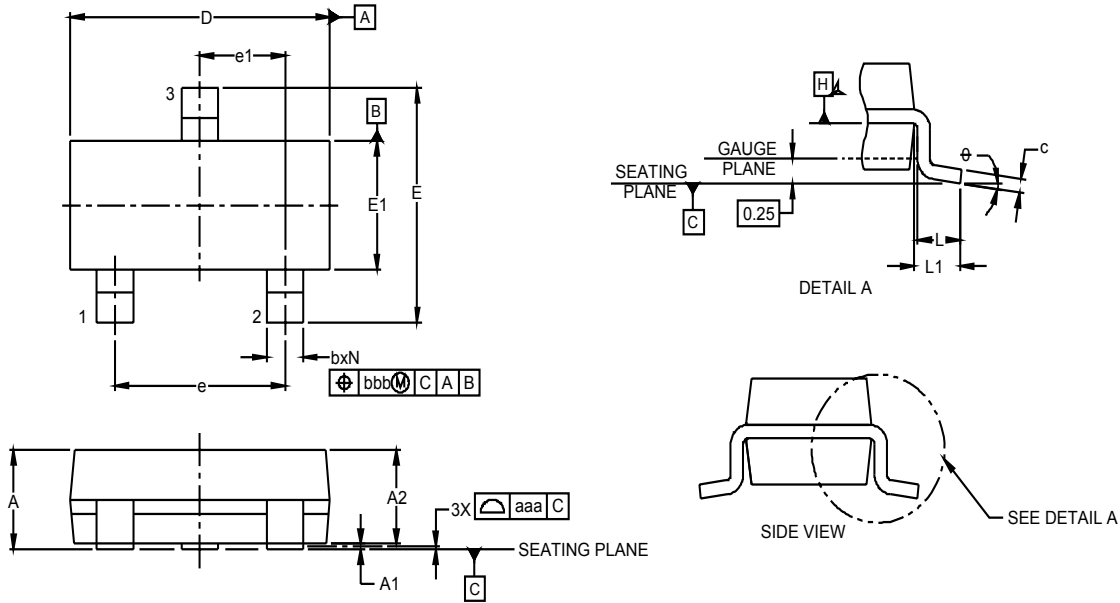

Dimensions						
DIM	Inches			Millimeters		
	Min	Nom	Max	Min	Nom	Max
A	.035	-	.044	0.89	-	1.12
A1	-	-	.004	0.01	-	0.10
A2	.035	.037	.040	0.01	-	0.10
b	.012	-	.020	0.30	-	0.51
c	.003	-	.007	0.08	-	0.18
D	.110	.114	.120	2.80	2.90	3.04
E	.082	.093	.104	2.10	2.37	2.64
E1	0.47	.051	.055	1.20	1.30	1.40
e		.075			1.90 BCS	
e1		.037			0.95 BCS	
L	.015	.020	.024	0.40	0.50	0.60
L1		.022			(0.55)	
N		3			3	

## TVS/ESD Arrays - RLST23A2.82LV Series

### Soldering footprint

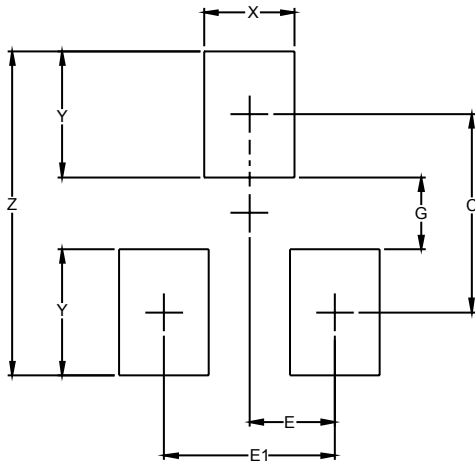

DIMENSIONS		
DIM	INCHES	MILLIMETERS
C	(.087)	(2.20)
E	.037	0.95
E1	.075	1.90
G	.031	0.80
X	.039	1.00
Y	.055	1.40
Z	.141	3.60

**NOTES:**

1. THIS LAND PATTERN IS FOR REFERENCE PURPOSES ONLY  
CONSULT YOUR MANUFACTURING GROUP TO ENSURE YOUR  
COMPANY'S MANUFACTURING GUIDELINES ARE MET.
2. REFERENCE IPC-SM-782A.

### Part Number Code

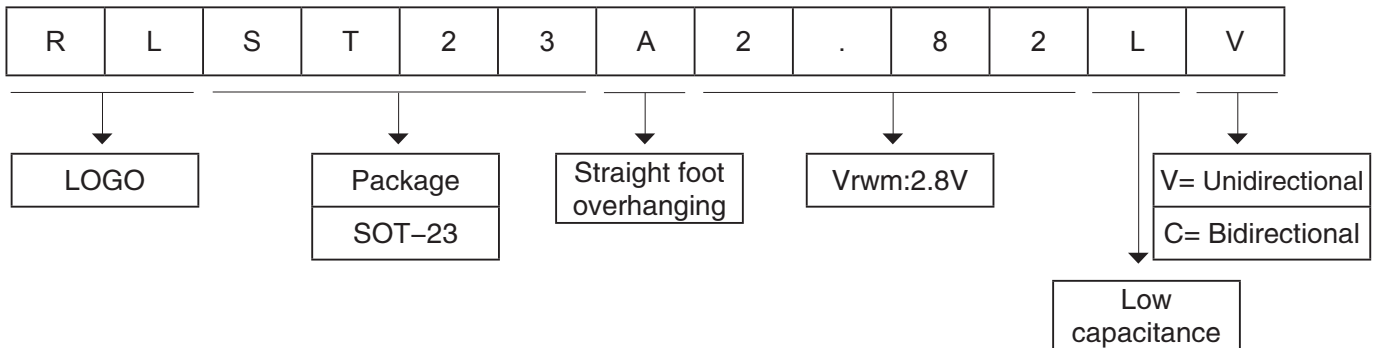

## TVS/ESD Arrays - RLST23A2.82LV Series

### Ordering Information

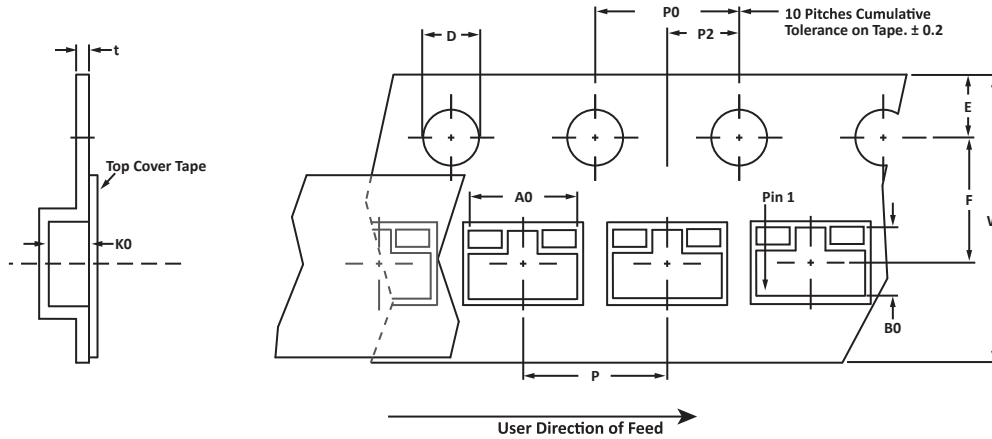

### SPECIFICATIONS

REEL DIA.	TAPE WIDTH	A0	B0	K0	D	E	F	W	P0	P2	P	tmax
178mm (7")	8mm	3.15 ± 0.10	2.77 ± 0.10	1.30 ± 0.10	1.55 ± 0.10	1.75 ± 0.10	3.50 ± 0.05	8.00 ± 0.30	4.00 ± 0.10	2.00 ± 0.05	4.00 ± 0.10	0.228

**NOTES**

1. Dimensions are in millimeters.
2. Surface mount product is taped and reeled in accordance with EIA-481.
3. Suffix - T7 = 7" Reel - 3,000 pieces per 8mm tape.
4. Suffix - T13 = 13" Reel - 10,000 pieces per 8mm tape.
5. Marking on Part - marking code (see page 2) and date code.

Package outline, pad layout and tape specifications per document number 06012.R2 8/10.

### Ordering Information

Part Number	Package	Min. Order Qty.
RLST23A2.82LV	SOT-23	3000pcs

### Warehouse Storage Conditions of Products

• Storage Conditions:

1. Storage Temperature: -10°C~+40°C
2. Relative Humidity: ≤75%RH
3. Keep away from corrosive atmosphere and sunlight.
4. Period of Storage: 1 year



## RuiLongYuan Electronics Co., Ltd.

---

- Reproducing and modifying information of the document is prohibited without permission from Ruilongyuan International Inc.
- Ruilongyuan International Inc. reserves the rights to make changes of the content herein the document anytime without notification. Please refer to our website for the latest document.
- Ruilongyuan International Inc. disclaims any and all liability arising out of the application or use of any product including damages incidentally and consequentially occurred.
- Ruilongyuan International Inc. does not assume any and all implied warranties, including warranties of fitness for particular purpose, non-infringement and merchantability.
- Applications shown on the herein document are examples of standard use and operation. Customers are responsible in comprehending the suitable use in particular applications. Ruilongyuan International Inc. makes no representation or warranty that such applications will be suitable for the specified use without further testing or modification.
- The products shown herein are not designed and authorized for equipments requiring high level of reliability or relating to human life and for any applications concerning life-saving or life-sustaining, such as medical instruments, transportation equipment, aerospace machinery et cetera. Customers using or selling these products for use in such applications do so at their own risk and agree to fully indemnify Ruilongyuan International Inc. for any damages resulting from such improper use or sale.

---

**Tel: +86-755-8290 8296**

**Fax: +86-755-8290 8002**

**E-mail: jack@ruilon.com**