

### DESCRIPTION

The NB621 is a high frequency synchronous rectified step-down switch mode converter with a built in internal high side power MOSFET and integrated LDO. It offers a very compact solution to achieve 8A continuous output current over a wide input, load and line range.

Current mode operation provides fast transient response and eases loop stabilization.

Full protection features include OCP and thermal shut down.

The NB621 requires a minimum number of readily available standard external components and is available in a space saving 4mm x 5mm 28-pin QFN package.

### FEATURES

- Wide 5.5V to 25V Operating Input Range
- 8A Output Current
- Internal Low  $R_{DS(ON)}$  Power MOSFETs
- Fixed 600kHz switching frequency
- Sync from 300kHz to 2MHz External Clock
- Integrated 100mA LDO
- Internal Compensation
- Power Good Output
- Integrated Bootstrap Diode
- OCP Protection and Thermal Shutdown
- Output Adjustable from 0.8V to 15V
- Available in 4mm x 5mm 28-pin QFN package.

### APPLICATIONS

- Notebook Systems and I/O Power
- Networking Systems
- Digital Set Top Boxes
- Personal Video Recorders
- Flat Panel Television and Monitors
- Distributed Power Systems

"MPS" and "The Future of Analog IC Technology" are Registered Trademarks of Monolithic Power Systems, Inc.

### TYPICAL APPLICATION (FOR NOTEBOOK)

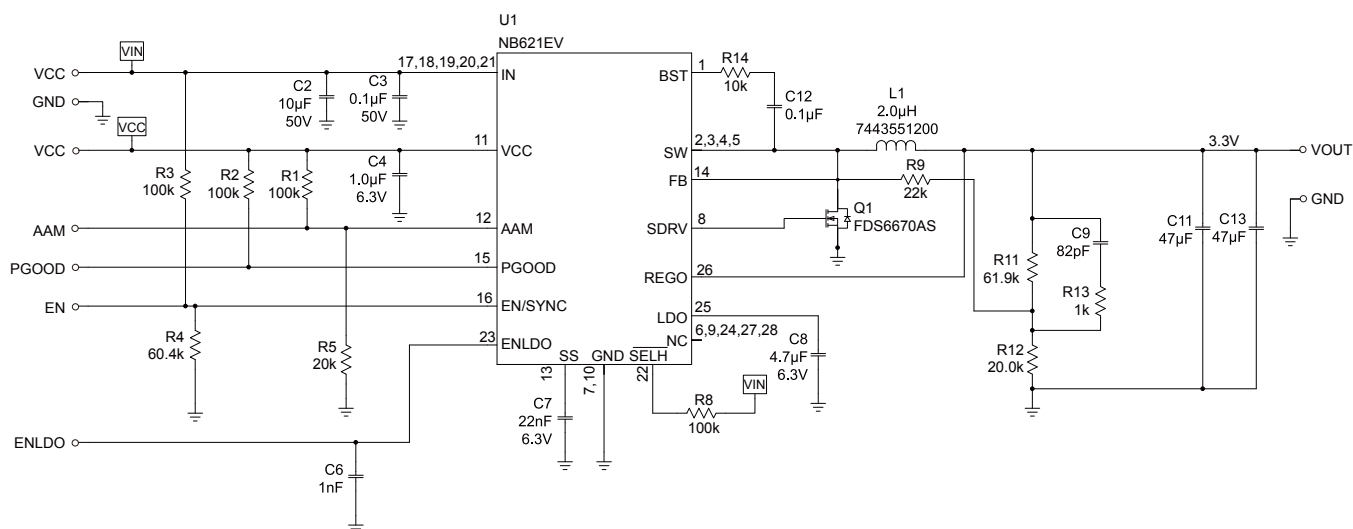

## ORDERING INFORMATION

Part Number*	Package	Top Marking	Free Air Temperature (T <sub>A</sub> )
NB621EV	QFN28 (4mmx5mm)	N621EV	-20°C to +85°C

\* For Tape & Reel, add suffix -Z (e.g. NB621EV-Z);  
For RoHS compliant packaging, add suffix -LF (e.g. NB621EV-LF-Z).

## PACKAGE REFERENCE

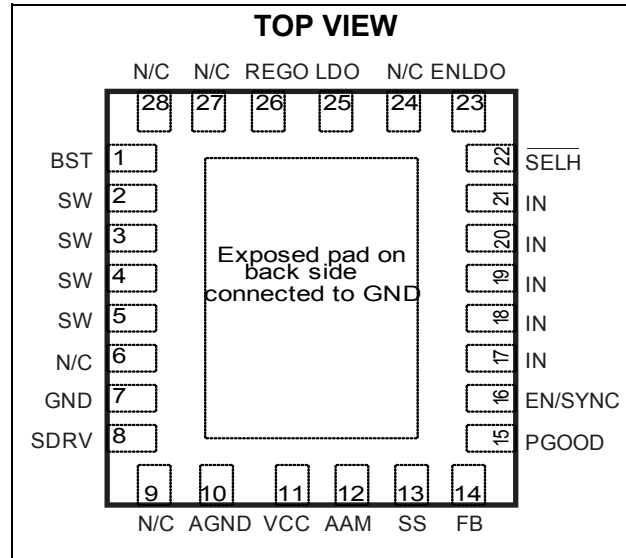

### ABSOLUTE MAXIMUM RATINGS <sup>(1)</sup>

Supply Voltage V <sub>IN</sub> .....	28V
V <sub>SW</sub> .....	-0.3V to V <sub>IN</sub> + 0.3V
V <sub>BS</sub> .....	V <sub>SW</sub> + 6V
I <sub>VIN(RMS)</sub> .....	3A
I <sub>SW(RMS)</sub> .....	3A
All Other Pins.....	-0.3V to +6V
Continuous Power Dissipation (T <sub>A</sub> =+25°C) <sup>(2)</sup>	3.1W
Junction Temperature.....	150°C
Lead Temperature.....	260°C
Storage Temperature.....	-65°C to +150°C

### Recommended Operating Conditions <sup>(3)</sup>

Supply Voltage V <sub>IN</sub> .....	5.5V to 25V
Output Voltage V <sub>OUT</sub> .....	0.8V to 15V
Operating Junct. Temp (T <sub>J</sub> ).....	-20°C to +125°C

<b>Thermal Resistance <sup>(4)</sup></b>	<b>θ<sub>JA</sub></b>	<b>θ<sub>JC</sub></b>	
4x5 QFN28.....	40.....	9	°C/W

#### Notes:

- Exceeding these ratings may damage the device.
- The maximum allowable power dissipation is a function of the maximum junction temperature T<sub>J(MAX)</sub>, the junction-to-ambient thermal resistance θ<sub>JA</sub>, and the ambient temperature T<sub>A</sub>. The maximum allowable continuous power dissipation at any ambient temperature is calculated by P<sub>D(MAX)</sub>=(T<sub>J(MAX)</sub>-T<sub>A</sub>)/ θ<sub>JA</sub>. Exceeding the maximum allowable power dissipation will cause excessive die temperature, and the regulator will go into thermal shutdown. Internal thermal shutdown circuitry protects the device from permanent damage.
- The device is not guaranteed to function outside of its operating conditions.
- Measured on JESD51-7, 4-layer PCB.

## ELECTRICAL CHARACTERISTICS

$V_{IN} = 12V$ ,  $T_A = +25^{\circ}C$ , unless otherwise noted.

Parameters	Symbol	Condition	Min	Typ	Max	Units
Supply Current (Shutdown)	$I_{IN}$	$V_{ENLDO} = 0V$		30	TBD	$\mu A$
Supply Current (Quiescent)	$I_{IN}$	$V_{EN} = 2V$ , $V_{FB} = 1V$		1.3	TBD	mA
High Side Switch On Resistance <sup>(5)</sup>	$HSW_{RDS-ON}$			50		m $\Omega$
Switch Leakage	$SW_{LKG}$	$V_{EN} = 0V$ , $V_{SW} = 0V$		0	10	$\mu A$
Current Limit <sup>(5)</sup>	$I_{LIMIT}$		9.5			A
Oscillator Frequency	$F_{SW}$	$V_{FB} = 0.75V$		600		kHz
Fold-back Frequency	$F_{FB}$	$V_{FB} = 100mV$		0.25		f <sub>SW</sub>
Maximum Duty Cycle	$D_{MAX}$	$V_{FB} = 700mV$	85	90		%
Sync Frequency Range	$F_{SYNC}$		0.3		2	MHz
Feedback Voltage	$V_{FB}$		788	808	828	mV
Feedback Current	$I_{FB}$	$V_{FB} = 800mV$		10	50	nA
Soft Start Charging Current	$I_{SS}$	$V_{SS}=0V$		10		$\mu A$
EN/SYNC Input Low Voltage	$V_{ILEN}$				0.4	V
EN/SYNC Input High Voltage	$V_{IHEN}$		2			V
EN Input Current	$I_{EN}$	$V_{EN} = 2V$ $V_{EN} = 0V$		2 0		$\mu A$
EN Turn Off Delay	$EN_{Td-Off}$			5		$\mu sec$
Power Good Threshold Rising	$PG_{Vth-Hi}$			0.9		$V_{FB}$
Power Good Threshold Falling	$PG_{Vth-Lo}$			0.7		$V_{FB}$
Power Good Delay <sup>(5)</sup>	$PG_{Td}$			0.42		$T_{SS}$ <sup>(6)</sup>
Power Good Sink Current Capability	$V_{PG}$	Sink 4mA			0.4	V
Power Good Leakage Current	$I_{PG\_LEAK}$	$V_{PG} = 3.3V$			10	nA
VIN Under Voltage Lockout Threshold Rising	$INUV_{Vth}$	$V_{ENLDO}=open$		5.06		V
VIN Under Voltage Lockout Threshold Hysteresis	$INUV_{HYS}$	$V_{ENLDO}=open$		450		mV
VCC Under Voltage Lockout Threshold Rising	$VCCUV_{Vth}$	$V_{ENLDO}=open$	3.8	4.0	4.2	V
VCC Under Voltage Lockout Threshold Hysteresis	$VCCUV_{HYS}$	$V_{ENLDO}=open$		880		mV
VCC Regulator	$V_{CC}$		4.5	5		V
VCC Load Regulation		$I_{CC}=20mA$		5		%

**ELECTRICAL CHARACTERISTICS** *(continued)*
 $V_{IN} = 12V$ ,  $T_A = +25^{\circ}C$ , unless otherwise noted.

Parameters	Symbol	Condition	Min	Typ	Max	Units
LDD Switch On Resistance <sup>(5)</sup>	$R_{LDO}$	$V_{LDO}=5V$ , $I_{LDO}=100mA$		5		$\Omega$
LDO Output Voltage	$V_{LDO}$	$SELH=0V$ , $I_{LDO}<100mA$	4.8	5	5.2	V
		$SELH=0V$ , $I_{LDO}<100mA$ , $6.5V<V_{IN}<25V$	4.75	5	5.25	V
		$V_{LDO}=0V$ , $I_{LDO}<50mA$ , $5.5V<V_{IN}<25V$	4.75	5	5.25	V
		$SELH=5V$ , $I_{LDO}<100mA$	3.2	3.33	3.46	V
		$SELH=5V$ , $I_{LDO}<100mA$ , $6.5V<V_{IN}<25V$	3.13	3.33	3.5	V
		$SELH=5V$ , $I_{LDO}<50mA$ , $5.5V<V_{IN}<25V$	3.13	3.33	3.5	V
LDO Output Current	$I_{LDO}$	$SELH=0V$	100			mA
		$SELH=5V$	100			mA
Switch Over Threshold (Rising)	$V_{SWO}$	$SELH=0V$	4.55	4.7	4.85	V
		$SELH=5V$	3.05	3.15	3.25	V
Switch Over Hysteresis	$V_{SWO-HYS}$	$SELH=0V$	0.15	0.25	0.3	V
		$SELH=5V$	0.1	0.2	0.25	V
SELH Input Low Voltage	$V_{IL-SELH}$			0.4	V	
SELH Input High Voltage	$V_{IH-SELH}$		2.5		V	
ENLDO Input Low Voltage $V_{IL-ENLDO}$				0.4	V	
ENLDO Input High Voltage $V_{IH-ENLDO}$			2		V	
Thermal Shutdown	$T_{SD}$			150		$^{\circ}C$

**Note:**

- 5) Guaranteed by design.  
6) TSS—Soft startup time

## TYPICAL PERFORMANCE CHARACTERISTICS

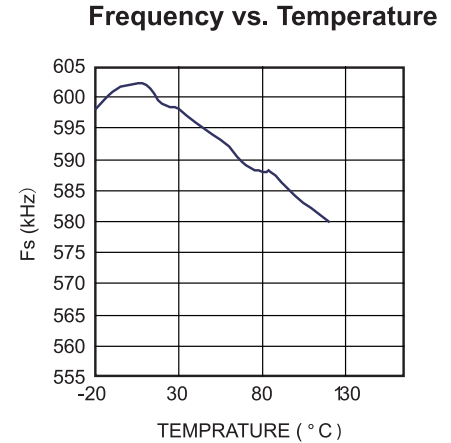
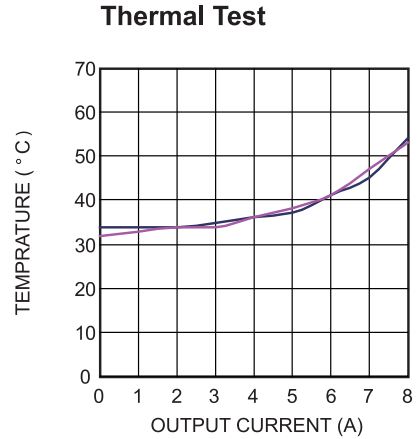
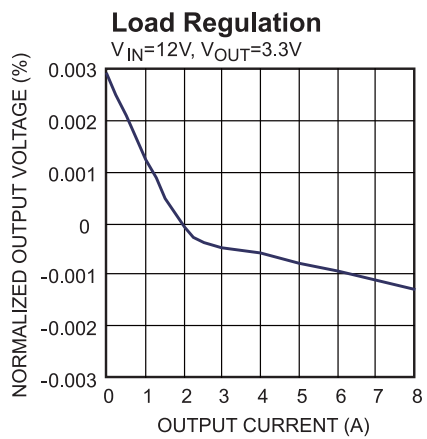
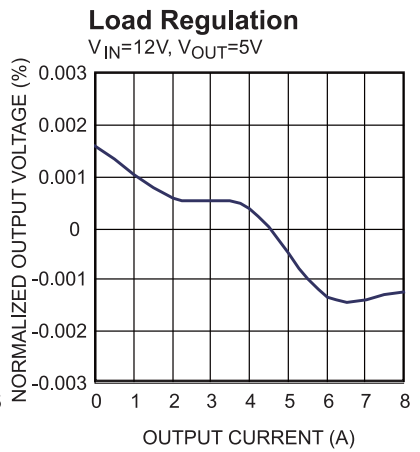
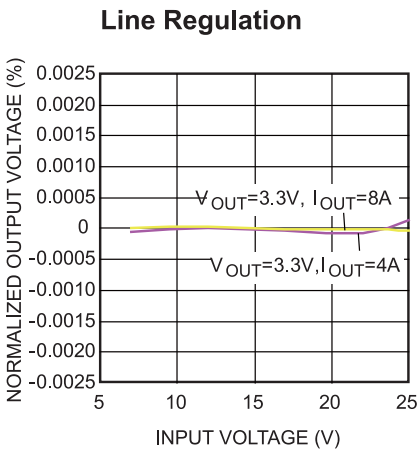
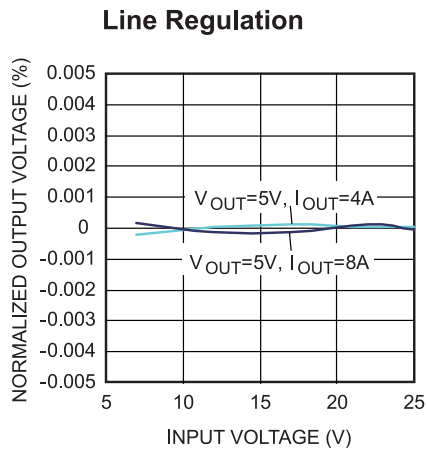
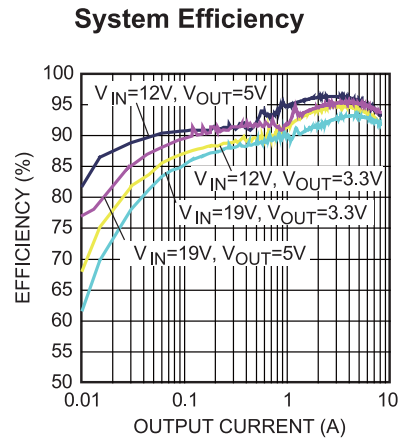
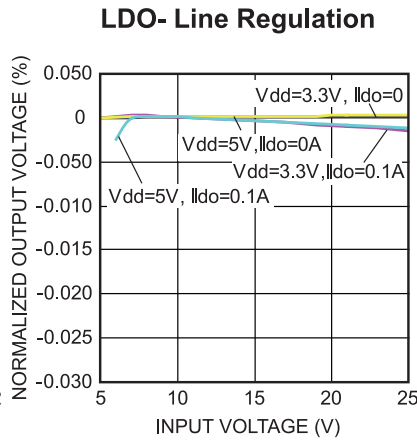
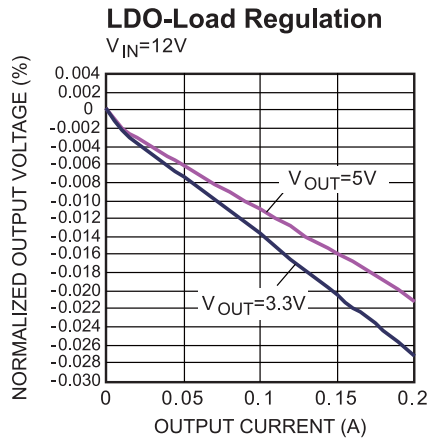

**TYPICAL PERFORMANCE CHARACTERISTICS (continued)**

**V<sub>BST</sub> vs. I<sub>OUT</sub>  
for V<sub>IN</sub>=12V & 19V**

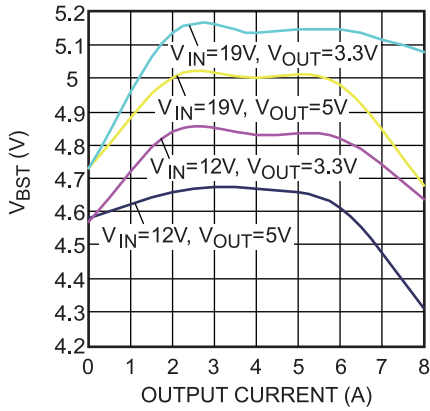

**V<sub>BST</sub> vs. I<sub>OUT</sub>  
for 0.1uF & 1uF**

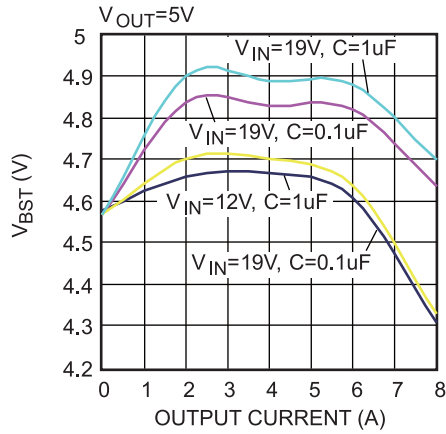

**V<sub>BST</sub> vs. Temperature**

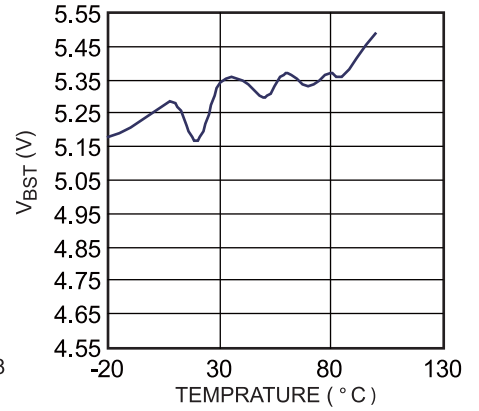

**TYPICAL PERFORMANCE CHARACTERISTICS (continued)**

**LDO-Transient Response**

$V_{IN} = 12V$ ,  $EN = GND$ ,  $V_{IDO} = 5V$ ,  
 $I_{IDO} = 10mA @ 250mA/\mu s$

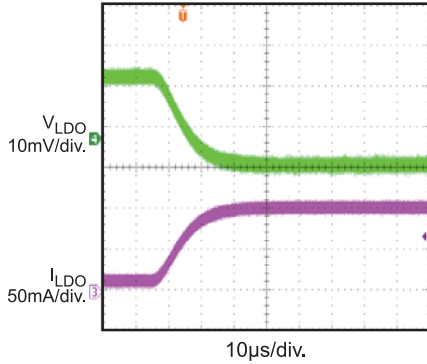

**LDO-Transient Response**

$V_{IN} = 12V$ ,  $EN = GND$ ,  $V_{IDO} = 5V$ ,  
 $I_{IDO} = 100mA @ 250mA/\mu s$

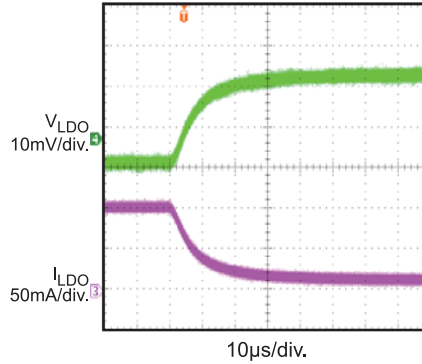

**LDO Startup**

$V_{IN} = 12V$ ,  $V_{OUT.IDO} = 5V$

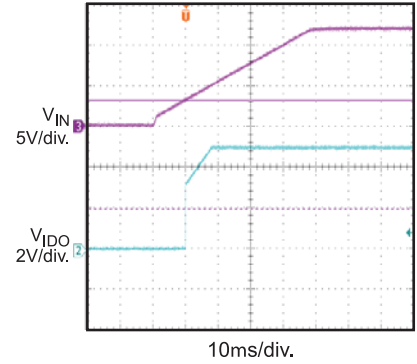

**LDO-EN Startup**

$V_{IN} = 12V$ ,  $V_{IDO} = 5V$ ,  $I_{IDO} = 0.1A$

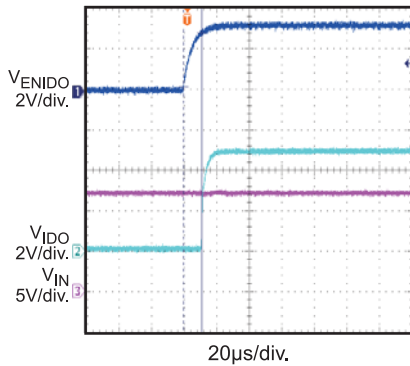

**Switcher Output Voltage Ripple – No Current Load**

$V_{IN} = 12V$ ,  $V_O = 5V$ ,  $I_O = 0V$   
AAM Voltage=0.65V

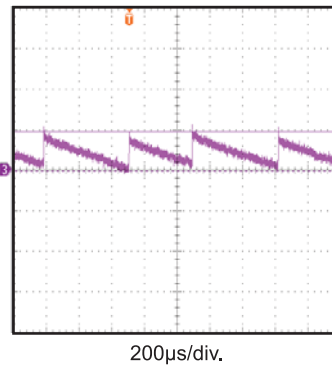

**Switcher Output Voltage Ripple – Full Current Load**

$V_{IN} = 12V$ ,  $V_O = 5V$ ,  $I_O = 8A$   
AAM Voltage=0.65V

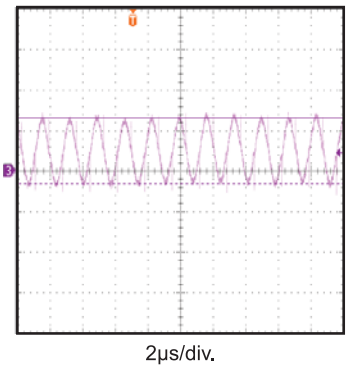

**Transient Response**

$V_{IN} = 12V$ ,  $V_O = 5V$ ,  
 $I_O$  from 0.5A to 7A @ 2.5A/ $\mu s$   
Add 330 $\mu F$  Poscon cap to  $C_{out}$ .

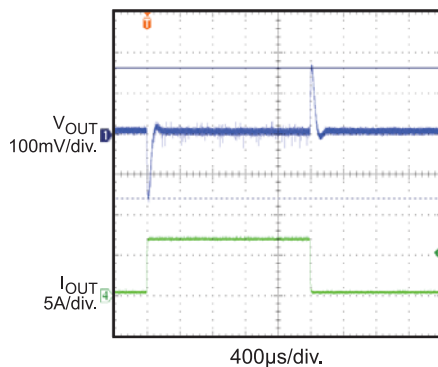

**Transient Response**

$V_{IN} = 12V$ ,  $V_O = 3.3V$ ,  
 $I_O$  from 0.5A to 7A @ 2.5A/ $\mu s$   
Add 330 $\mu F$  Poscon cap.

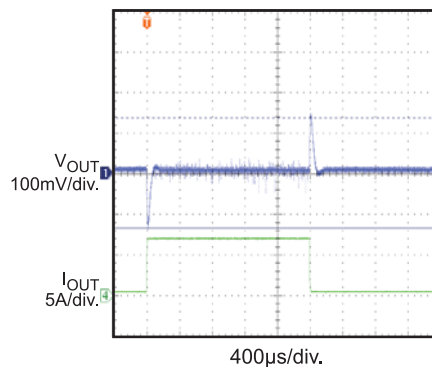

**Power Startup – No Load**

$V_{IN} = 12V$ ,  $V_O = 3.3V$ ,  $I_O = 0A$

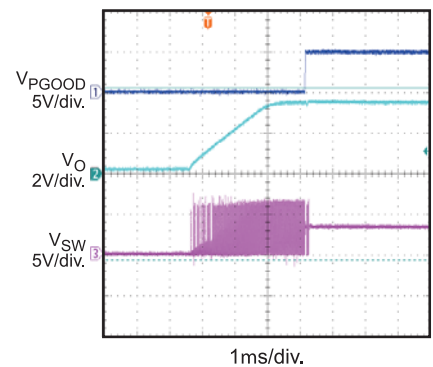

**TYPICAL PERFORMANCE CHARACTERISTICS (continued)**

**Power Startup – No Load**

$V_{IN} = 12V, V_O = 5V, I_O = 0A$

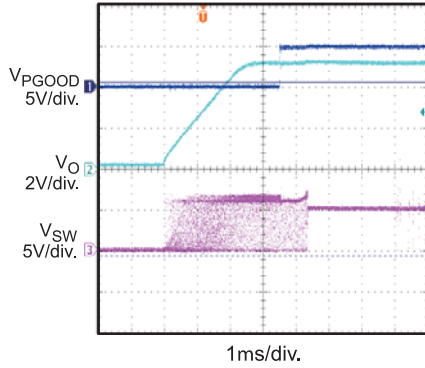

**Power Startup – Full Load**

$V_{IN} = 12V, V_O = 3.3V, I_O = 8A$

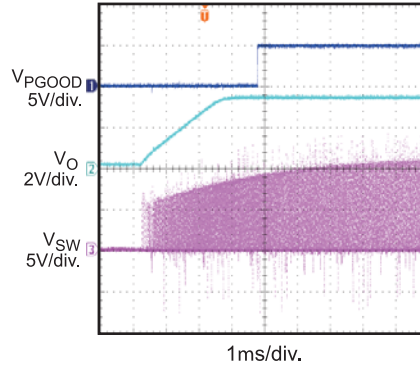

**Power Startup – Full Load**

$V_{IN} = 12V, V_O = 5V, I_O = 8A$

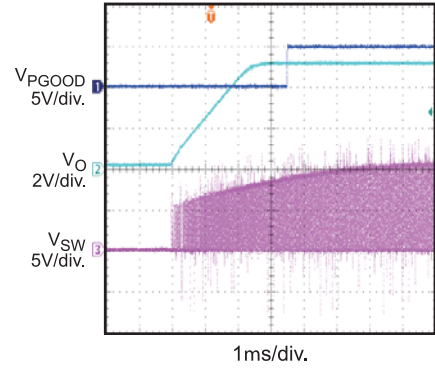

**Power On with Shorted Vout**

$V_{IN} = 12V, V_O = 5V, I_O = 8A$

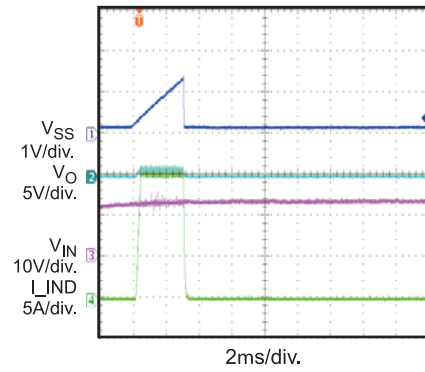

**EN Startup with I<sub>o</sub>=7A**

$V_{IN} = 12V, V_O = 5V$

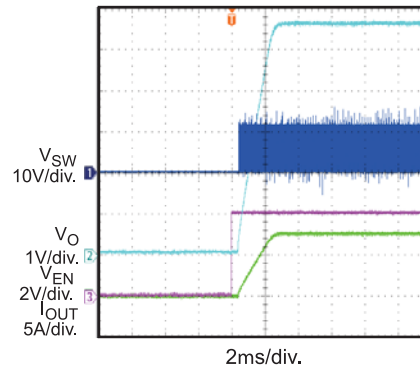

**SCP Entry**

$V_{IN} = 12V, V_O = 5V, R_L = 7\Omega$

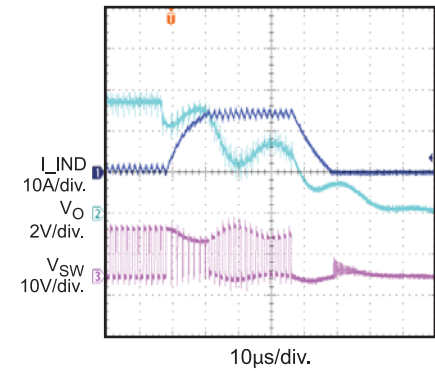



## PIN FUNCTIONS

Pin #	Name	Description
1	BST	Bootstrap. A capacitor connected between SW and BS pins is required to form a floating supply across the high-side switch driver.
2, 3, 4, 5	SW	Switch Output. Use wide PCB traces and multiple vias to make the connection.
6, 9, 24, 27, 28	N/C	No Connection.
7	GND	System Ground. This pin is the reference ground of the regulated output voltage. For this reason care must be taken in PCB layout.
8	SDRV	Low Side Gate Driver Output.
10	AGND	Analog Ground.
11	VCC	Bias Supply. Decouple with 1 $\mu$ F capacitor.
12	AAM	Connect to GND forces NB621 in synchronous mode. Connects to a voltage set by 2 resistor dividers forces NB621 into non-synchronous mode when load is small.
13	SS	Soft Start. Connect on external capacitor to program the soft start time for the switch mode regulator.
14	FB	Feedback. An external resistor divider from the output to GND, tapped to the FB pin, sets the output voltage. To prevent current limit run away during a short circuit fault condition the frequency fold-back comparator lowers the oscillator frequency when the FB voltage is below 400mV.
15	PG	Power good output, the output of this pin is an open drain and is high if the output voltage is higher than 90% of the nominal voltage. There is a 20 $\mu$ s delay to pull PG if the output voltage is lower than 10% of regulation value.
16	EN/SYNC	EN=1 to enable the NB621. External clock can be applied to EN pin for changing switching frequency. For automatic start-up, connect EN pin to VIN with 100K $\Omega$ resistor.
17,18,19,20,21	IN	Supply Voltage. The NB621 operates from a +4.5V to +25V input rail. C1 is needed to decouple the input rail. Use wide PCB traces and multiple vias to make the connection.
22	SELH	Internal LDO output voltage selection. When grounded, the LDO output will be regulated to 5V. When pulled high, the LDO output will be regulated to 3.3V.
23	ENLDO	Internal LDO regulator enable pin
25	LDO	Internal LDO regulator Output. Connect a 10uF decoupling capacitor to GND.
26	REGO	Switch Mode Regulator Output connection pin. This pin is used to switch the internal LDO output to the switch mode regulator output when it is available.



regulator is in full regulation. When VIN is lower than 5.0 V, the output of the regulator decreases. Since this internal regulator provides the bias current for the bottom gate driver that requires significant amount of current depending upon the external MOSFET selection, a 1 μF ceramic capacitor for decoupling purpose is required.

**Enable/Sync Control**

The NB621 has a dedicated Enable/Sync control pin (EN/SYNC). By pulling it high or low, the IC can be enabled and disabled by EN. Tie EN to VIN for automatic start up. To disable the part, EN must be pulled low for at least 5μs.

The NB621 can be synchronized to external clock range from 300 kHz up to 2 MHz through the EN/SYNC pin. The internal clock rising edge is synchronized to the external clock rising edge.

**Under-Voltage Lockout (UVLO)**

Under-voltage lockout (UVLO) is implemented to protect the chip from operating at insufficient supply voltage. The NB621 UVLO comparator monitors the output voltage of the internal regulator, VCC. The UVLO rising threshold is about 4.0 V while its falling threshold is a consistent 3.2 V.

**Soft-Start**

The soft-start is implemented to prevent the converter output voltage from overshooting during startup. When the chip starts, the internal circuitry generates a soft-start voltage (SS) ramping up from 0 V to 1.2 V. When it is lower than the internal reference (REF), SS overrides REF so the error amplifier uses SS as the reference. When SS is higher than REF, REF regains control. The soft start time ( $T_{ss}$ ) can be calculated by:

$$T_{ss} = \frac{1.2 \cdot C_{ss}}{10 \cdot 10^{-6}}$$

**Over-Current-Protection and Hiccup**

The NB621 has cycle-by-cycle over current limit when the inductor current peak value exceeds the set current limit threshold. Meanwhile, output voltage starts to drop until FB is below the Under-Voltage (UV) threshold, typically 30% below the reference. Once a UV is triggered, the NB621 enters hiccup mode to periodically restart the part. This protection mode is especially useful when the output is dead-short to ground. The average

short circuit current is greatly reduced to alleviate the thermal issue and to protect the regulator. The NB621 exits the hiccup mode once the over current condition is removed.

**Thermal Shutdown**

Thermal shutdown is implemented to prevent the chip from operating at exceedingly high temperatures. When the silicon die temperature is higher than 150°C, it shuts down the whole chip. When the temperature is lower than its lower threshold, typically 140°C, the chip is enabled again.

**Floating Driver and Bootstrap Charging**

The floating power MOSFET driver is powered by an external bootstrap capacitor. This floating driver has its own UVLO protection. This UVLO’s rising threshold is 2.2 V with a hysteresis of 150mV. The bootstrap capacitor voltage is regulated internally by VIN through D1, M3, C4, L1 and C2 (Figure 2). If (VIN-VSW) is more than 5 V, U2 will regulate M3 to maintain a 5V BST voltage across C4.

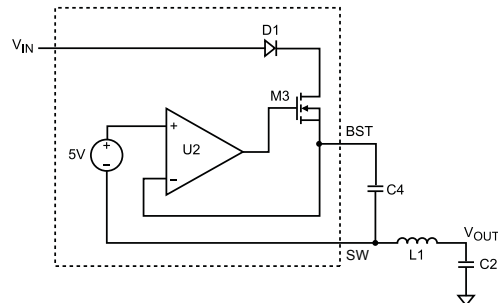

**Figure 2—Internal Bootstrap Charging Circuit**

**Startup and Shutdown**

If both VIN and EN are higher than their appropriate thresholds, the chip starts. The reference block starts first, generating stable reference voltage and currents, and then the internal regulator is enabled. The regulator provides stable supply for the remaining circuitries.

Three events can shut down the chip: EN low, VIN low and thermal shutdown. In the shutdown procedure, the signaling path is first blocked to avoid any fault triggering. The COMP voltage and the internal supply rail are then pulled down. The floating driver is not subject to this shutdown command.

## APPLICATION INFORMATION

### Setting the Output Voltage

The external resistor divider is used to set the output voltage (see the schematic on front page). The feedback resistor R1 also sets the feedback loop bandwidth with the internal compensation capacitor (see Figure 1). Choose R1 to be around 31.6kΩ for optimal transient response. R2 is then given by:

$$R2 = \frac{R1}{\frac{V_{OUT}}{0.8V} - 1}$$

**Table 1—Resistor Selection for Common Output Voltages**

V <sub>OUT</sub> (V)	R1 (kΩ)	R2 (kΩ)
1.8	31.6 (1%)	25.5 (1%)
2.5	31.6 (1%)	14.7(1%)
3.3	31.6 (1%)	10(1%)
5	31.6 (1%)	6.04 (1%)

### Selecting the Inductor

A 1μH to 10μH inductor with a DC current rating of at least 25% percent higher than the maximum load current is recommended for most applications. For highest efficiency, the inductor DC resistance should be less than 15mΩ. For most designs, the inductance value can be derived from the following equation.

$$L = \frac{V_{OUT} \times (V_{IN} - V_{OUT})}{V_{IN} \times \Delta I_L \times f_{OSC}}$$

Where ΔI<sub>L</sub> is the inductor ripple current.

Choose inductor current to be approximately 30% if the maximum load current, 8A. The maximum inductor peak current is:

$$I_{L(MAX)} = I_{LOAD} + \frac{\Delta I_L}{2}$$

Under light load conditions below 100mA, larger inductance is recommended for improved efficiency.

### Selecting the Input Capacitor

The input current to the step-down converter is discontinuous, therefore a capacitor is required to supply the AC current to the step-down converter while maintaining the DC input voltage. Use low ESR capacitors for the best performance. Ceramic capacitors with X5R or X7R dielectrics are highly recommended because of their low ESR and small temperature coefficients. For most applications, a 22μF capacitor is sufficient.

Since the input capacitor (C1) absorbs the input switching current it requires an adequate ripple current rating. The RMS current in the input capacitor can be estimated by:

$$I_{C1} = I_{LOAD} \times \sqrt{\frac{V_{OUT}}{V_{IN}} \times \left(1 - \frac{V_{OUT}}{V_{IN}}\right)}$$

The worse case condition occurs at V<sub>IN</sub> = 2V<sub>OUT</sub>, where:

$$I_{C1} = \frac{I_{LOAD}}{2}$$

For simplification, choose the input capacitor whose RMS current rating greater than half of the maximum load current.

The input capacitor can be electrolytic, tantalum or ceramic. When using electrolytic or tantalum capacitors, a small, high quality ceramic capacitor, i.e. 0.1μF, should be placed as close to the IC as possible. When using ceramic capacitors, make sure that they have enough capacitance to provide sufficient charge to prevent excessive voltage ripple at input. The input voltage ripple caused by capacitance can be estimated by:

$$\Delta V_{IN} = \frac{I_{LOAD}}{f_s \times C1} \times \frac{V_{OUT}}{V_{IN}} \times \left(1 - \frac{V_{OUT}}{V_{IN}}\right)$$

**Selecting the Output Capacitor**

The output capacitor (C2) is required to maintain the DC output voltage. Ceramic, tantalum, or low ESR electrolytic capacitors are recommended. Low ESR capacitors are preferred to keep the output voltage ripple low. The output voltage ripple can be estimated by:

$$\Delta V_{OUT} = \frac{V_{OUT}}{f_s \times L} \times \left(1 - \frac{V_{OUT}}{V_{IN}}\right) \times \left(R_{ESR} + \frac{1}{8 \times f_s \times C2}\right)$$

Where L is the inductor value and RESR is the equivalent series resistance (ESR) value of the output capacitor.

In the case of ceramic capacitors, the impedance at the switching frequency is dominated by the capacitance. The output voltage ripple is mainly caused by the capacitance. For simplification, the output voltage ripple can be estimated by:

$$\Delta V_{OUT} = \frac{V_{OUT}}{8 \times f_s^2 \times L \times C2} \times \left(1 - \frac{V_{OUT}}{V_{IN}}\right)$$

In the case of tantalum or electrolytic capacitors, the ESR dominates the impedance at the switching frequency. For simplification, the output ripple can be approximated to:

$$\Delta V_{OUT} = \frac{V_{OUT}}{f_s \times L} \times \left(1 - \frac{V_{OUT}}{V_{IN}}\right) \times R_{ESR}$$

The characteristics of the output capacitor also affect the stability of the regulation system. The NB621 can be optimized for a wide range of capacitance and ESR values.

**PC Board Layout**

The high current paths (GND, IN and SW) should be placed very close to the device with short, direct and wide traces. The input capacitor needs to be as close as possible to the IN and GND pins. The external feedback resistors should be placed next to the FB pin. Keep the switching node SW short and away from the feedback network.

**External Bootstrap Diode**

An external bootstrap diode may enhance the efficiency of the regulator, the applicable conditions of external BST diode are:

- V<sub>OUT</sub> is 5V or 3.3V; and
- Duty cycle is high:  $D = \frac{V_{OUT}}{V_{IN}} > 65\%$

In these cases, an external BST diode is recommended from the output of the voltage regulator to BST pin, as shown in Figure 3.

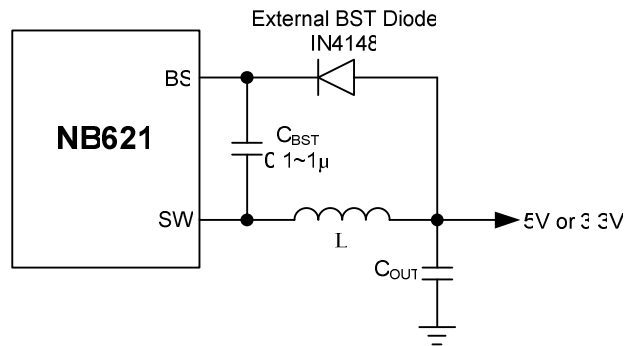
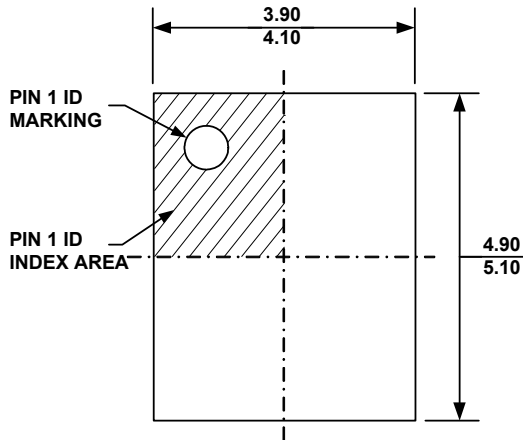

**Figure 3—Add Optional External Bootstrap Diode to Enhance Efficiency**

The recommended external BST diode is IN4148, and the BST cap is 0.1~1µF.

**PACKAGE INFORMATION**

**4mm x 5mm QFN28**



**TOP VIEW**

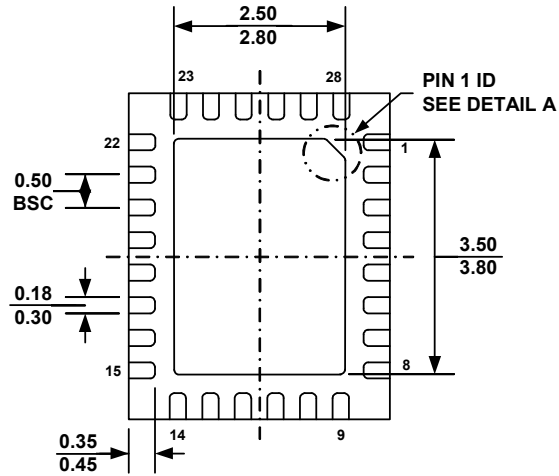

**BOTTOM VIEW**

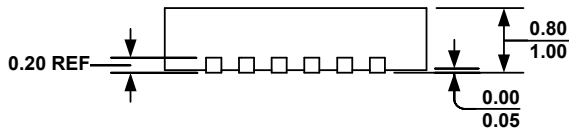

**SIDE VIEW**

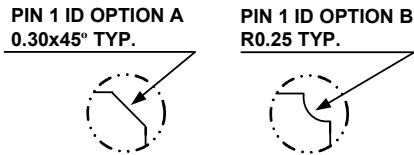

**DETAIL A**

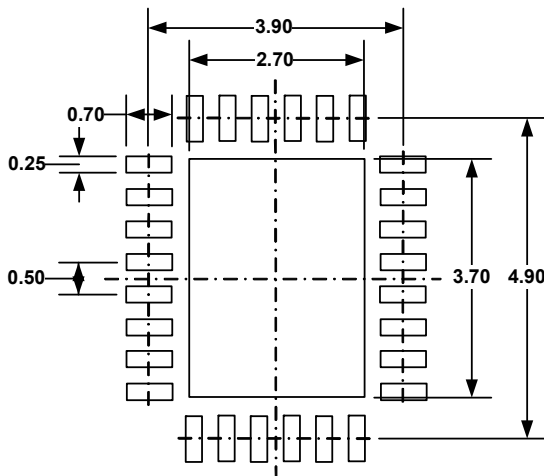

**RECOMMENDED LAND PATTERN**

**NOTE:**

- 1) ALL DIMENSIONS ARE IN MILLIMETERS.
- 2) EXPOSED PADDLE SIZE DOES NOT INCLUDE MOLD FLASH.
- 3) LEAD COPLANARITY SHALL BE 0.10 MILLIMETER MAX.
- 4) DRAWING CONFORMS TO JEDEC MO-220, VARIATION VHGD-3.
- 5) DRAWING IS NOT TO SCALE.

**NOTICE:** The information in this document is subject to change without notice. Users should warrant and guarantee that third party Intellectual Property rights are not infringed upon when integrating MPS products into any application. MPS will not assume any legal responsibility for any said applications.