

Getting started with ST25DV-DISCOVERY

Introduction

The ST25DV-DISCOVERY is a demonstration kit that evaluates features and capabilities of the ST25DV04K Dynamic NFC / RFID Tag.

The kit is composed of two boards:

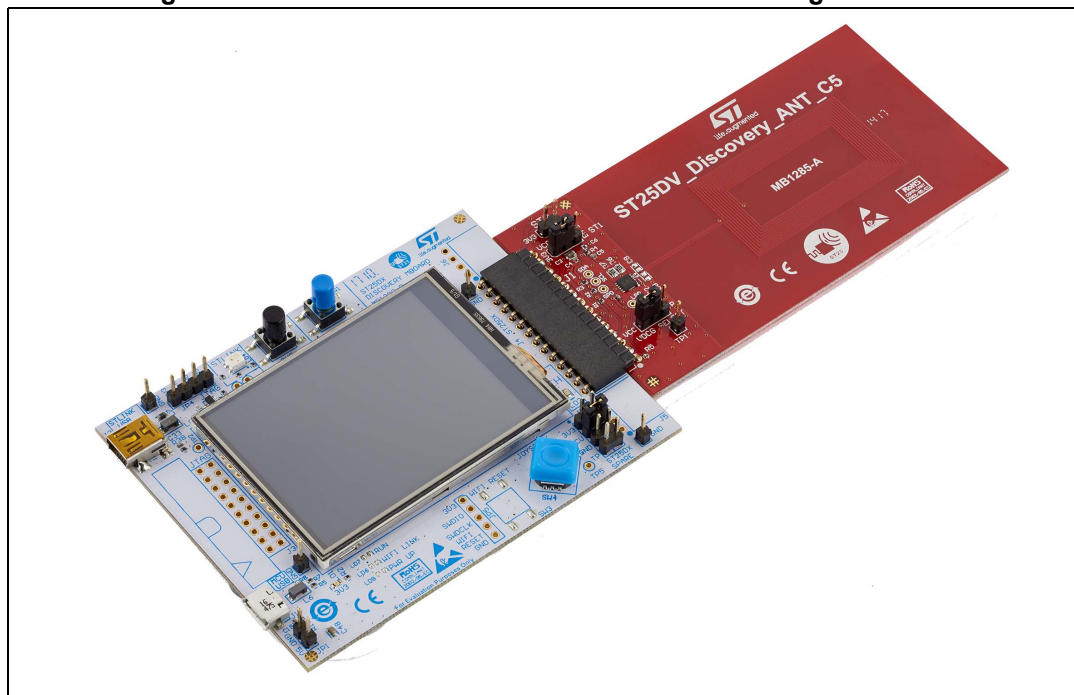
- MB1283 (ST25DX_Discovery_Mboard): a microprocessor mother board, which includes a complement of hardware and software tools allowing the use of the full STM32 Nucleo ecosystem. The board is powered through one USB connector.
- MB1285 (ST25DV_Discovery_ANT_C5): a daughter board, which embeds the ST25DV04K Dynamic NFC / RFID tag device. This daughter board provides a buffering data transfer capability and has a Class 5 antenna.

The communication link between boards is the I2C serial and the power is provided by the processor card or via energy harvesting. Specific data lines complete the pin connector assignment shared between cards.

A variety of demonstrations can be performed with this kit. The kit allows the users to develop and to test their own applications.

The MB1283 and the MB1285 boards schematics, BOM, gerber files, drivers and firmware are available at the STMicroelectronics website at www.st.com.

Figure 1. ST25DV-DISCOVERY mother board and daughter board



Contents

1	Description	4
2	Features	5
2.1	MB1283 board features	5
2.2	MB1285 board features	5
3	Hardware layout	6
3.1	MB1283 board layout	6
3.2	MB1285 board layout	7
4	ST25DV-DISCOVERY kit powering and startup	8
5	Program and debug the ST25DV-DISCOVERY kit	9
6	Hardware implementation	10
6.1	MB1283 board schematics	10
6.2	MB1285 board schematics	20
7	Revision history	21

List of figures

Figure 1.	ST25DV-DISCOVERY mother board and daughter board	1
Figure 2.	ST25DV-DISCOVERY overview	4
Figure 3.	MB1283 board top view	6
Figure 4.	MB1283 board bottom view	6
Figure 5.	MB1285 board top view	7
Figure 6.	MB1285 board bottom view	7
Figure 7.	MB1283 schematics - top level	11
Figure 8.	MB1283 schematics - power supply	12
Figure 9.	MB1283 schematics - STM32F405	13
Figure 10.	MB1283 schematics - EH	14
Figure 11.	MB1283 schematics - ST-LINK JTAG	15
Figure 12.	MB1283 schematics - LCD	16
Figure 13.	MB1283 schematics - WiFi® BLE	17
Figure 14.	MB1283 schematics - ST25DX connectors	18
Figure 15.	MB1283 schematics - USB	19
Figure 16.	MB1285 board schematics	20

1 Description

The ST25DV series Dynamic NFC tags discovery kit (ST25DV-DISCOVERY) allows the user to evaluate the features and capabilities of the ST25DV04K products.

The ST25DV-DISCOVERY kits comes with application notes, software applications, drivers, BOM (bill of materials), board schematics, gerber files and firmware schematics. All these documents help the user to reduce the design efforts and they can be downloaded at www.st.com.

The MB1283 in standard edition is designed to help the user explore the features of the ST25DV04K products with the support of the STM32 Nucleo ecosystem. This mother board uses a 32-bit ARM[®] Cortex[™]-M4 CPU with FPU high-performance microcontroller to develop the applications.

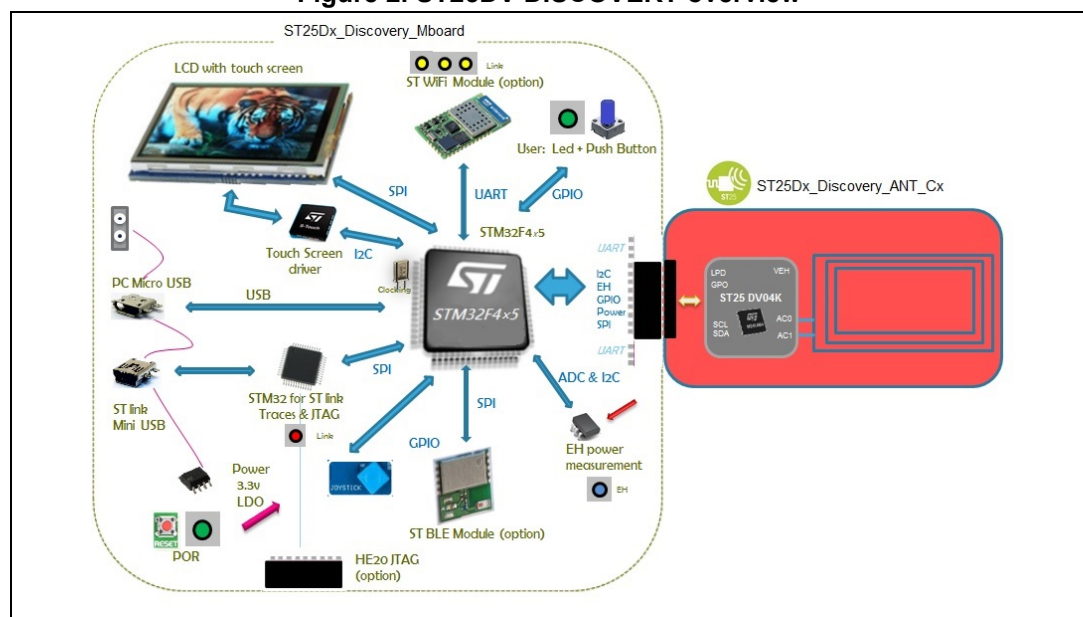
The MB1283 standard edition board is powered through the USB bus. It is based on an STM32F405 line microcontroller and includes:

- An ST-LINK embedded debug tool interface
- A 2.4" TFT LCD with touch screen capability
- LEDs
- Push buttons (reset and user)
- A mini USB debug connector
- A user-dedicated micro USB connector.

The MB1283 demonstration edition board includes all of the features of the standard edition plus a HE20 JTAG connector, a WiFi[®] module and a low-energy Bluetooth[®] module. These additional features demonstrate various use cases.

The MB1285 is a dynamic NFC/RFID tag providing a buffering data transfer capability expansion board usable with the MB1283 mother board. This daughter board interfaces with the STM32 MCU via the I2C.

Figure 2. ST25DV-DISCOVERY overview



2 Features

2.1 MB1283 board features

The MB1283 (ST25DX_Discovery_Mboard) is a ready-to-use printed circuit board (PBC) which includes:

- On standard edition:
 - An STM32F405VGT6 LQFP100 32-bit microcontroller with 1 Mbyte of Flash memory and 192 + 4 Kbyte of SRAM.
 - LCD color screen (320 x 200 pixels)
 - Touch screen driver
 - Different color LEDs (power, user, WiFi® status)
 - User push button
 - Reset button
 - Joystick for menu selection
 - On board ST link for microcontroller firmware upgrade and debug
 - ST-LINK mini USB
 - User micro USB
 - USB micro or mini connector for board powering
 - Demonstration use cases flashed in memory
- On demonstration edition:
 - All features available on the standard edition
 - A JTAG connector
 - Bluetooth® low-energy module
 - WiFi® module

2.2 MB1285 board features

The MB1285 (ST25DV_Discovery_ANT_C5) is a ready-to-use PCB which includes:

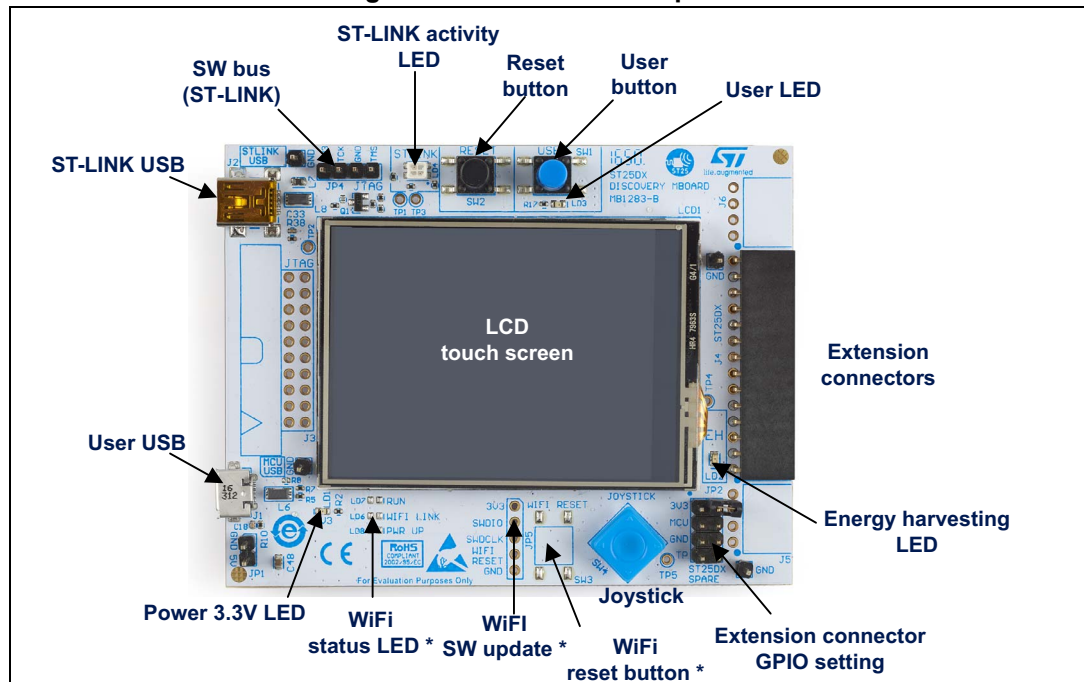
- A ST25DV04K Dynamic NFC/RFID tag IC with 4 Kbits EEPROM which provides a buffering data-transfer capability
- Class 5 single-layer inductive antenna etched on the PCB (ANT C5)

3 Hardware layout

3.1 MB1283 board layout

This section presents the layout of the MB1283 board from a top view (see [Figure 3](#)) and a bottom view (see [Figure 4](#)).

Figure 3. MB1283 board top view



3.2 MB1285 board layout

This section presents the layout of the MB1285 board from a top view (see [Figure 5](#)) and a bottom view (see [Figure 6](#)).

Figure 5. MB1285 board top view

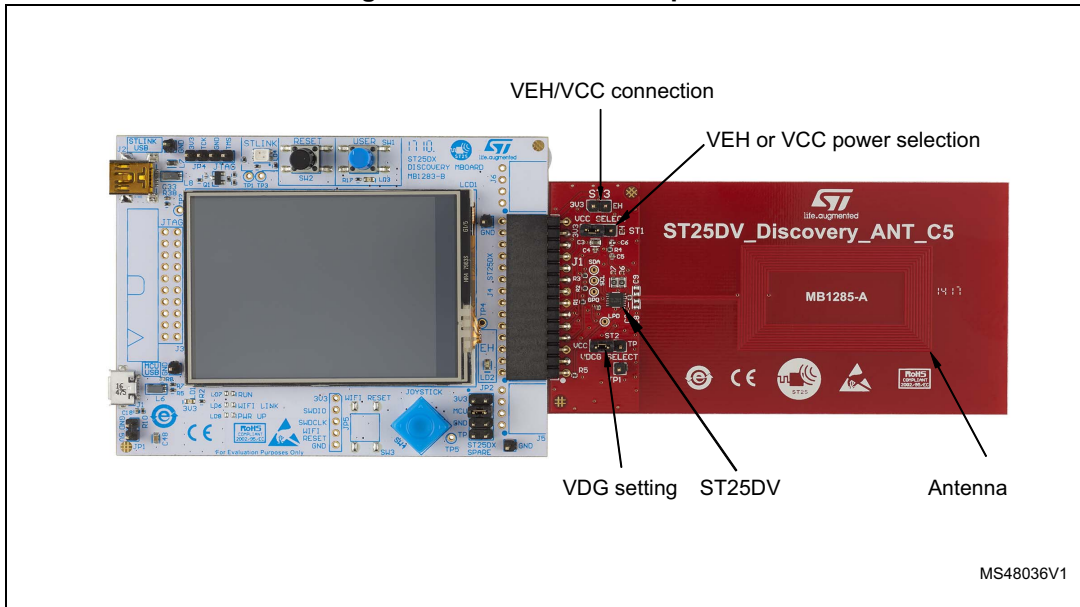
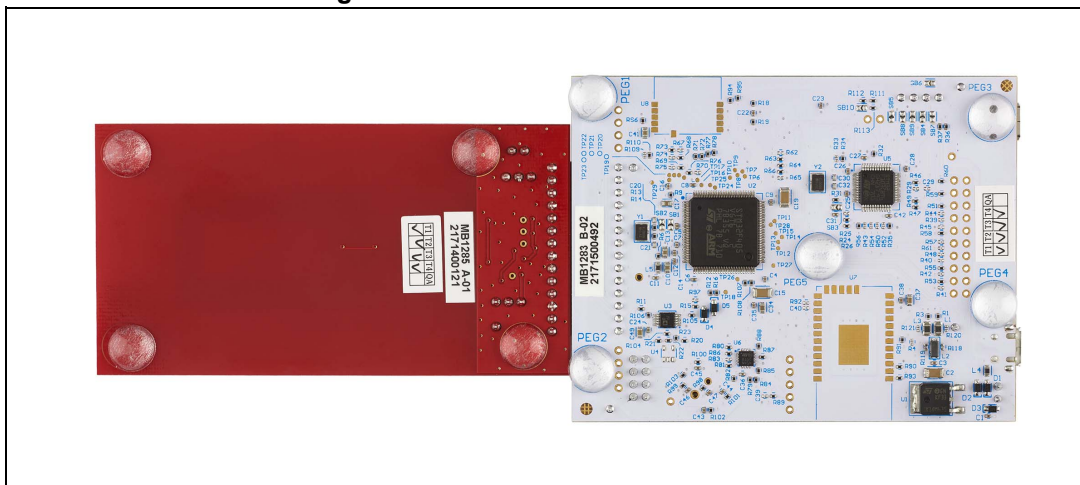


Figure 6. MB1285 board bottom view



4 ST25DV-DISCOVERY kit powering and startup

The mother board and the daughter board must be connected together.

The ST25DV-DISCOVERY kit is powered by an USB bus via a cable connected to the power source (like a PC).

When powered up, the microcontroller starts the firmware, which is already downloaded in the Flash memory. This is a demonstration of the different capabilities of the ST25DV04K (like RF on/off, change vCard message for example). There are no modifications nor configuration to be done on the board to run the demo. Refer to the firmware's user manual available on STMicroelectronics website to get more details.

5 Program and debug the ST25DV-DISCOVERY kit

In order to Flash or debug an STM32 microcontroller application on the ST25DV-DISCOVERY kit, simply connect the mini USB cable.

The on-board ST-LINK in-circuit debugger and programmer allows to start the dedicated tools.

Then, launch the ST-LINK utility PC software (available for download at STMicroelectronics website).

For more information or documentation on the ST-LINK in-circuit debugger and programmer, visit www.st.com.

6 Hardware implementation

The pages hereafter show the ST25DV-DISCOVERY schematics for:

- ST25DX_Discovery_MBoard (board reference MB1283)
- ST25DV_Discovery_ANT_C5 (board reference MB1285).

6.1 MB1283 board schematics

This section presents the schematics for the MB1283 board.

Figure 7. MB1283 schematics - top level

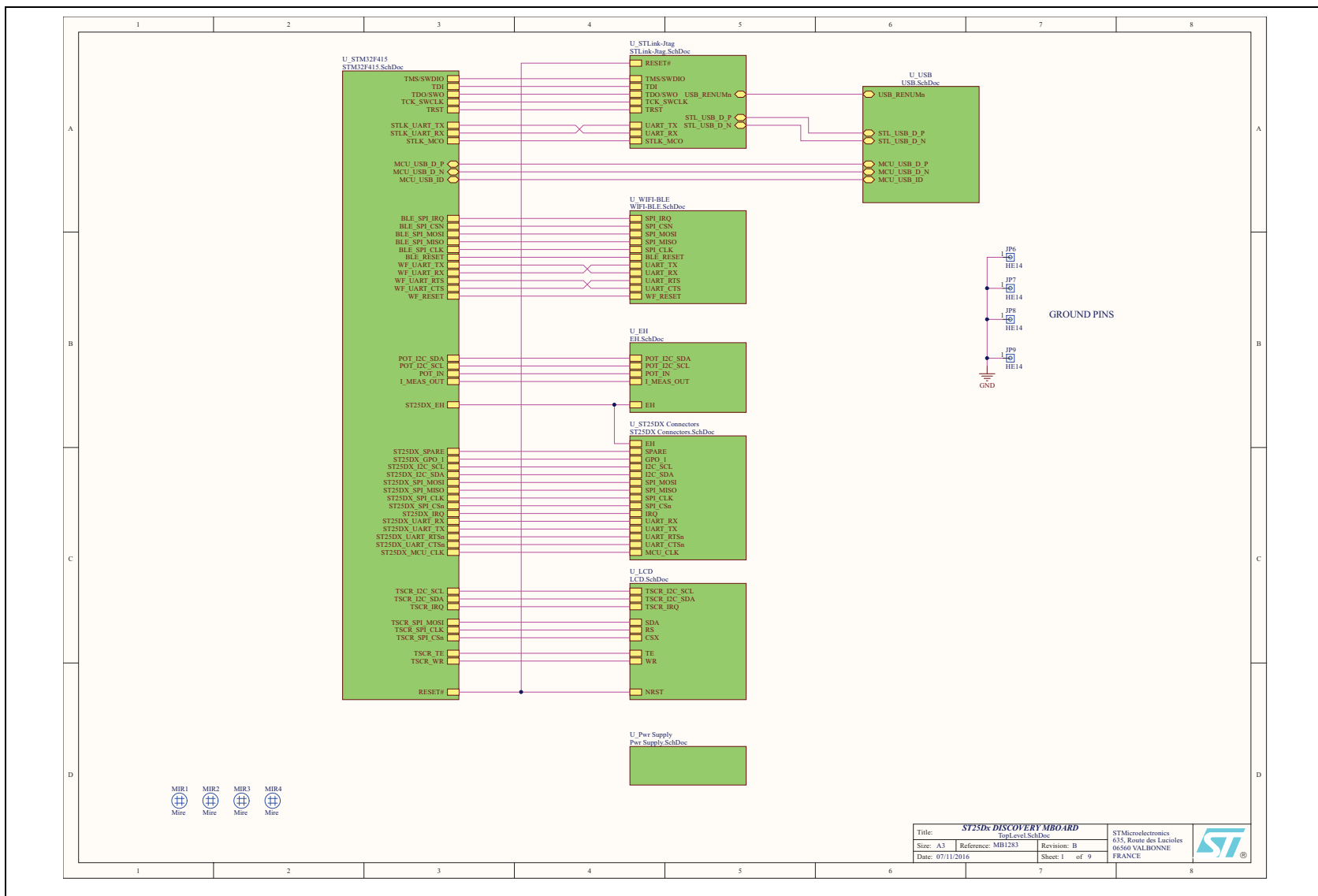
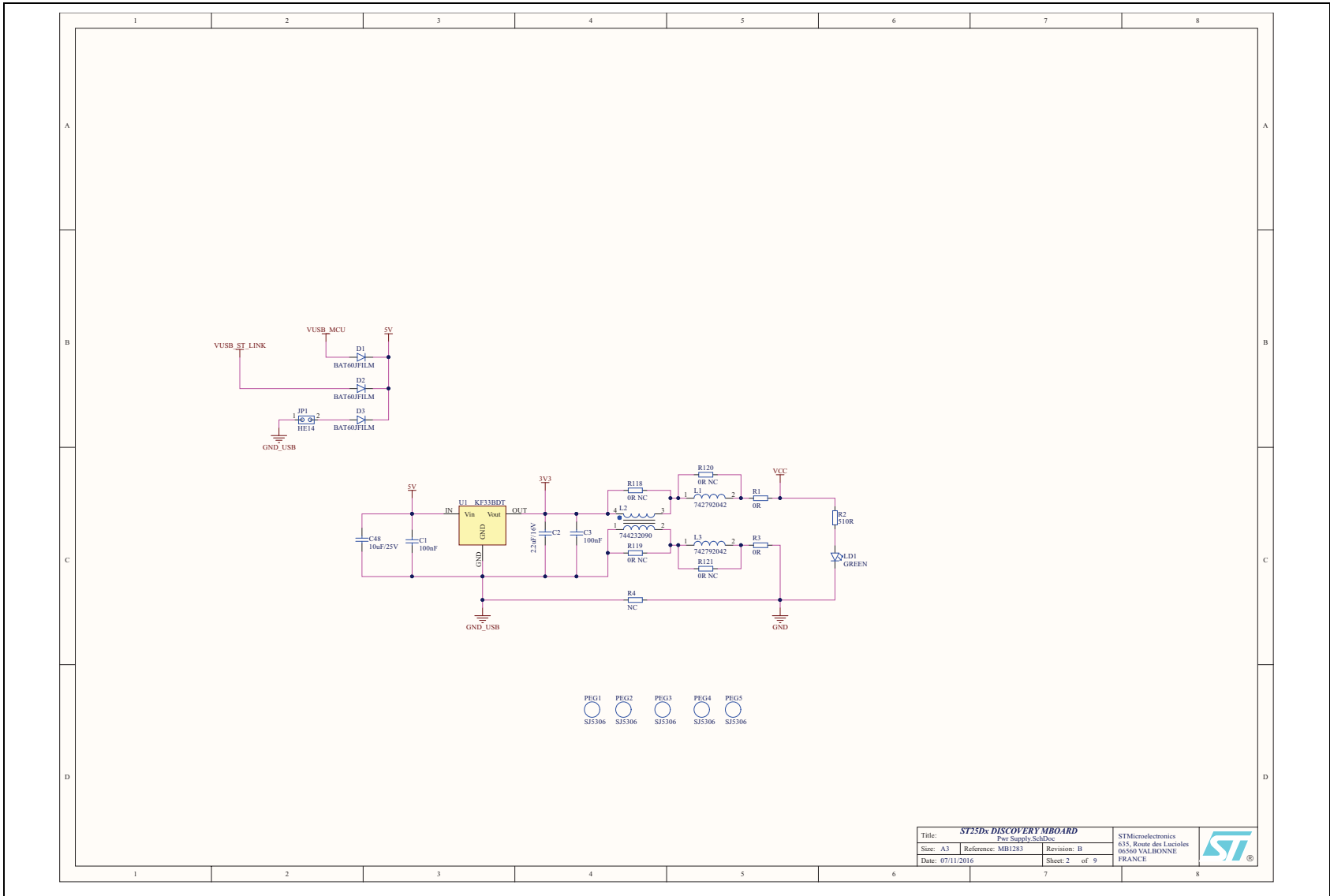


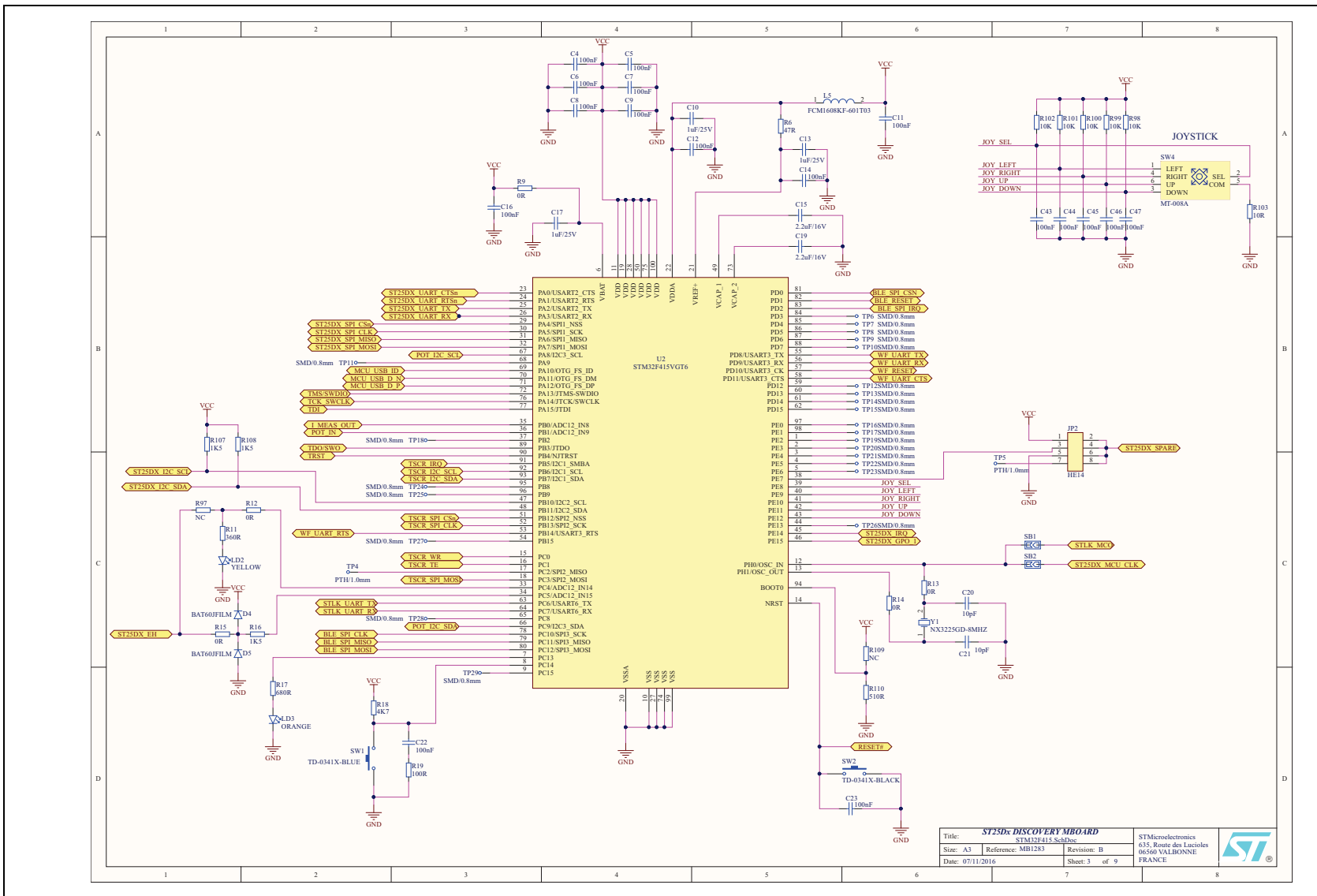


Figure 8. MB1283 schematics - power supply



Title: ST25Dx DISCOVERY MBOARD		STMicroelectronics 635, Route des Lucioles 06560 VALBONNE FRANCE		
Site: A3	Reference: MB1283			Revision: B
Date: 07/11/2016	Sheet: 2			of 9

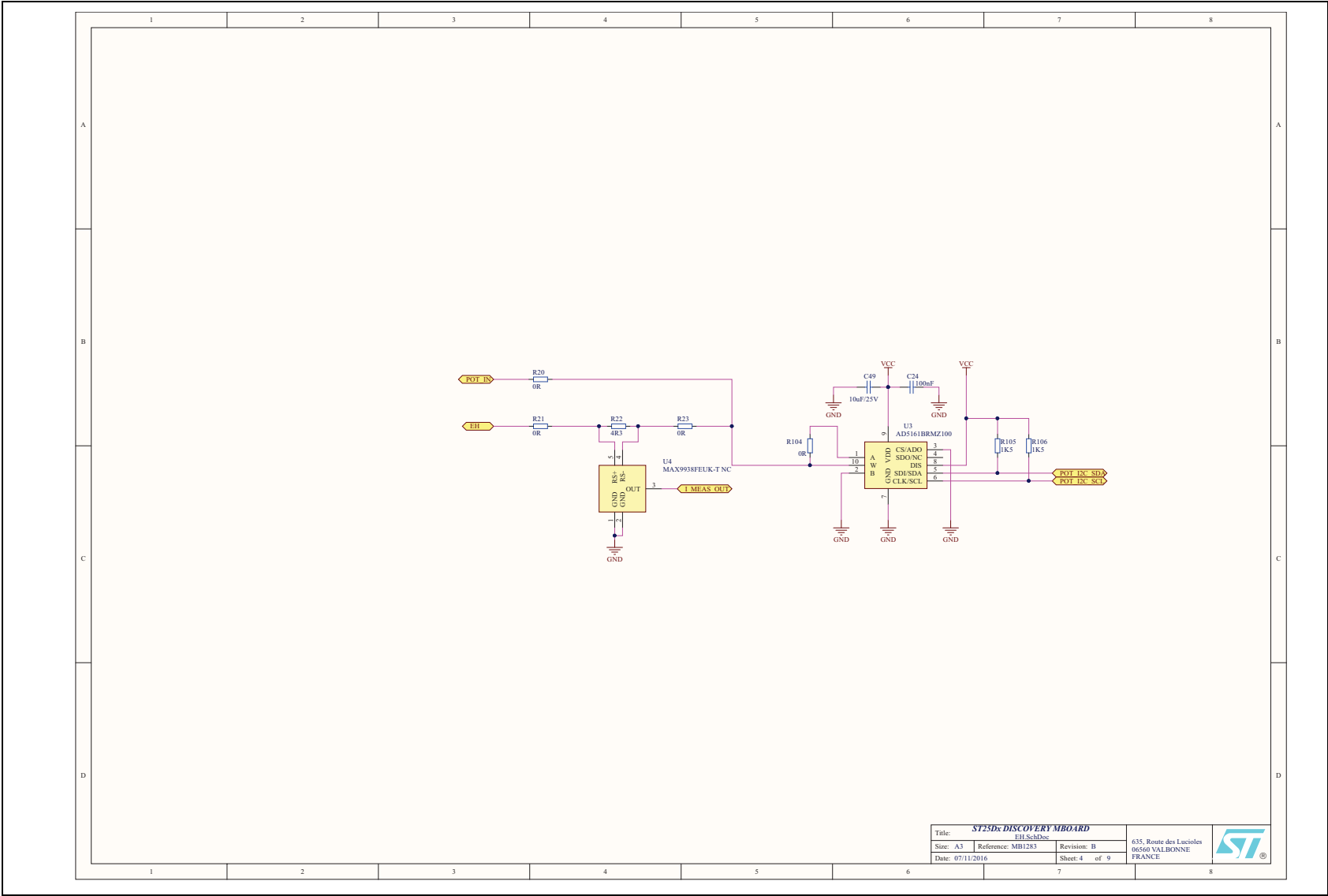
Figure 9. MB1283 schematics - STM32F405



Title:	ST25DX DISCOVERY BOARD	STMicroelectronics
Size:	A3 Reference: MB1283	635, Route des Lucioles
Date:	07/11/2016	92500 VALBOISSE
		FRANCE
		Sheet: 3 of 9



Figure 10. MB1283 schematics - EH

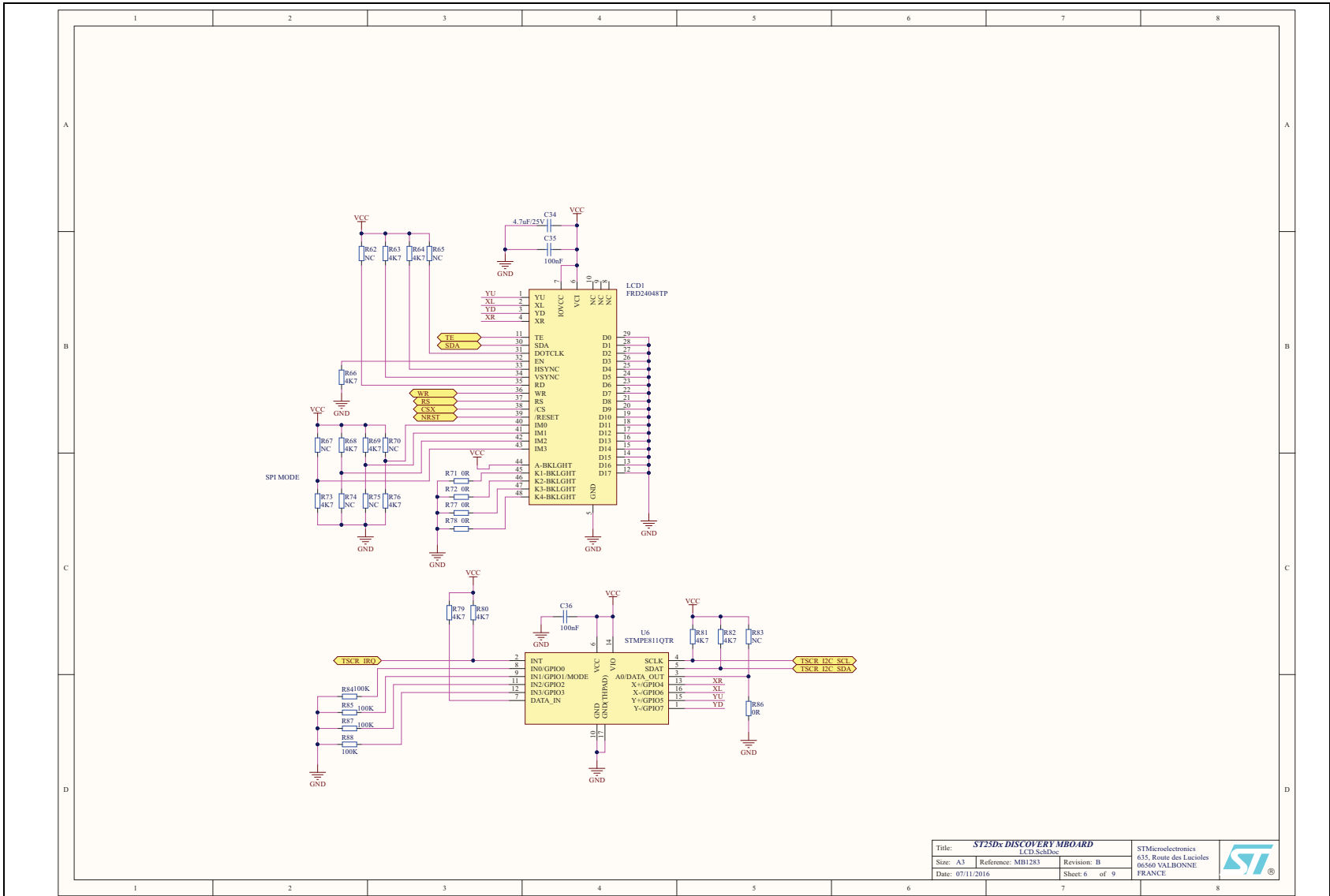


Title: ST2SDx DISCOVERY MBOARD			
U3 Sch80c			
Size: A3	Reference: MB1283	Revision: B	635, Route des Lucioles
Date: 07/11/2016		Sheet 4 of 9	96500 VALBONNE FRANCE



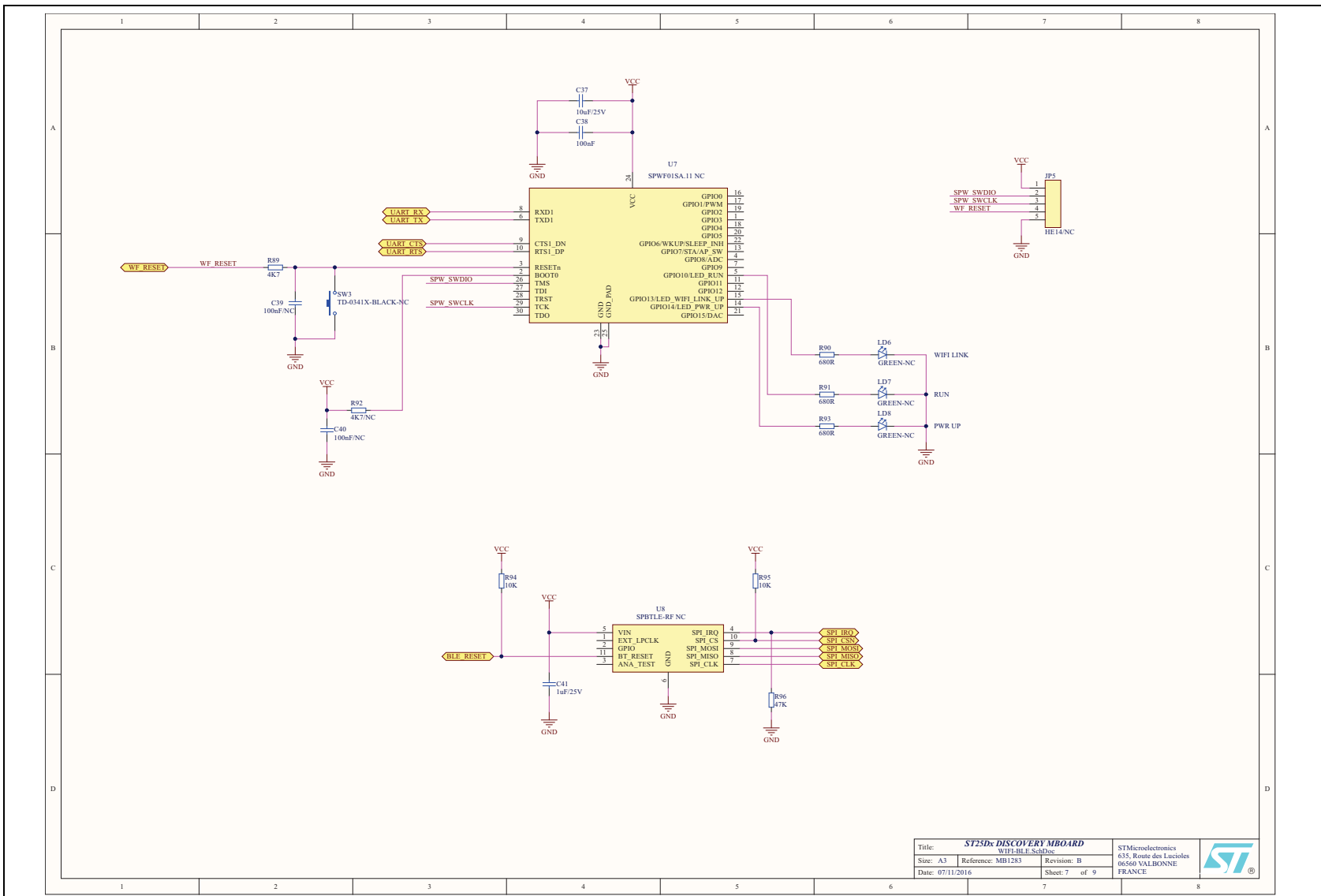


Figure 12. MB1283 schematics - LCD



Title: ST25Dx DISCOVERY MBOARD		STMicroelectronics 635, Route des Lactioles 06560 VALBONNE FRANCE	
LCD SchDoc			
Size: A3	Reference: MB1283		
Date: 07/11/2016		Sheet: 6 of 9	

Figure 13. MB1283 schematics - WiFi® BLE



Title: ST25Dc DISCOVERY MBOARD			
Size: A3 Reference: MB1283 Revision: B			
Date: 07/11/2016	Sheet: 7 of 9	Revision: B	

Figure 14. MB1283 schematics - ST25DX connectors

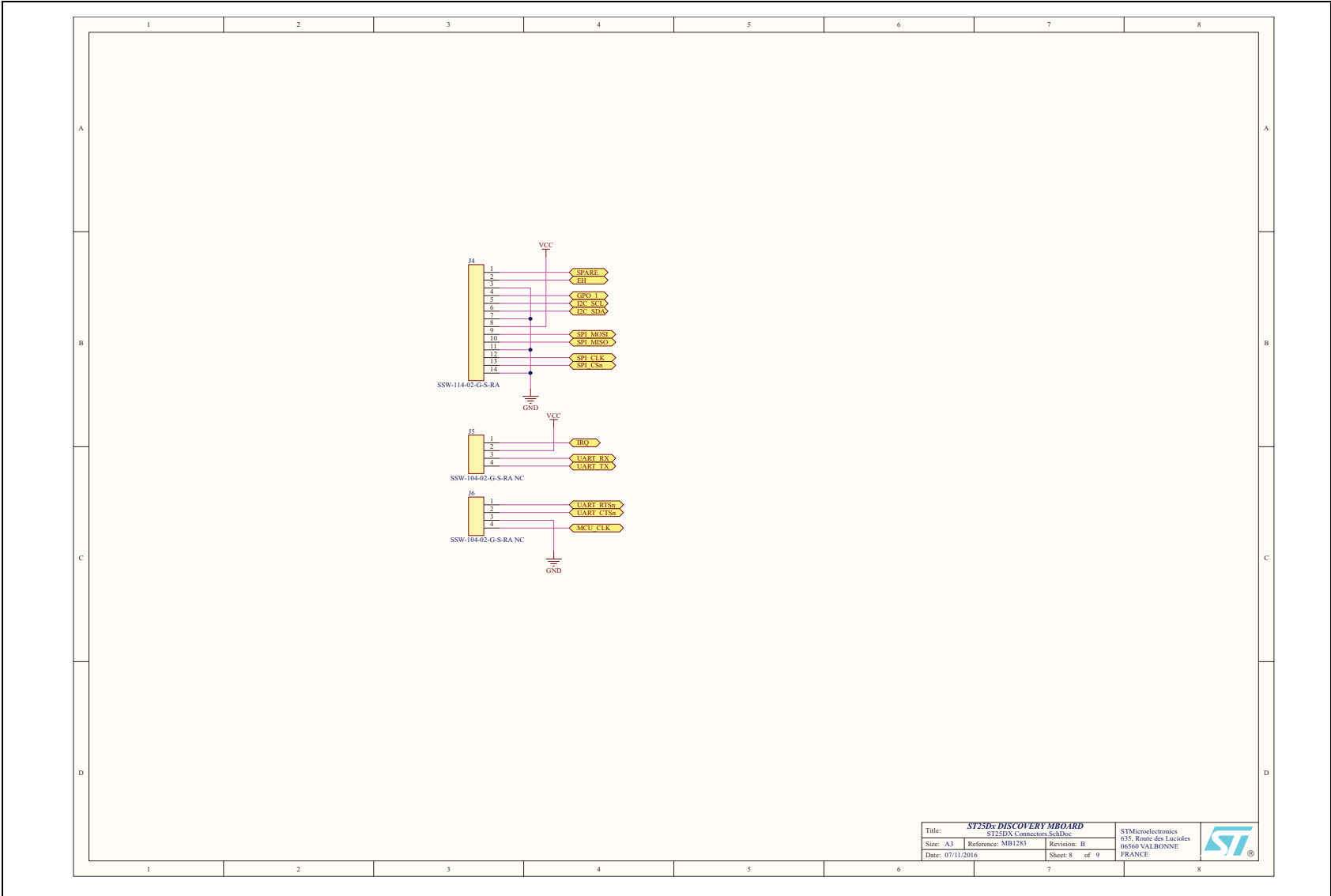
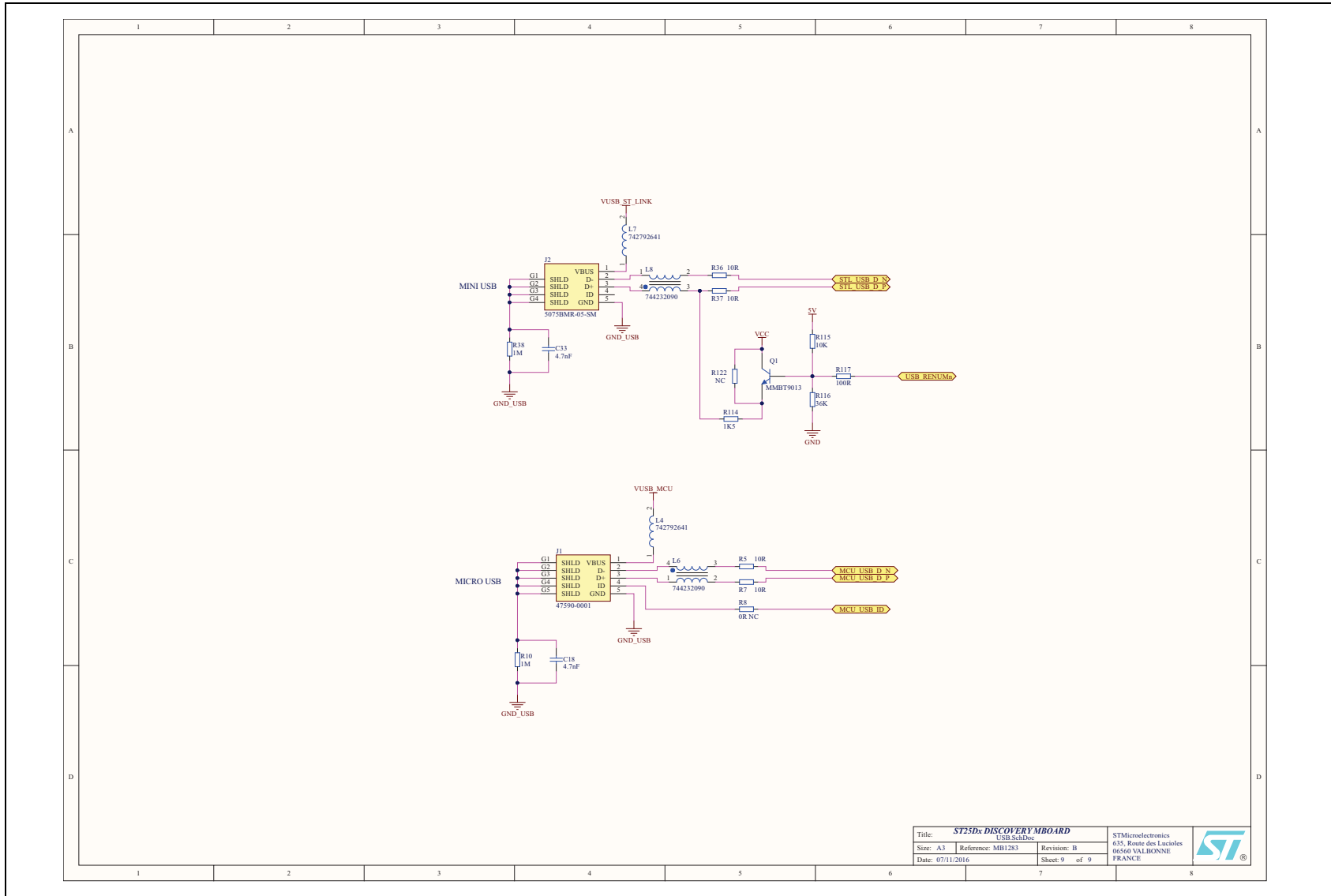


Figure 15. MB1283 schematics - USB



Title: ST25x DISCOVERY MBOARD		USB_Sch1Doc	
Size: A3	Reference: MB1283	Revision: B	Sheet 9 of 9
Date: 07/11/2016			

STMicroelectronics
635, Route des Lucioles
06560 VALBONNE
FRANCE

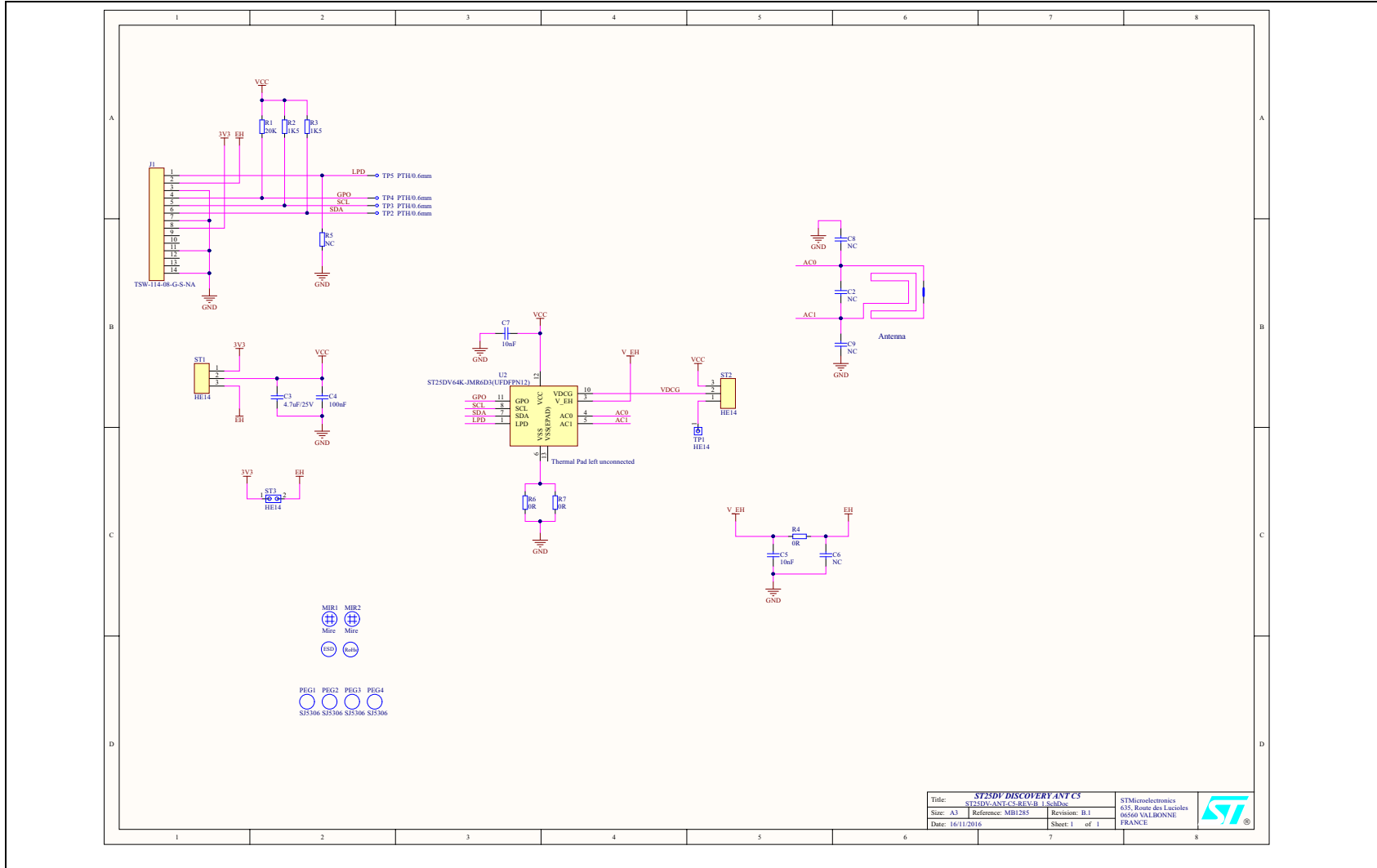




6.2 MB1285 board schematics

This section presents the schematics for the MB1285 board.

Figure 16. MB1285 board schematics



Title: ST25DV DISCOVERY ANT CS		
Doc: A3	Reference: MB1285	
Date: 16/11/2016	Revision: B.1	

7 Revision history

Table 1. Document revision history

Date	Revision	Changes
23-Feb-2017	1	Initial release.
12-Sep-2017	2	Updated: <ul style="list-style-type: none">– Section 2.1: MB1283 board features– Section 6.2: MB1285 board schematics– Figure 1: ST25DV-DISCOVERY mother board and daughter board– Figure 5: MB1285 board top view– Figure 6: MB1285 board bottom view– Figure 16: MB1285 board schematics

IMPORTANT NOTICE – PLEASE READ CAREFULLY

STMicroelectronics NV and its subsidiaries ("ST") reserve the right to make changes, corrections, enhancements, modifications, and improvements to ST products and/or to this document at any time without notice. Purchasers should obtain the latest relevant information on ST products before placing orders. ST products are sold pursuant to ST's terms and conditions of sale in place at the time of order acknowledgement.

Purchasers are solely responsible for the choice, selection, and use of ST products and ST assumes no liability for application assistance or the design of Purchasers' products.

No license, express or implied, to any intellectual property right is granted by ST herein.

Resale of ST products with provisions different from the information set forth herein shall void any warranty granted by ST for such product.

ST and the ST logo are trademarks of ST. All other product or service names are the property of their respective owners.

Information in this document supersedes and replaces information previously supplied in any prior versions of this document.

© 2017 STMicroelectronics – All rights reserved