

Features

- GaN on Si HEMT D-Mode Transistor
- Suitable for linear and saturated applications
- Tunable from DC - 2.5 GHz
- 48 V Operation
- 16.5 dB Gain at 2.5 GHz
- 55 % Drain Efficiency at 2.5 GHz
- 100 % RF Tested
- TO-272 Package
- RoHS* Compliant and 260°C reflow compatible



Description

The NPT2021 GaN HEMT is a wideband transistor optimized for DC - 2.5 GHz operation. This device supports CW, pulsed, and linear operation with output power levels to 45 W in an industry standard plastic package with bolt down flange.

The NPT2021 is ideally suited for defense communications, land mobile radio, avionics, wireless infrastructure, ISM applications and VHF/ UHF/L/S-band radar.

Built using the SIGANTIC® process - a proprietary GaN-on-Silicon technology.

Functional Schematic

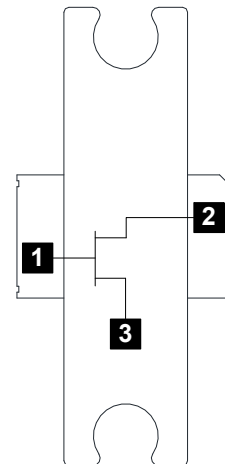

Pin Configuration

Pin No.	Pin Name	Function
1	RF _{IN} / V _G	RF Input / Gate
2	RF _{OUT} / V _D	RF Output / Drain
3	Pad ¹	Ground / Source

1. The exposed pad centered on the package bottom must be connected to RF and DC ground. This path must also provide a low thermal resistance heat path.

Ordering Information

Part Number	Package
NPT2021	Bulk Quantity
NPT2021-SMBPPR	Sample Board

* Restrictions on Hazardous Substances, European Union Directive 2011/65/EU.

GaN Wideband Transistor 48 V, 45 W DC - 2.5 GHz

Rev. V1

RF Electrical Specifications: $T_C = 25^\circ\text{C}$, $V_{DS} = 48\text{ V}$, $I_{DQ} = 350\text{ mA}$

Parameter	Test Conditions	Symbol	Min.	Typ.	Max.	Units
Small Signal Gain	CW, 2.5 GHz	G_{SS}	-	14.2	-	dB
Saturated Output Power	CW, 2.5 GHz	P_{SAT}	-	47.5	-	dBm
Drain Efficiency at Saturation	CW, 2.5 GHz	η_{SAT}	-	65	-	%
Power Gain	2.5 GHz, $P_{OUT} = 45\text{ W}$	G_P	12	12.8	-	dB
Drain Efficiency	2.5 GHz, $P_{OUT} = 45\text{ W}$	η	45	50	-	%
Ruggedness: Output Mismatch	All phase angles	Ψ	VSWR = 15:1, No Device Damage			

DC Electrical Characteristics: $T_C = 25^\circ\text{C}$

Parameter	Test Conditions	Symbol	Min.	Typ.	Max.	Units
Drain-Source Leakage Current	$V_{GS} = -8\text{ V}$, $V_{DS} = 160\text{ V}$	I_{DLK}	-	-	14	mA
Gate-Source Leakage Current	$V_{GS} = -8\text{ V}$, $V_{DS} = 0\text{ V}$	I_{GLK}	-	-	7	mA
Gate Threshold Voltage	$V_{DS} = 48\text{ V}$, $I_D = 14\text{ mA}$	V_T	-2.5	-1.8	-0.5	V
Gate Quiescent Voltage	$V_{DS} = 48\text{ V}$, $I_D = 350\text{ mA}$	V_{GSQ}	-2.1	-1.5	-0.3	V
On Resistance	$V_{DS} = 2\text{ V}$, $I_D = 105\text{ mA}$	R_{ON}	-	0.34	-	Ω
Saturated Drain Current	$V_{DS} = 7\text{ V}$ pulsed, pulse width 300 μs	$I_{D(SAT)}$	-	8.2	-	A

Absolute Maximum Ratings^{2,3,4}

Parameter	Absolute Maximum
Drain Source Voltage, V_{DS}	160 V
Gate Source Voltage, V_{GS}	-10 to 3 V
Gate Current, I_G	24 mA
Junction Temperature, T_J	+200°C
Operating Temperature	-40°C to +85°C
Storage Temperature	-65°C to +150°C

2. Exceeding any one or combination of these limits may cause permanent damage to this device.
3. MACOM does not recommend sustained operation near these survivability limits.
4. Operating at nominal conditions with $T_J \leq 200^\circ\text{C}$ will ensure $\text{MTTF} > 1 \times 10^6$ hours.

Thermal Characteristics⁵

Parameter	Test Conditions	Symbol	Typical	Units
Thermal Resistance	$V_{DS} = 48 \text{ V}, T_J = 200^\circ\text{C}$	$R_{\theta JC}$	1.60	°C/W

5. Junction temperature (T_J) measured using IR Microscopy. Case temperature measured using thermocouple embedded in heat-sink.

Handling Procedures

Please observe the following precautions to avoid damage:

Static Sensitivity

Gallium Nitride Circuits are sensitive to electrostatic discharge (ESD) and can be damaged by static electricity. Proper ESD control techniques should be used when handling these HBM Class 1B devices.

GaN Wideband Transistor 48 V, 45 W DC - 2.5 GHz

Rev. V1

Load-Pull Performance: $V_{DS} = 48\text{ V}$, $I_{DQ} = 350\text{ mA}$, $T_C = 25^\circ\text{C}$

Reference Plane at Device Leads, CW Drain Efficiency and Output Power Tradeoff Impedance

Frequency (MHz)	Z_S (Ω)	Z_L (Ω)	P_{SAT} (W)	G_{SS} (dB)	Drain Efficiency @ P_{SAT} (%)
900	$1.1 + j0.7$	$7.3 + j5.5$	74	24	68
2000	$1.4 - j6.1$	$2.9 + j2.4$	65	17	68
2500	$1.5 - j7.6$	$2.3 + j0.6$	64	14	65

Impedance Reference

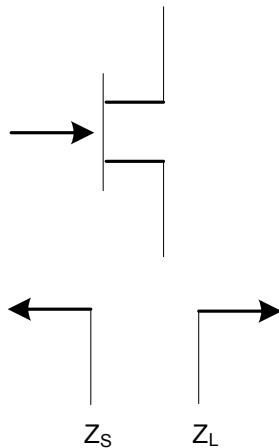

Z_S and Z_L vs. Frequency

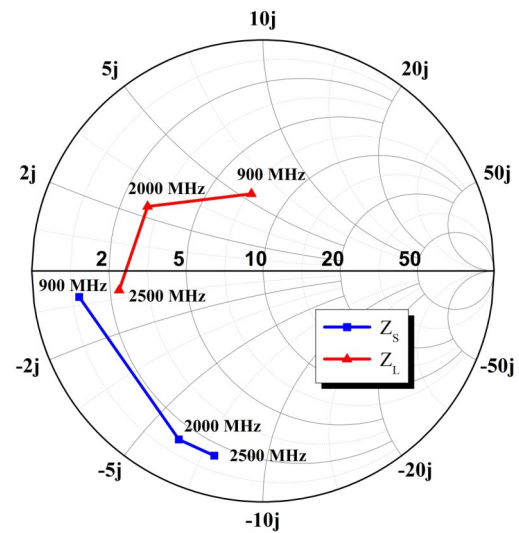

Gain vs. Output Power

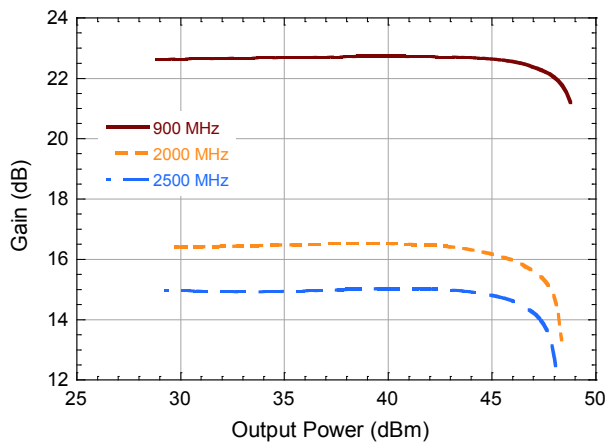

Drain Efficiency vs. Output Power

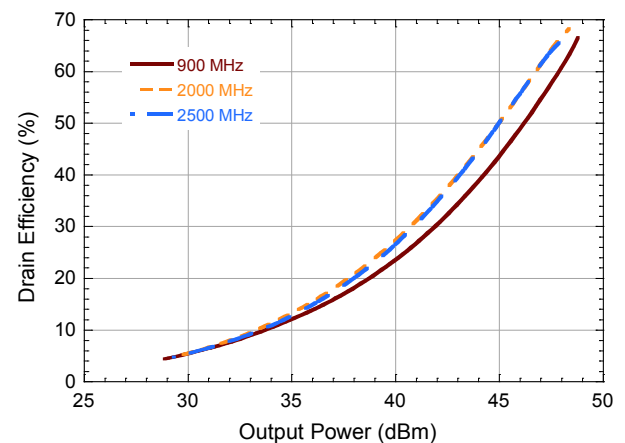

Evaluation Board and Recommended Tuning Solution
2.5 GHz Narrowband Circuit

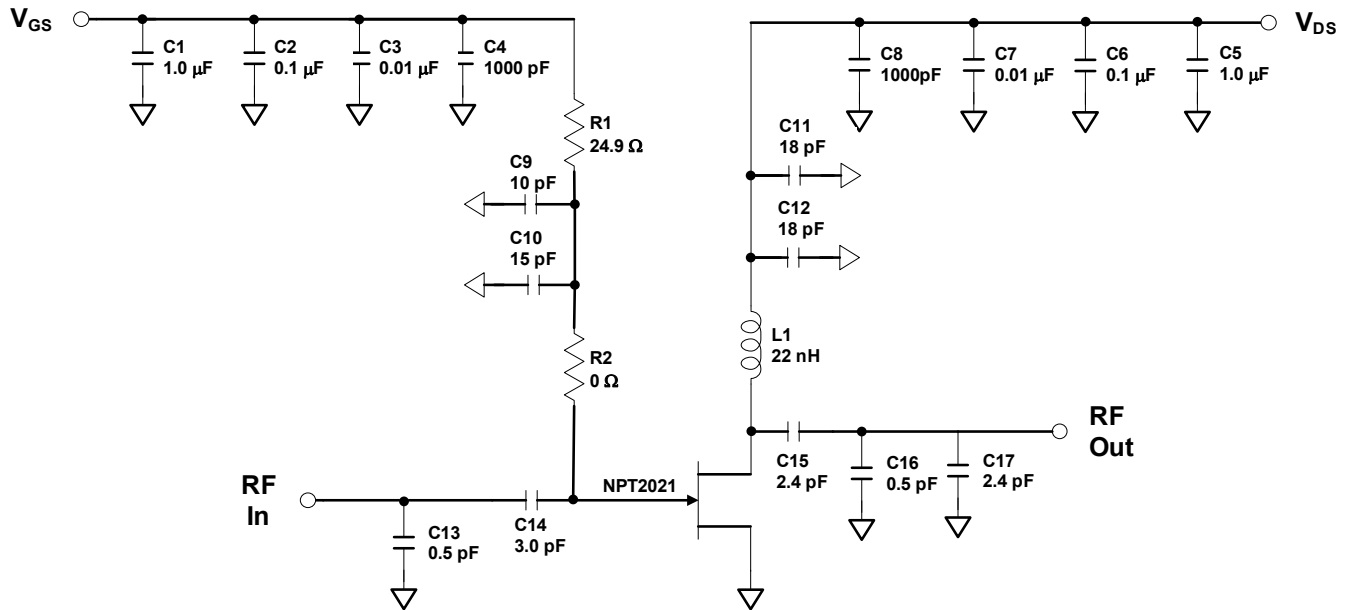

Description

Parts measured on evaluation board (30-mil thick RO4350). The PCB's electrical and thermal ground is provided using a standard-plated densely packed via hole array (see recommended via pattern).

Matching is provided using a combination of lumped elements and transmission lines as shown in the simplified schematic above. Recommended tuning solution component placement, transmission lines, and details are shown on the next page.

Bias Sequencing

Turning the device ON

1. Set V_{GS} to the pinch-off (V_P), typically -5 V.
2. Turn on V_{DS} to nominal voltage (48 V).
3. Increase V_{GS} until the I_{DS} current is reached.
4. Apply RF power to desired level.

Turning the device OFF

1. Turn the RF power off.
2. Decrease V_{GS} down to V_P .
3. Decrease V_{DS} down to 0 V.
4. Turn off V_{GS} .

Evaluation Board and Recommended Tuning Solution
2.5 GHz Narrowband Circuit

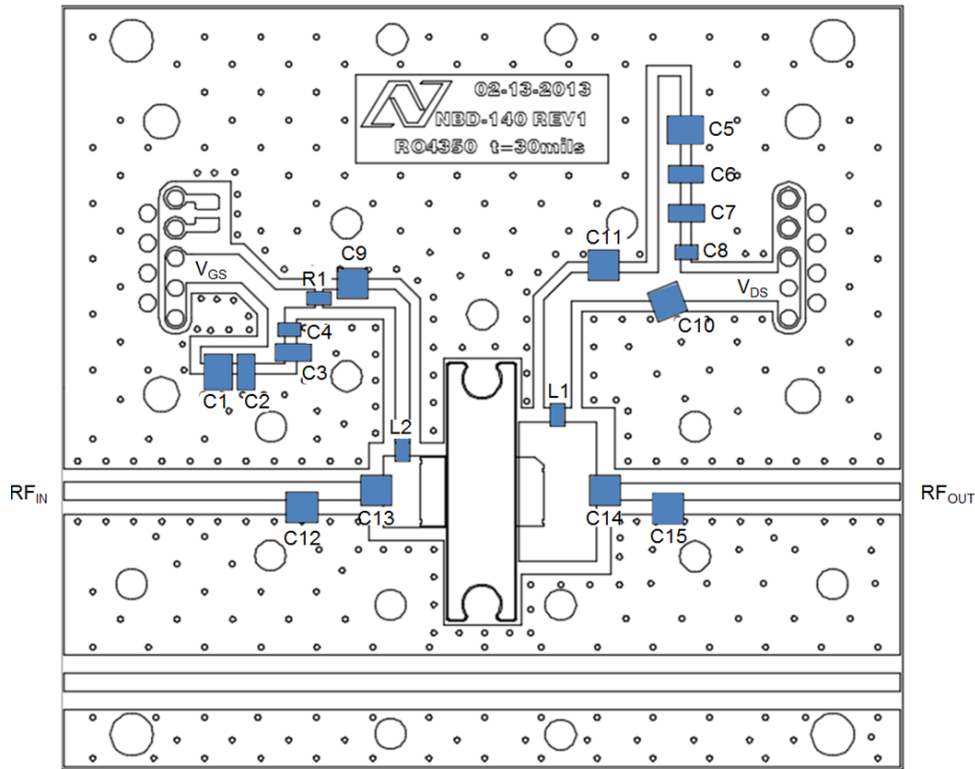

Parts list

Reference	Value	Tolerance	Manufacturer	Part Number
C1, C5	1.0 μ F	10 %	AVX	1210C105KAT2A
C2, C6	0.1 μ F	10 %	Kemet	C1206C104K1RACTU
C3, C7	0.01 μ F	10 %	AVX	12061C103KAT2A
C4, C8	1000 pF	10 %	Kemet	C0805C102K1RACTU
C9	10 pF	5 %	ATC	ATC800A100J
C10, C11	18 pF	10 %	ATC	ATC800B180K
C12	3.6 pF	0.1 pF	Murata	GQM22M5C2H3R6BB01
C13	1.5 pF	0.1 pF	Murata	GQM22M5C2H1R5BB01
C14, C15	2.4 pF	0.1 pF	ATC	ATC800B2R4B
L1, L2	22 nH	5%	Coilcraft	0807SQ-22N_LB
R1	24.9 Ω	1 %	Panasonic	ERJ-SIDF49R9U-ND
PCB	Rogers RO4350, $\epsilon_r = 3.5$, 30 mil			

GaN Wideband Transistor 48 V, 45 W DC - 2.5 GHz

Rev. V1

Typical Performance as measured in the 2.5 GHz evaluation board:
CW, $V_{DS} = 48\text{ V}$, $I_{DQ} = 350\text{ mA}$ (unless noted)

Gain vs. Output Power over Temperature

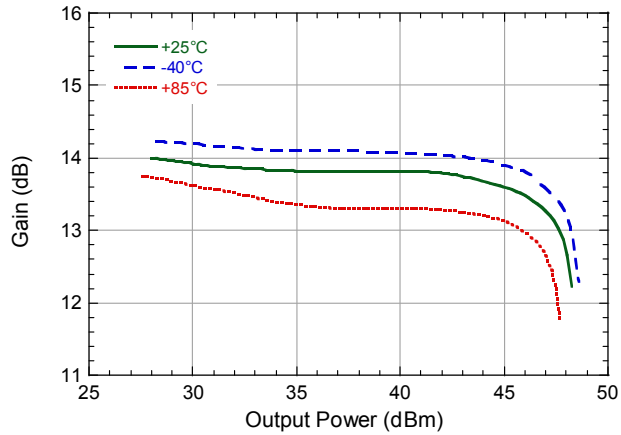

Drain Efficiency vs. Output Power over Temperature

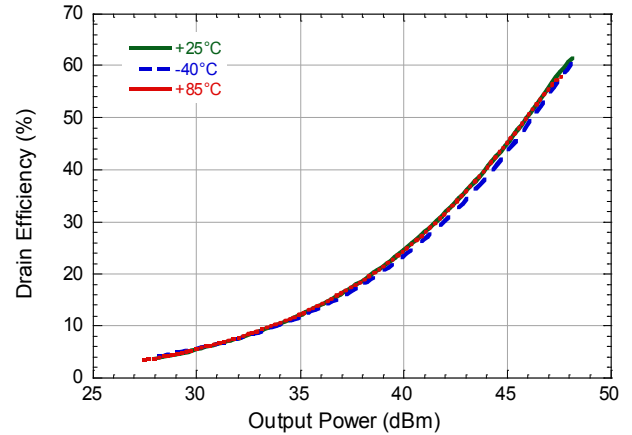

Quiescent V_{GS} vs. Temperature

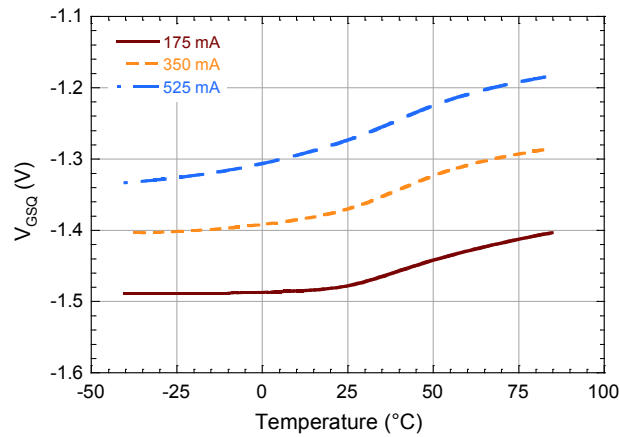

GaN Wideband Transistor 48 V, 45 W DC - 2.5 GHz

Rev. V1

Typical 2-Tone Performance as measured in the 2.5 GHz evaluation board:
1 MHz Tone Spacing, $V_{DS} = 48\text{ V}$, $I_{DQ} = 350\text{ mA}$, $T_C = 25^\circ\text{C}$ (unless noted)

2-Tone IMD3 vs. Output Power vs. Quiescent Current

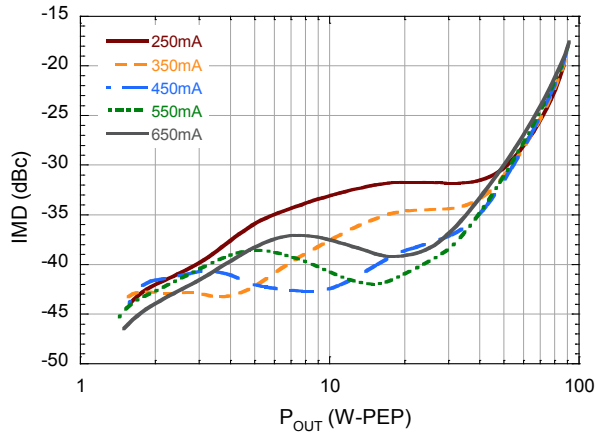

2-Tone Gain vs. Output Power vs. Quiescent Current

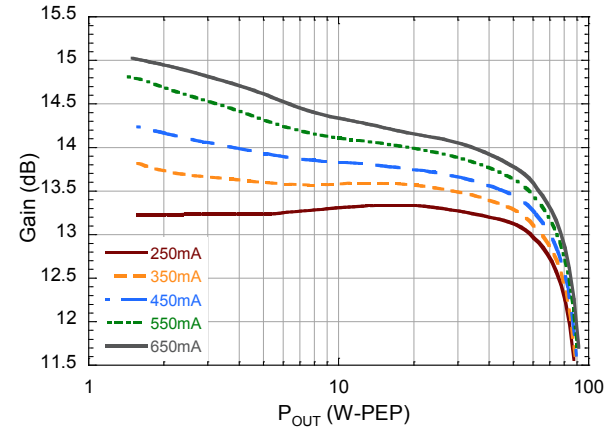

2-Tone IMD vs. Output Power

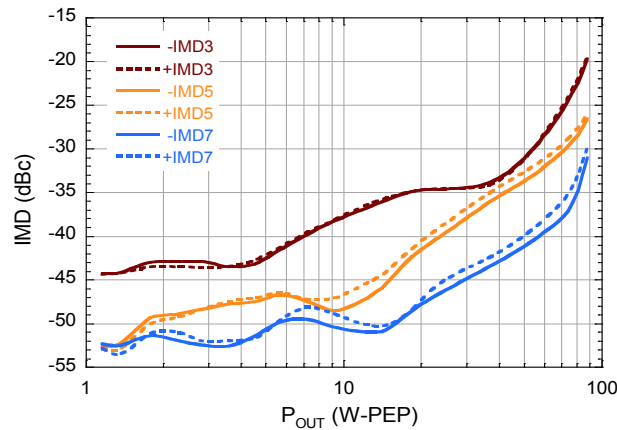

TO-272-2 Plastic Package†

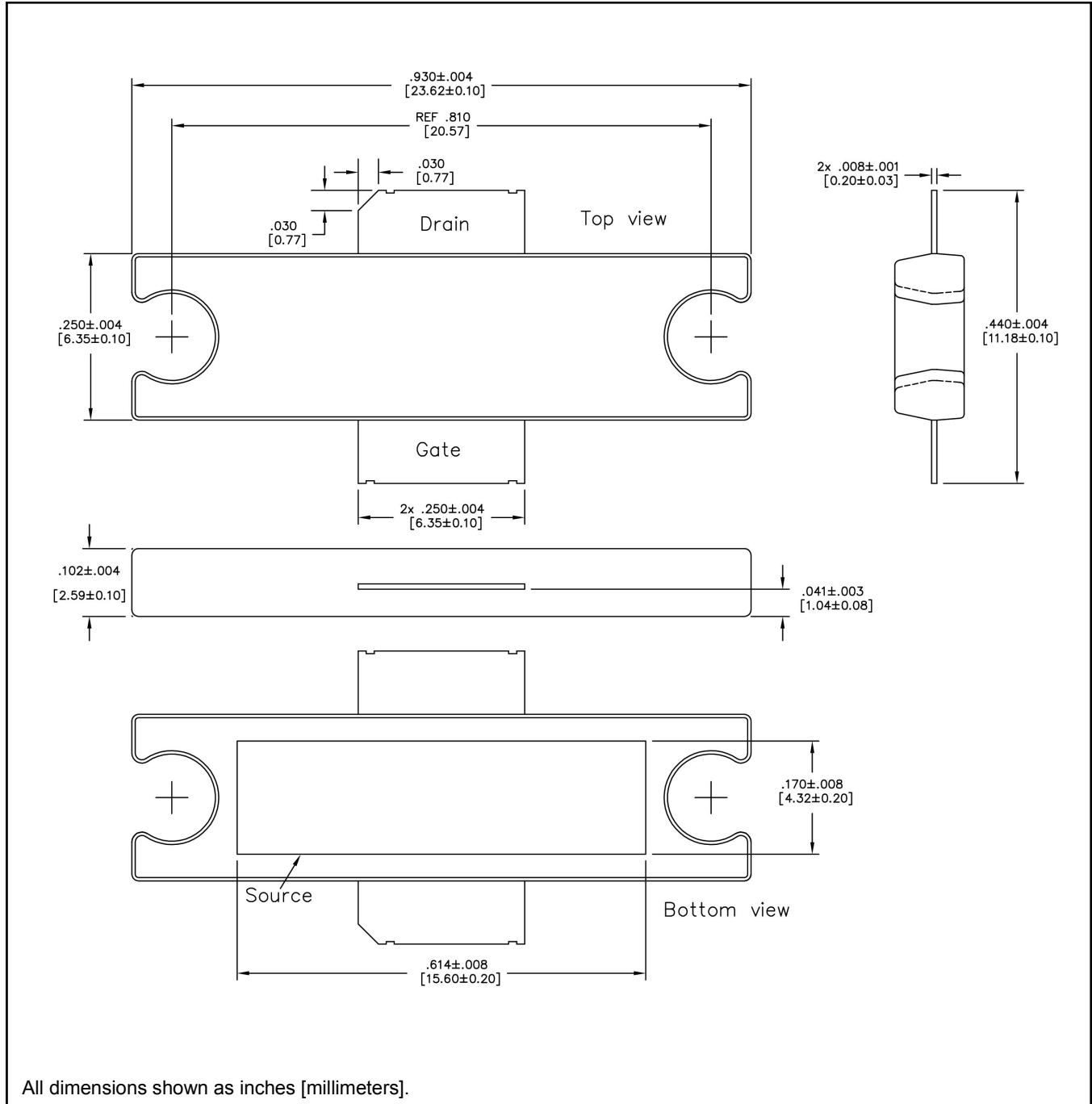

† Meets JEDEC moisture sensitivity level 3 requirements.
 Plating is Matte Sn .