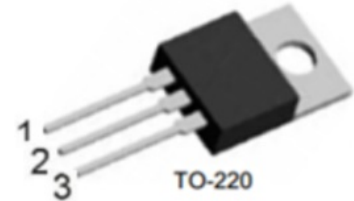
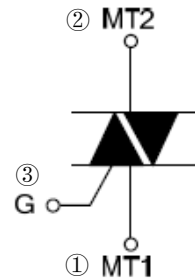

Description

Triacs is fabricated using separation diffusion processes ,the junction termination areas are passivated with glass. Thanks to highly sensitive triggering levels and reliability,the Triacs series is suitable for domestic lighting ,heating and motor speed controllers.

Applications

Domestic lighting ,heating and motor speed controllers.

Symbol

Ordering Information

Part No.	Package	Packing
BT138-600E	TO-220	50pcs / Tube
BT138-800E	TO-220	50pcs / Tube
BT138F-600E	ITO-220	50pcs / Tube
BT138F-800E	ITO-220	50pcs / Tube

ABSOLUTE MAXIMUM RATING

PARAMETER	SYMBOL	RATINGS	UNIT
Repetitive Peak Off State Voltage	V _{DRM}	600	V
		800*	
RMS On-state Current (Full sine wave; T _{mb} ≤107°C)	I _{T(RMS)}	..	A
Non-Repetitive Peak. On-State Current (Full sine wave; T _j =25°C prior to surge) t = 20 ms	I _{TSM}	95	A
I ² t For Fusing t=10ms	I ² t	45	A ² s
Rate of Rise of On-state Current I _{TM} =20A; I _G =0.2A, dI _G /dt=0.2A/μs	dI _T /dt	T2+G+	A/μs
		T2+G-	
		T2-G-	
		T2-G+	
Peak Gate Voltage	V _{GM}	5	V
Peak Gate Current	I _{GM}	2	A
Peak Gate Power	P _{GM}	5	W
Average Gate Power (Over any 20ms period)	P _{G(AV)}	0.5	W
Operating Junction Temperature	T _j	125	°C
Storage Temperature	T _{stg}	-40~150	°C

*Although not recommended, off-state voltages up to 800V may be applied without damage, but the triac may switch to the on-state. The rate of rise of current should not exceed 6A/μs.

THERMAL CHARACTERISTICS

PARAMETER	SYMBOL	MIN	TYP	MAX	UNIT
Thermal Resistance Junction to Mounting Base Full cycle Half cycle	Rth j-mb			2.0 2.4	K/W
Thermal Resistance Junction to Ambient In free air	Rth j-a		60		K/W

ELECTRICAL CHARACTERISTICS ($T_J = 25^\circ\text{C}$, unless otherwise stated)

PARAMETER	SYMBOL	TEST CONDITIONS	MIN	TYP	MAX	UNIT
STATIC CHARACTERISTICS						
Gate Trigger Current	I _{GT}	V _D =12V, I _T =0.1A T2+G+ T2+G- T2-G- T2-G+		2.5 4 5 11	10 10 10 25	mA
Latching Current	I _L	V _D =12V, I _T =0.1A T2+G+ T2+G- T2-G- T2-G+		- - - -	30 40 30 40	mA
Holding Current	I _H	V _D =12V, I _T =0.1A		-	30	mA
Gate Trigger Voltage	V _{GT}	V _D =12V, I _T =0.1A; T _J =25°C V _D =400V, I _T =0.1A; T _J =125°C		0.7 0.25	1.0	V V
On-State Voltage	V _T	I _T =15A		1.4	1.65	V
Off-state Leakage Current	I _D	V _D =600V, T _J =125°C		0.1	0.5	mA
DYNAMIC CHARACTERISTICS						
Critical Rate of Rise of off-state Voltage	dV _D /dt	V _{DM} =67% V _{DRM(max)} , T _J =125°C Exponential waveform, Gate open circuit		150		V/μs
Gate Controlled Turn-on Time	t _{gt}	I _{TM} =16A, V _D =V _{DRM} , I _G =0.1A dI _G /dt=5A/μs		2		μs

TYPICAL CHARACTERISTICS

Fig. 1. RMS on-state current as a function of mounting base temperature; maximum values



$f = 50 \text{ Hz}; T_{mb} = 99 \text{ }^\circ\text{C}$

Fig. 2. RMS on-state current as a function of surge duration; maximum values

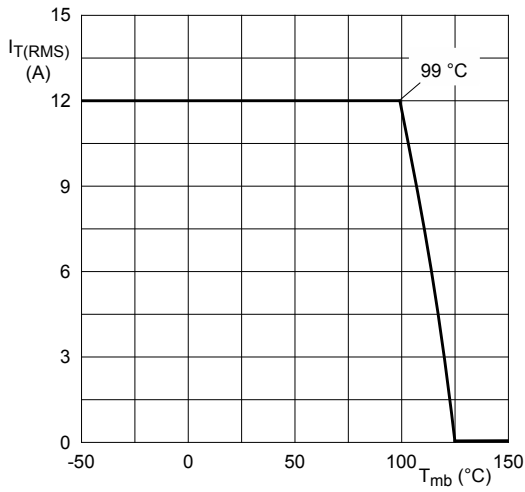
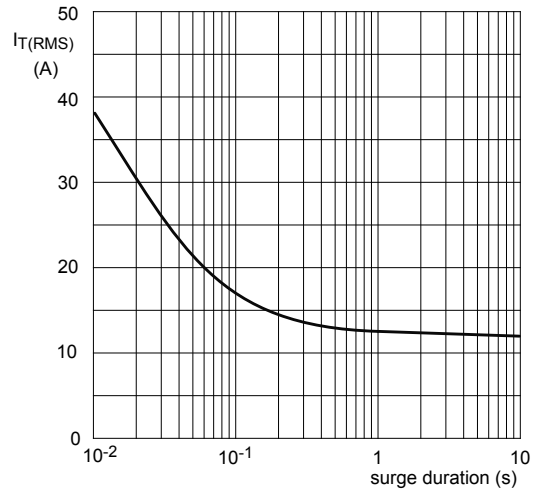
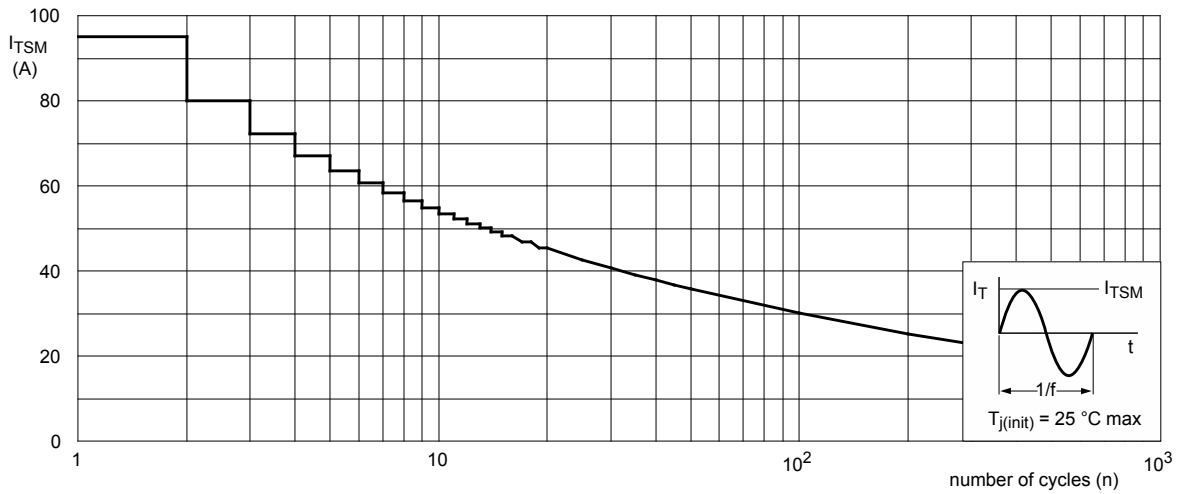

$f = 50 \text{ Hz}$

Fig. 3. Non-repetitive peak on-state current as a function of the number of sinusoidal current cycles; maximum values

TYPICAL CHARACTERISTICS

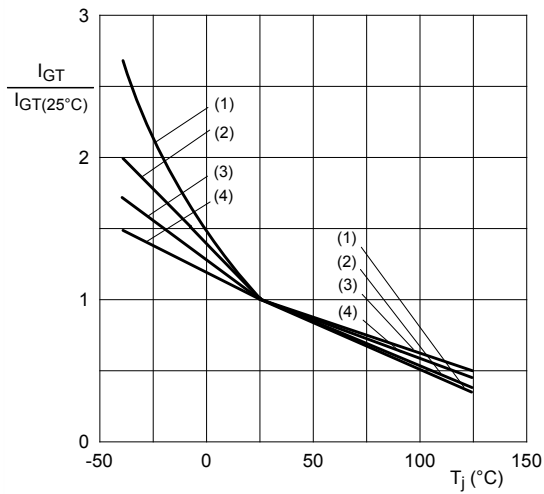

- (1) T2- G+
- (2) T2- G-
- (3) T2+ G-
- (4) T2+ G+

Fig. 4. Normalized gate trigger current as a function of junction temperature

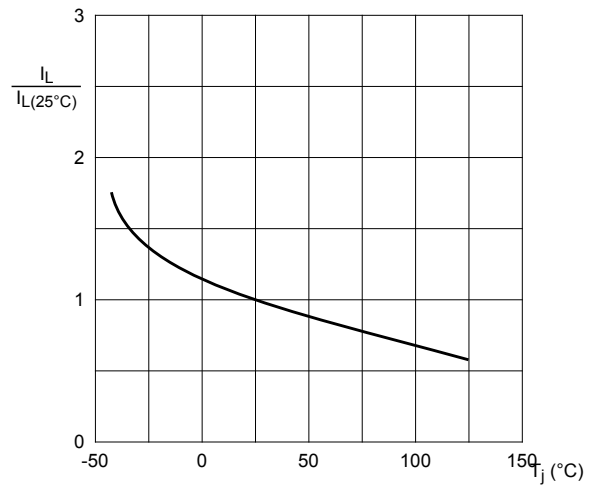

Fig. 5. Normalized latching current as a function of junction temperature

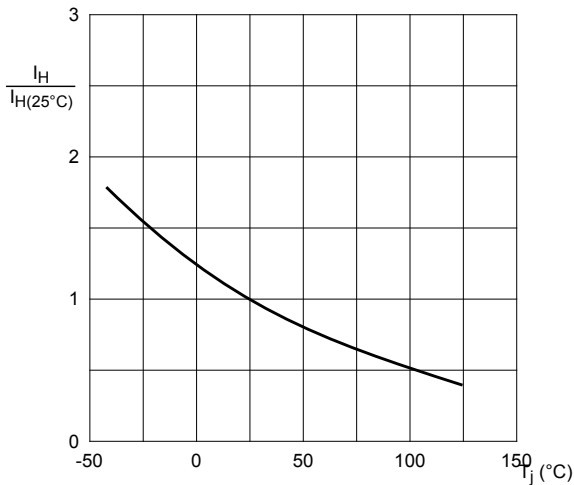
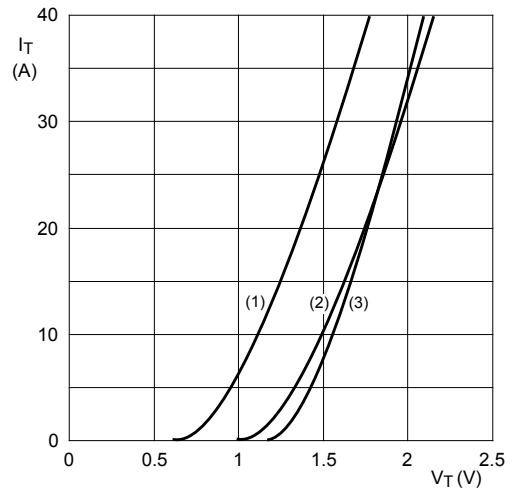

Fig. 6. Normalized holding current as a function of junction temperature



- $V_o = 1.175 \text{ V}; R_s = 0.0316 \Omega$
- (1) $T_j = 125 \text{ }^\circ\text{C}$; typical values
 - (2) $T_j = 125 \text{ }^\circ\text{C}$; maximum values
 - (3) $T_j = 25 \text{ }^\circ\text{C}$; maximum values

Fig. 7. On-state current as a function of on-state voltage

TO-220 Mechanical Drawing

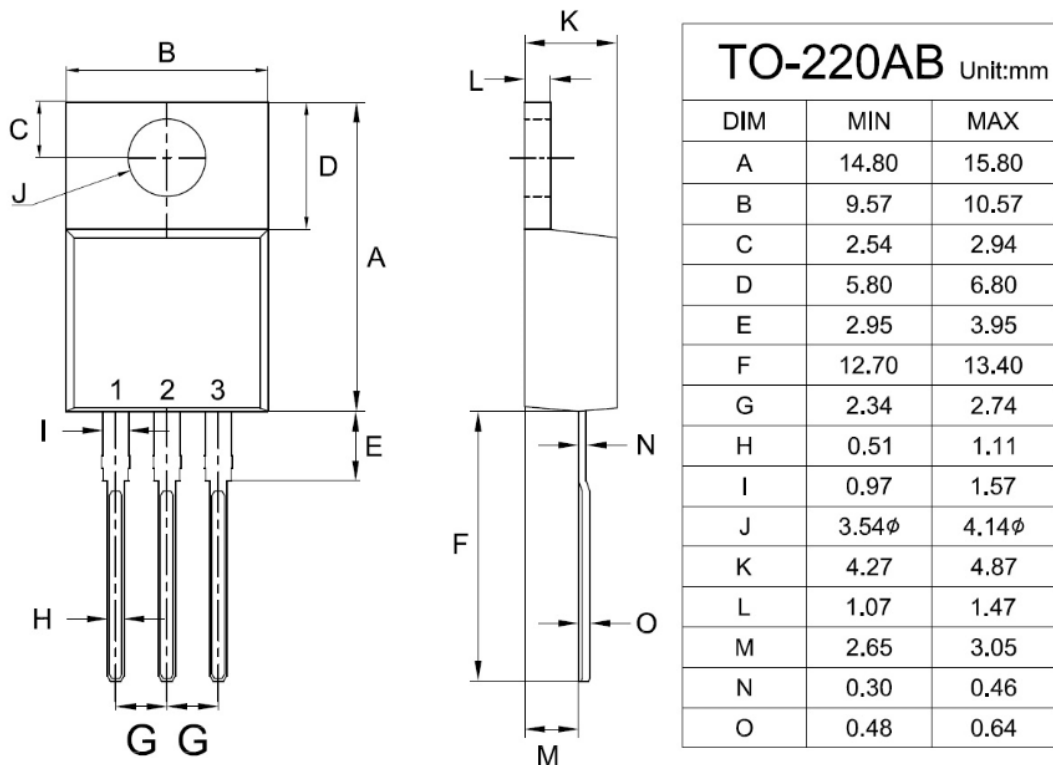

ITO-220 Mechanical Drawing

