

RECTIFIER DIODE

AUS603

Repetitive voltage up to	400 V
Mean forward current	12522 A
Surge current	88 kA

FINAL SPECIFICATION

May 17 - Issue: 4

Symbol	Characteristic	Conditions	T _j [°C]	Value	Unit
BLOCKING					
V _{RRM}	Repetitive peak reverse voltage		175	400	V
V _{RSM}	Non-repetitive peak reverse voltage		175	500	V
I _{RRM}	Repetitive peak reverse current	V=VRRM	175	75	mA
CONDUCTING					
I _{F(AV)}	Mean forward current	180° sin, 50 Hz, Th=85°C, double side cooled		12522	A
I _{F(AV)}	Mean forward current	180° sin, 50 Hz, Tc=55°C, double side cooled		24699	A
I _{FSM}	Surge forward current	Sine wave, 10 ms without reverse voltage	175	88	kA
I ² t	I ² t			38720 x 10 ³	A ² s
V _{FM}	Forward voltage	Forward current = 10000 A	25	0,92	V
V _{F(TO)}	Threshold voltage		175	0,79	V
r _F	Forward slope resistance		175	0,025	mohm
SWITCHING					
t _{rr}	Reverse recovery time		175		μs
Q _{rr}	Reverse recovery charge				μC
I _{rr}	Peak reverse recovery current				A
MOUNTING					
R _{th(j-c)}	Thermal impedance, DC	Junction to case, double side cooled		4,6	°C/kW
R _{th(c-h)}	Thermal impedance	Case to heatsink, double side cooled		2,5	°C/kW
T _j	Operating junction temperature			-30 / 175	°C
F	Mounting force			35.0 / 65.0	kN
	Mass			160	g
ORDERING INFORMATION : AUS603 S 04 standard specification <input type="checkbox"/> <input type="checkbox"/> VRRM/100					

DISSIPATION CHARACTERISTICS

SQUARE WAVE

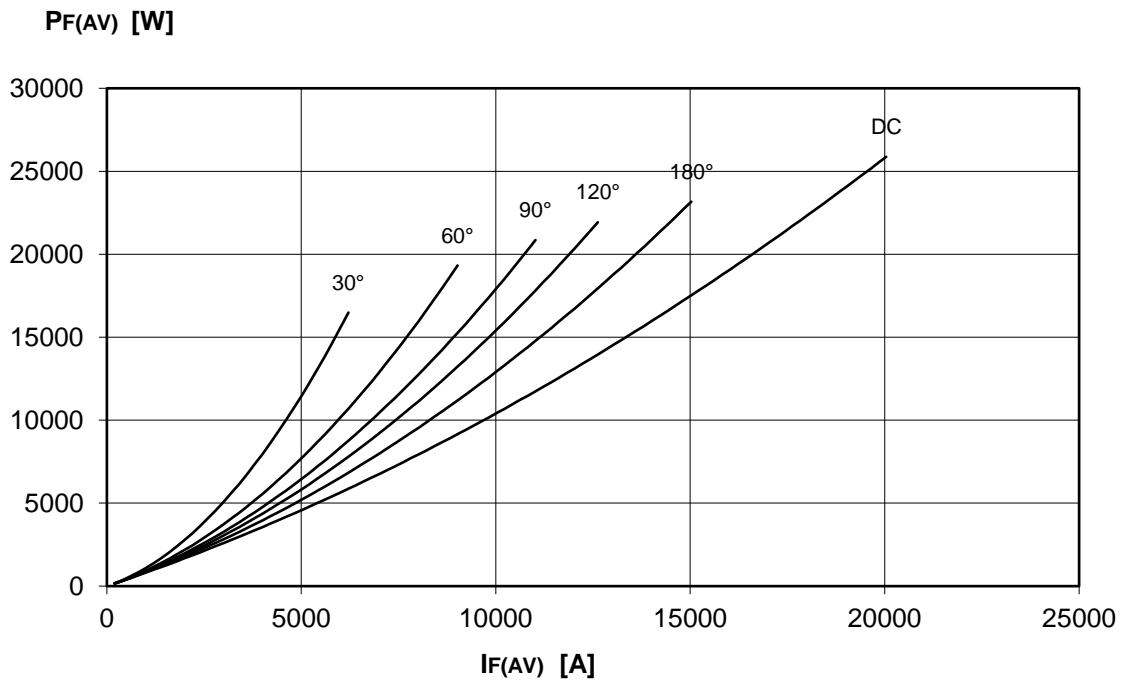
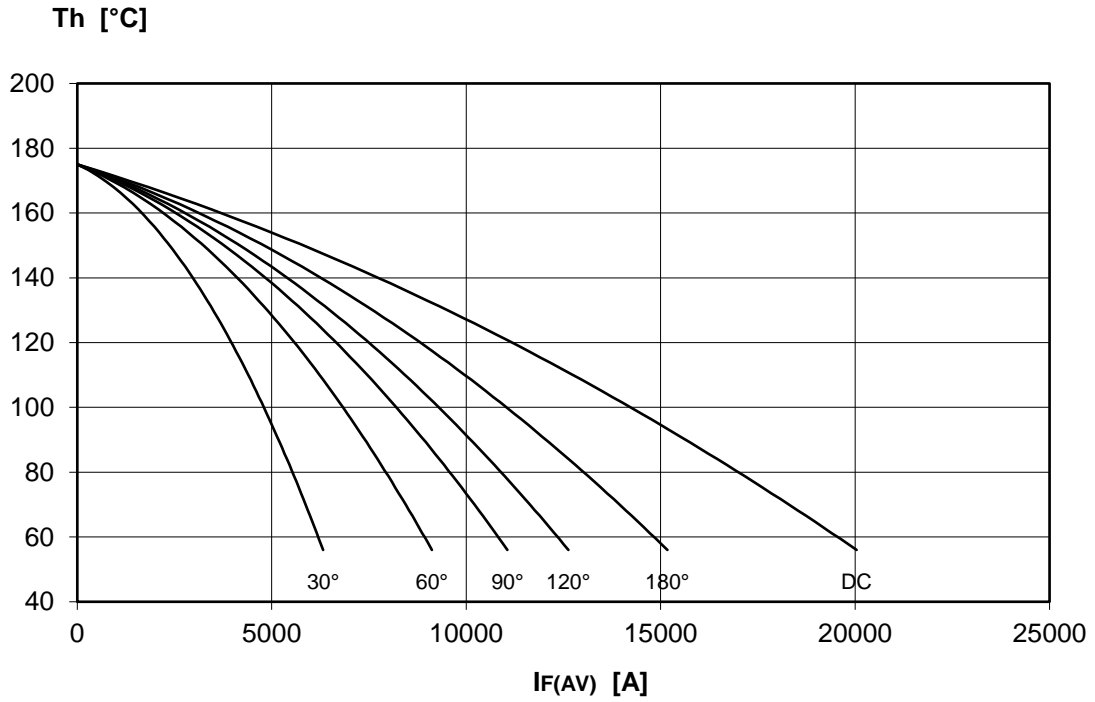

DISSIPATION CHARACTERISTICS

SINE WAVE

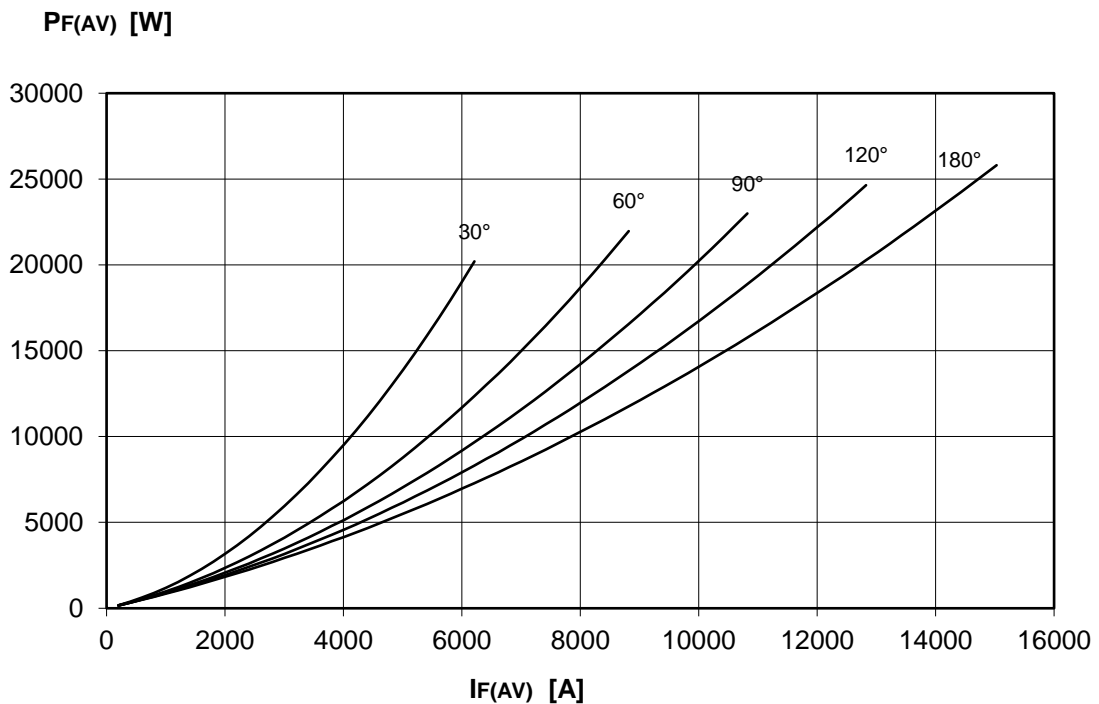
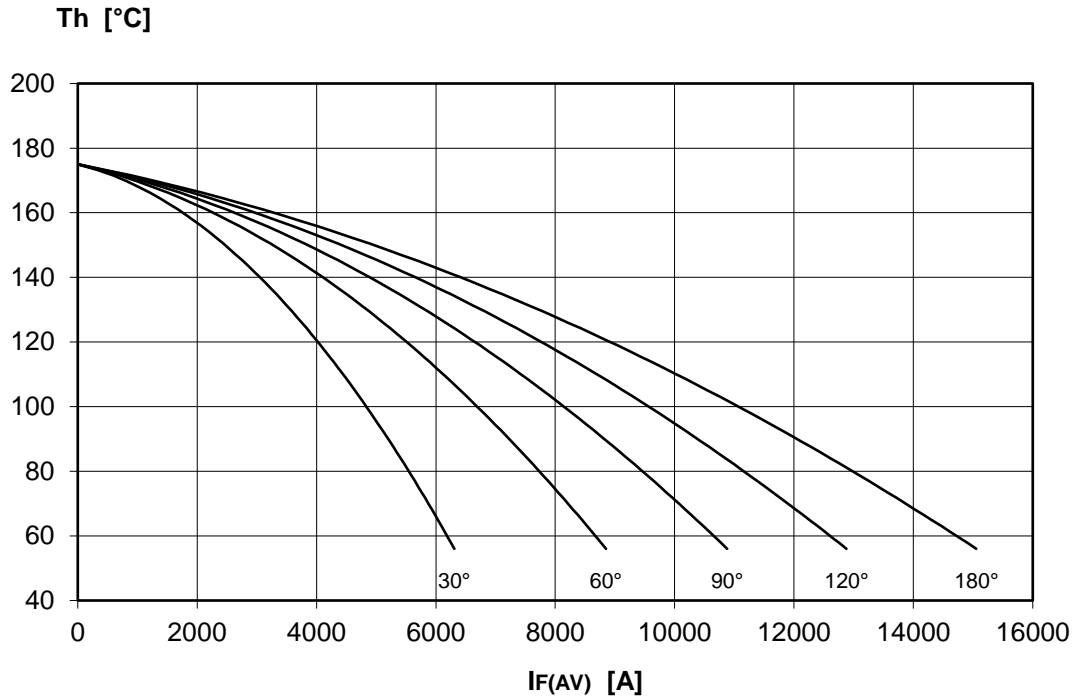

FORWARD CHARACTERISTIC
T_j = 175 °C

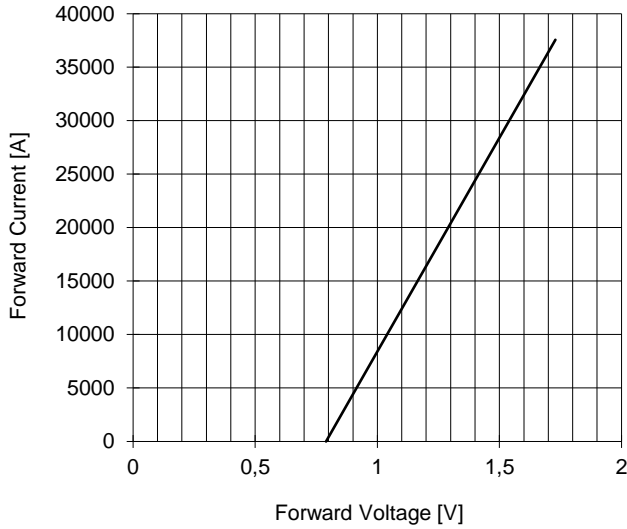

SURGE CHARACTERISTIC
T_j = 175 °C

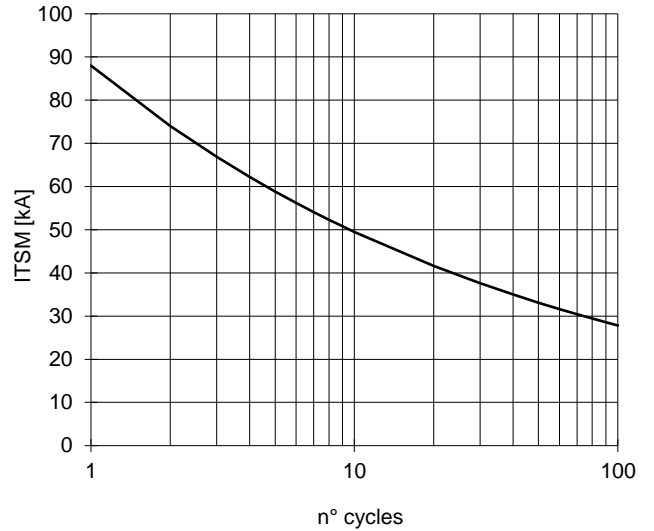

TRANSIENT THERMAL IMPEDANCE
DOUBLE SIDE COOLED

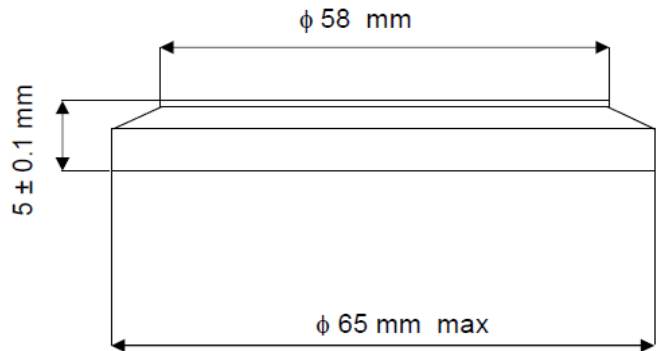
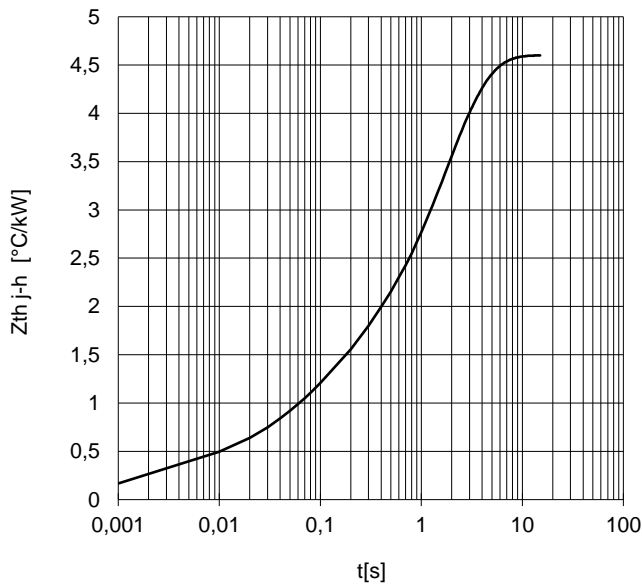

All the characteristics given in this data sheet are guaranteed only with uniform clamping force, cleaned and lubricated heatsink, surfaces with flatness < .03 mm and roughness < 2 μm.
In the interest of product improvement POSEICO SpA reserves the right to change any data given in this data sheet at any time without previous notice.
If not stated otherwise the maximum value of ratings (symbols over shaded background) and characteristics is reported.

Distributed by

