



PRODUCT DATASHEET

Mira series

last update 26/6/2015

DETAILS

Product Number	CN13146_MIRA-WW
Family	Mira
Type	Pack
Color	black
Diameter	34,2 mm
Height	16,15 mm
Style	round
Optic Material	PC
Holder Material	
Fastening	screw
Status	production ready
ROHS Compliant	Yes
Date Updated	26/06/2015



OPTICAL PROPERTIES

LED	Viewing Angle	Light Beam	Efficiency	cd/lm	Connector
V10 Gen6	56 deg	Very Wide	78 %	0.920	-
CXA/B 15xx	57 deg	Very Wide	-	0.820	-
Duris P10	sim: 52	Very Wide	sim: 83 %	sim: 1.100	-

Relative intensity of CN13146_MIRA-WW_(V10)

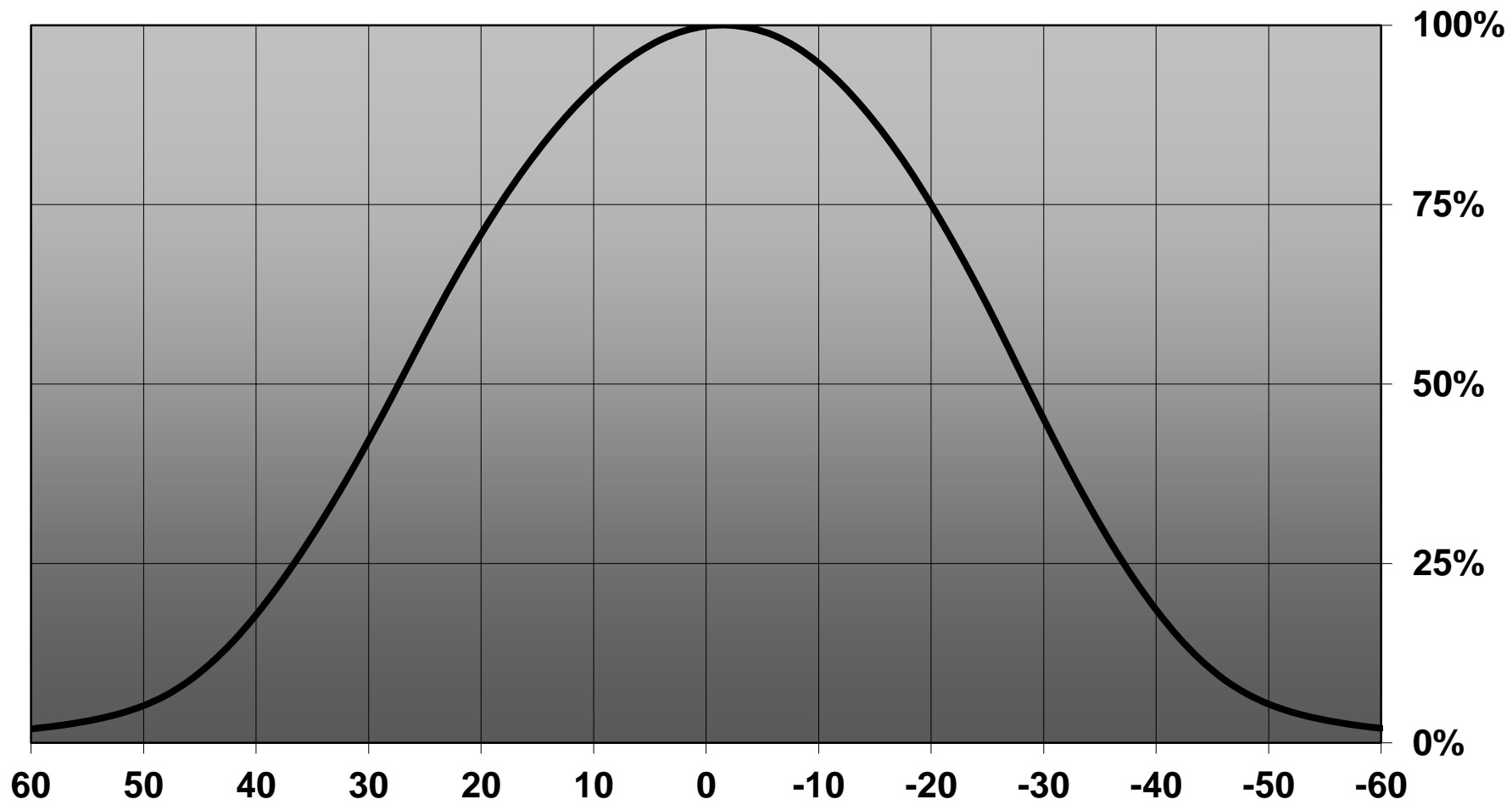

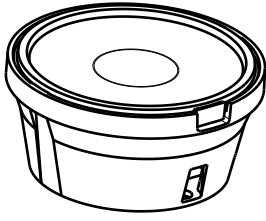

Isometric view

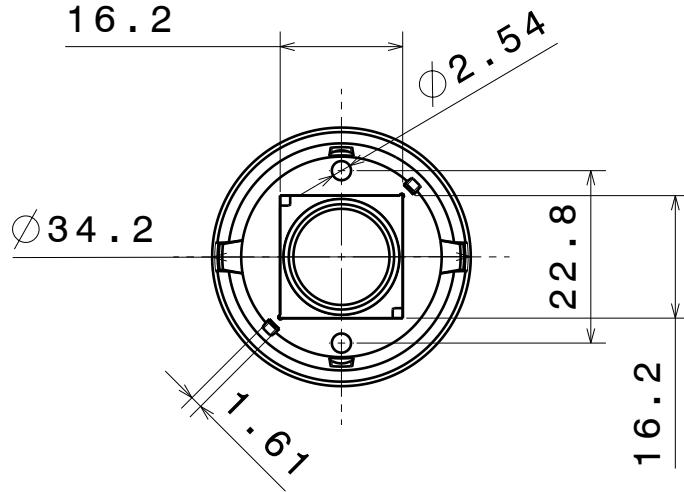

Bottom view

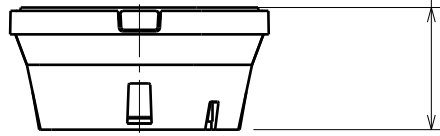

Front view

Materials:

- LENS: PC
- HOLDER: PC, black
- TAPE: PU foam

Tolerances if not otherwise shown
 According to DIN ISO 2768-1
 Linear measures:
 Up to 30mm class M, otherwise class C.
 According to DIN ISO 2768-2
 Form and position: class L



Ledil Oy
 Salorankatu 10
 FIN 24240 SALO
 Finland

THIRD ANGLE PROJECTION:

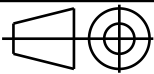

DRAWING TITLE

Datasheet MIRA assembly

This drawing is the property of LEDiL Oy. It may not be reproduced, copied or communicated without a written agreement with LEDiL Oy."

16.11.2012

SIZE PART NUMBER

A4

-

SCALE 1:1 WEIGHT

SHEET 1/1

Luminaire: Ledil Oy CN13146_MIRA-WW_(Duris_P10)_SIMULATED
Lamps: 1 x Osram Duris P10

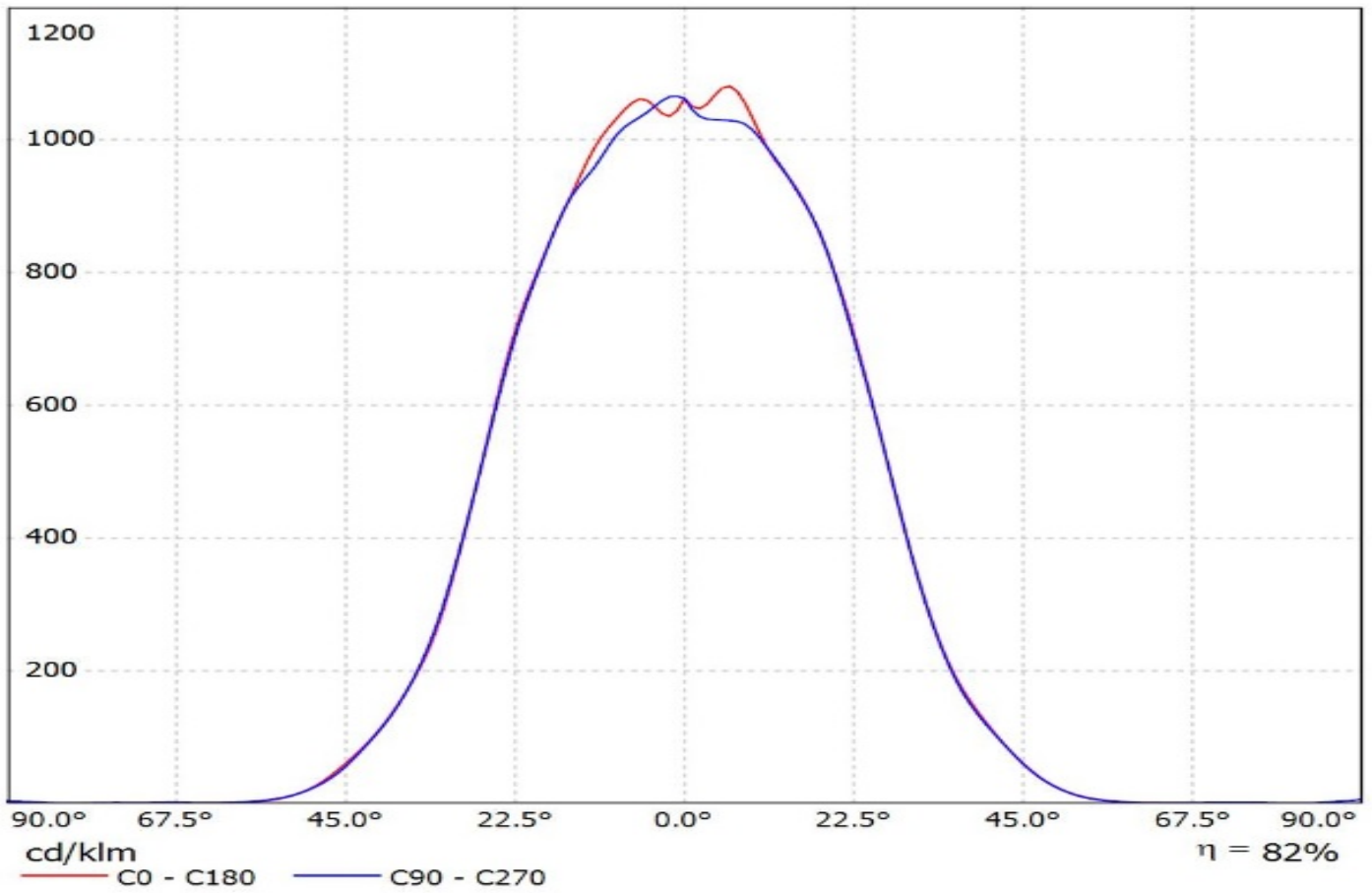

Luminaire: Ledil Oy CN13146_MIRA-WW_(Duris_P10)_SIMULATED
Lamps: 1 x Osram Duris P10

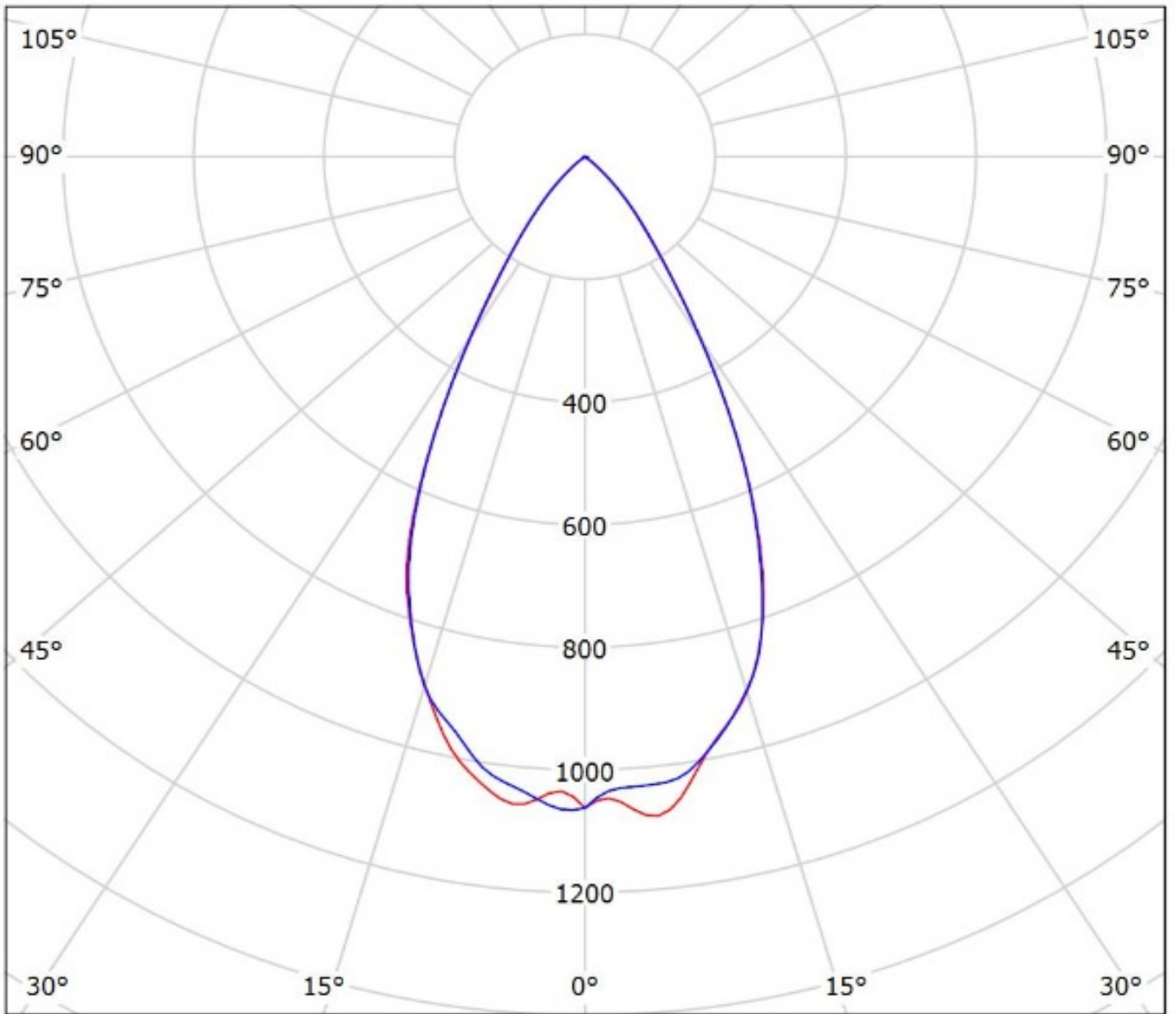

cd/klm

— C0 - C180 — C90 - C270

$\eta = 82\%$

NOTE: The typical divergence will be changed by different color, chip size and chip position tolerance. The typical total divergence is the full angle measured where the luminous intensity is half of the peak value.

GENERAL INFORMATION

- Product series especially designed & optimized for series of LEDs.
- Special care taken to make light distribution as uniform as possible.

Note! Due to use of high power COB's with this product, special attention to proper thermal design is highly recommended. LEDiL has no liability for direct, indirect or consecutive damages arising from the LEDiL products being used outside of the recommended temperature range.