

VFS60B-T8AK01024

VFS60

MOTOR FEEDBACK SYSTEMS ROTARY INCREMENTAL

SICK
Sensor Intelligence.



Illustration may differ



Ordering information

Type	Part no.
VFS60B-T8AK01024	1036022

Other models and accessories → www.sick.com/VFS60

Detailed technical data

Performance

Number of lines per revolution	1,024
Reference signal, number	1
Reference signal, position	90° electric, logically gated with A and B
Error limits	± 0.05°
Measuring step deviation	± 0.01°
Maximum initialisation time	≤ 40 ms

Interfaces

Communication interface	TTL/RS422
--------------------------------	-----------

Electrical data

Supply voltage range	4.5 V ... 5.5 V
Operating power consumption (no load)	≤ 40 mA ¹⁾
Maximum output frequency	≤ 600 kHz
Maximum load current	≤ 30 mA

¹⁾ Without load.

Mechanical data

Shaft material	Plastic
Flange type / stator coupling	Standard
Dimensions	See dimensional drawing
Weight	0.2 kg
Moment of inertia of the rotor	40 gcm ²
Operating speed	12,000 min ⁻¹ ¹⁾
Angular acceleration	≤ 500,000 rad/s ²
Operating torque	0.6 Ncm (+20 °C)
Start up torque	0.8 Ncm (+20 °C)

¹⁾ Self-warming 3.3 K/1,000 1/min, when applying note working temperature range.

²⁾ The universal cable outlet is positioned in such a way, that it is possible to lay the cable in a radial or axial direction without kinking it.

Permissible shaft movement, radial static/dynamic	± 0.3 mm / ± 0.1 mm
Permissible shaft movement, axial static/dynamic	± 0.5 mm / ± 0.2 mm
Life of ball bearings	3.0 x 10 ⁹ revolutions
Connection type	Cable, 8-wire, radial, 1.5 m ²⁾

¹⁾ Self-warming 3.3 K/1,000 1/min, when applying note working temperature range.

²⁾ The universal cable outlet is positioned in such a way, that it is possible to lay the cable in a radial or axial direction without kinking it.

Ambient data

Operating temperature range	-30 °C ... +100 °C
Storage temperature range	-40 °C ... +100 °C, without package
Relative humidity/condensation	90 %, condensation of the optical scanning not permitted
Resistance to shocks	70 g, 6 ms (according to EN 60068-2-27)
Frequency range of resistance to vibrations	30 g, 10 Hz ... 2,000 Hz (according to EN 60068-2-6)
EMC	According to EN 61000-6-2 and EN 61000-6-4
Enclosure rating	IP65, shaft side (according to IEC 60529) IP65, housing side, cable outlet (according to IEC 60529)

Classifications

ECl@ss 5.0	27270501
ECl@ss 5.1.4	27270501
ECl@ss 6.0	27270590
ECl@ss 6.2	27270590
ECl@ss 7.0	27270501
ECl@ss 8.0	27270501
ECl@ss 8.1	27270501
ECl@ss 9.0	27270501
ETIM 5.0	EC001486
ETIM 6.0	EC001486
UNSPSC 16.0901	41112113

Dimensional drawing (Dimensions in mm (inch))

Through hollow shaft, plastic, cable outlet

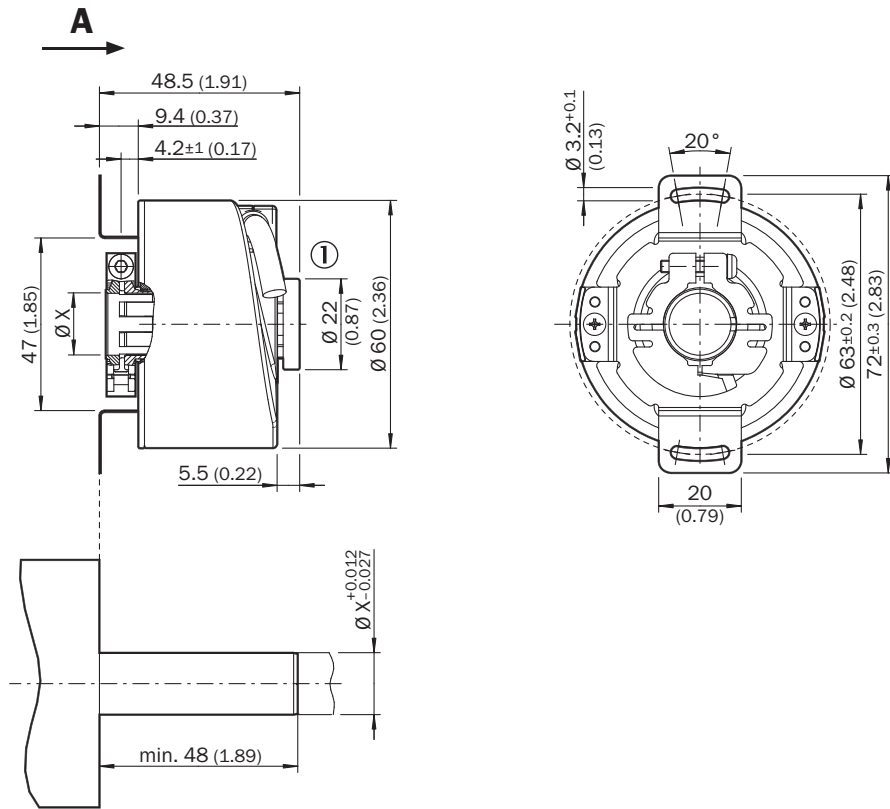

General tolerances according to DIN ISO 2768-mk

Diagram

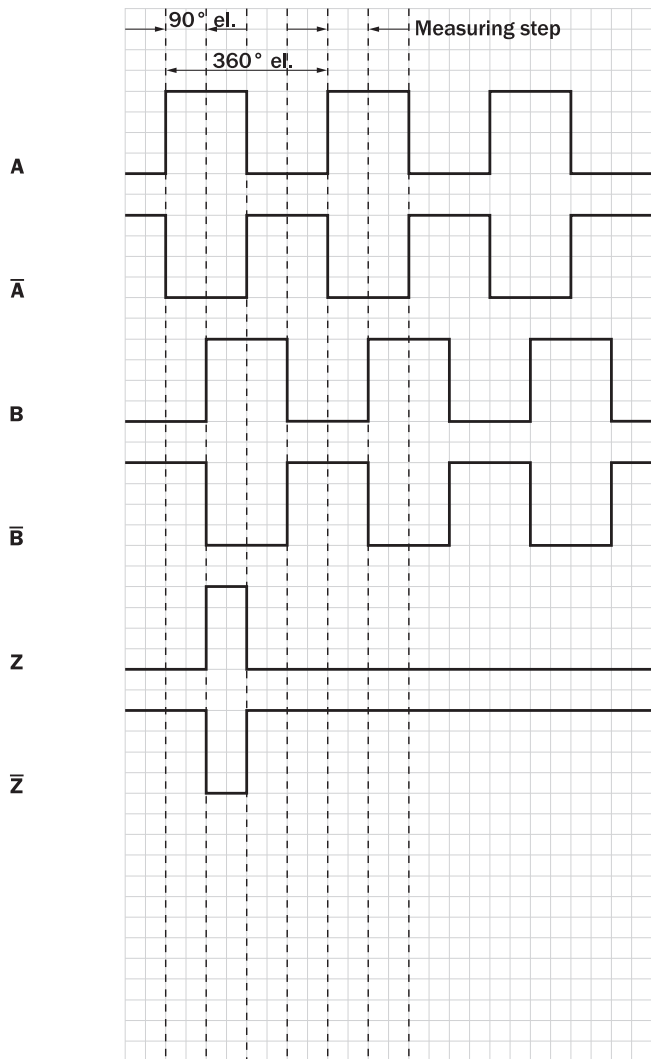

Recommended accessories

Other models and accessories → www.sick.com/VFS60

	Brief description	Type	Part no.
Flanges			
	One-sided stator coupling, slot, slot radius 33 mm to 48.5 mm, slot width 5.1 mm	BEF-DS01DFS/VFS	2047428
	One-sided stator coupling, slot, slot radius 32.25 mm to 141.75 mm, slot width 5.1 mm	BEF-DS02DFS/VFS	2047430
	One-sided stator coupling, slot, slot radius 33 mm to 211.9 mm, slot width 5.1 mm	BEF-DS03DFS/VFS	2047431

	Brief description	Type	Part no.
Plug connectors and cables			
	Head A: cable Head B: cable Cable: SSI, drag chain use, PUR, halogen-free, shielded	LTG-2308-MWENC	6027529
	Head A: cable Head B: cable Cable: SSI, PUR, shielded	LTG-2411-MW	6027530
	Head A: cable Head B: cable Cable: SSI, drag chain use, PUR, halogen-free, shielded	LTG-2512-MW	6027531
	Head A: cable Head B: cable Cable: SSI, drag chain use, PUR, halogen-free, shielded	LTG-2612-MW	6028516
	Head A: female connector, JST, 8-pin, straight Head B: cable Cable: Incremental, drag chain use, PUR, halogen-free, shielded, 3 m	DOL-0J08-G03MAA3	2046875
	Head A: female connector, JST, 8-pin, straight Head B: cable Cable: Incremental, SSI, drag chain use, PUR, halogen-free, shielded, 5 m	DOL-0J08-G05MAA3	2046876
	Head A: female connector, JST, 8-pin, straight Head B: cable Cable: Incremental, SSI, drag chain use, PUR, halogen-free, shielded, 0.5 m	DOL-0J08-G0M5AA3	2046873
	Head A: female connector, JST, 8-pin, straight Head B: cable Cable: Incremental, SSI, drag chain use, PUR, halogen-free, shielded, 10 m	DOL-0J08-G10MAA3	2046877
	Head A: female connector, JST, 8-pin, straight Head B: cable Cable: Incremental, drag chain use, PUR, halogen-free, shielded, 1.5 m	DOL-0J08-G1M5AA3	2046874
	Head A: female connector, M23, 12-pin, straight Head B: cable Cable: Incremental, PUR, shielded, 2 m	DOL-2312-G02MLA3	2030682
	Head A: female connector, M23, 12-pin, straight Head B: cable Cable: Incremental, drag chain use, PUR, shielded, 3 m	DOL-2312-G03MMA3	2029213
	Head A: female connector, M23, 12-pin, straight Head B: cable Cable: Incremental, drag chain use, PUR, shielded, 5 m	DOL-2312-G05MMA3	2029214
	Head A: female connector, M23, 12-pin, straight Head B: cable Cable: Incremental, PUR, shielded, 7 m	DOL-2312-G07MLA3	2030685
	Head A: female connector, M23, 12-pin, straight Head B: cable Cable: Incremental, PUR, shielded, 10 m	DOL-2312-G10MLA3	2030688
	Head A: female connector, M23, 12-pin, straight Head B: cable Cable: Incremental, drag chain use, PUR, shielded, 10 m	DOL-2312-G10MMA3	2029215
	Head A: female connector, M23, 12-pin, straight Head B: cable Cable: Incremental, PUR, shielded, 15 m	DOL-2312-G15MLA3	2030692
	Head A: female connector, M23, 12-pin, straight Head B: cable Cable: Incremental, drag chain use, PUR, shielded, 1.5 m	DOL-2312-G1M5MA3	2029212
	Head A: female connector, M23, 12-pin, straight Head B: cable Cable: Incremental, PUR, shielded, 20 m	DOL-2312-G20MLA3	2030695

	Brief description	Type	Part no.
	Head A: female connector, M23, 12-pin, straight Head B: cable Cable: Incremental, drag chain use, PUR, shielded, 20 m	DOL-2312-G20MMA3	2029216
	Head A: female connector, M23, 12-pin, straight Head B: cable Cable: Incremental, PUR, shielded, 25 m	DOL-2312-G25MLA3	2030699
	Head A: female connector, M23, 12-pin, straight Head B: cable Cable: Incremental, PUR, shielded, 30 m	DOL-2312-G30MLA3	2030702
	Head A: female connector, M23, 12-pin, straight Head B: cable Cable: Incremental, drag chain use, PUR, shielded, 30 m	DOL-2312-G30MMA3	2029217
	Head A: male connector, M12, 5-pin, angled, B-coded Head B: cable Cable: PROFIBUS DP, drag chain use, twisted pair, PUR, shielded, 5 m	STL-1205-W05MQ	6041426
	Head A: male connector, M12, 5-pin, angled, B-coded Head B: cable Cable: PROFIBUS DP, drag chain use, twisted pair, PUR, shielded, 10 m	STL-1205-W10MQ	6041427
	Head A: female connector, JST, 8-pin, straight Head B: male connector, M23, 17-pin, straight Cable: Incremental, unshielded, 1 m	DSL-2317-G01MJB7	2071332
	Head A: female connector, terminal box, 8-pin, straight Head B: male connector, M23, 17-pin, straight Cable: Incremental, unshielded, 1 m	DSL-2317-G01MJC7	2071331
	Head A: female connector, JST, 8-pin, straight Head B: male connector, M23, 12-pin, straight Cable: Incremental, drag chain use, PUR, halogen-free, shielded, 1 m	STL-2312-G01MAA3	2061622
	Head A: female connector, JST, 8-pin, straight Head B: male connector, M23, 12-pin, straight Cable: Incremental, drag chain use, PUR, halogen-free, shielded, 2 m	STL-2312-G02MAA3	2061504
	Head A: female connector, JST, 8-pin, straight Head B: male connector, M23, 12-pin, straight Cable: Incremental, drag chain use, PUR, halogen-free, shielded, 0.35 m	STL-2312-GM35AA3	2061621
	Head A: female connector, M23, 12-pin, straight Head B: - Cable: HIPERFACE®, SSI, Incremental, shielded	DOS-2312-G	6027538
	Head A: female connector, M23, 12-pin, angled Head B: - Cable: HIPERFACE®, SSI, Incremental, shielded	DOS-2312-W01	2072580
	Head A: male connector, M23, 12-pin, straight Head B: - Cable: HIPERFACE®, SSI, Incremental, RS-422, shielded	STE-2312-G	6027537
Programming and configuration tools			
	SVip® LAN programming tool for all motor feedback systems	PGT-11-S LAN	1057324
	SVip® WLAN programming tool for all motor feedback systems	PGT-11-S WLAN	1067474

SICK AT A GLANCE

SICK is one of the leading manufacturers of intelligent sensors and sensor solutions for industrial applications. A unique range of products and services creates the perfect basis for controlling processes securely and efficiently, protecting individuals from accidents and preventing damage to the environment.

We have extensive experience in a wide range of industries and understand their processes and requirements. With intelligent sensors, we can deliver exactly what our customers need. In application centers in Europe, Asia and North America, system solutions are tested and optimized in accordance with customer specifications. All this makes us a reliable supplier and development partner.

Comprehensive services complete our offering: SICK LifeTime Services provide support throughout the machine life cycle and ensure safety and productivity.

For us, that is “Sensor Intelligence.”

WORLDWIDE PRESENCE:

Contacts and other locations –www.sick.com