

## Product Summary

$BV_{DSS}$	$R_{DS(ON)}$ Max	$I_D$ $T_A = +25^\circ C$
30V	69m $\Omega$ @ $V_{GS} = 8V$	3.2A
	80m $\Omega$ @ $V_{GS} = 4.5V$	3.0A

## Description

This new generation MOSFET is designed to minimize the footprint in handheld and mobile application. It can be used to replace many small signals MOSFET with as really small footprint.

## Applications

- Battery Management
- Load Switch
- Battery Protection
- Handheld and Mobile Application

## Features and Benefits

- Low  $Q_g$  &  $Q_{gd}$
- Small Footprint
- Low Profile 0.30mm Height
- Totally Lead-Free & Fully RoHS Compliant (Notes 1 & 2)**
- Halogen and Antimony Free. "Green" Device (Note 3)**

## Mechanical Data

- Case: X2-DSN1006-3
- Terminal Connections: See Diagram Below
- Terminals: Finish – Matte Tin Annealed Over Copper Pillar  $\text{E3}$

X2-DSN1006-3

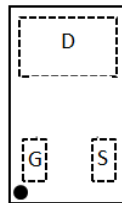

Top View

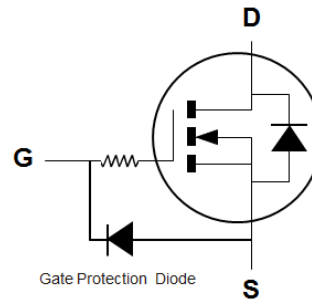

Equivalent Circuit

## Ordering Information (Note 4)

Part Number	Case	Packaging
DMN3110LCP3-7	X2-DSN1006-3	3000/Tape & Reel

- Notes:
- No purposely added lead. Fully EU Directive 2002/95/EC (RoHS) & 2011/65/EU (RoHS 2) compliant.
  - See [http://www.diodes.com/quality/lead\\_free.html](http://www.diodes.com/quality/lead_free.html) for more information about Diodes Incorporated's definitions of Halogen- and Antimony-free, "Green" and Lead-free.
  - Halogen- and Antimony-free "Green" products are defined as those which contain <900ppm bromine, <900ppm chlorine (<1500ppm total Br + Cl) and <1000ppm antimony compounds.
  - For packaging details, go to our website at <http://www.diodes.com/products/packages.html>.

## Marking Information



C = Product Type Marking Code  
 YM = Date Code Marking  
 Y or  $\bar{Y}$  = Year (ex: D = 2016)  
 M or  $\bar{M}$  = Month (ex: 9 = September)

### Date Code Key

Year	2014	2015	2016	2017	2018	2019	2020	2021	2022	2023	2024	2025
Code	B	C	D	E	F	G	H	I	J	K	L	M

Month	Jan	Feb	Mar	Apr	May	Jun	Jul	Aug	Sep	Oct	Nov	Dec
Code	1	2	3	4	5	6	7	8	9	O	N	D

**Maximum Ratings** (@T<sub>A</sub> = +25°C, unless otherwise specified.)

Characteristic			Symbol	Value	Unit
Drain-Source Voltage			V <sub>DSS</sub>	30	V
Gate-Source Voltage			V <sub>GSS</sub>	12	V
Continuous Drain Current (Note 5) V <sub>GS</sub> = 8V	Steady State	T <sub>A</sub> = +25°C	I <sub>D</sub>	3.2	A
		T <sub>A</sub> = +70°C		2.5	
Continuous Drain Current (Note 5) V <sub>GS</sub> = 4.5V	Steady State	T <sub>A</sub> = +25°C	I <sub>D</sub>	3.0	A
		T <sub>A</sub> = +70°C		2.4	
Pulsed Drain Current (Note 6)			I <sub>DM</sub>	15	A

**Thermal Characteristics**

Characteristic	Symbol	Value	Unit
Power Dissipation (Note 7)	P <sub>D</sub>	0.5	W
Thermal Resistance, Junction to Ambient @T <sub>A</sub> = +25°C (Note 7)	R <sub>θJA</sub>	250	°C/W
Power Dissipation (Note 5)	P <sub>D</sub>	1.38	W
Thermal Resistance, Junction to Ambient @T <sub>A</sub> = +25°C (Note 5)	R <sub>θJA</sub>	90	°C/W
Operating and Storage Temperature Range	T <sub>J</sub> , T <sub>STG</sub>	-55 to +150	°C

**Electrical Characteristics** (@T<sub>A</sub> = +25°C, unless otherwise specified.)

Characteristic	Symbol	Min	Typ	Max	Unit	Test Condition
<b>OFF CHARACTERISTICS (Note 8)</b>						
Drain-Source Breakdown Voltage	BV <sub>DSS</sub>	30	—	—	V	V <sub>GS</sub> = 0V, I <sub>D</sub> = 250μA
Zero Gate Voltage Drain Current T <sub>J</sub> = +25°C	I <sub>DSS</sub>	—	—	100	nA	V <sub>DS</sub> = 24V, V <sub>GS</sub> = 0V
Gate-Source Leakage	I <sub>GSS</sub>	—	—	50	nA	V <sub>GS</sub> = 10V, V <sub>DS</sub> = 0V
<b>ON CHARACTERISTICS (Note 8)</b>						
Gate Threshold Voltage	V <sub>GS(TH)</sub>	0.65	0.8	1.1	V	V <sub>DS</sub> = V <sub>GS</sub> , I <sub>D</sub> = 250μA
Static Drain-Source On-Resistance	R <sub>DS(ON)</sub>	—	52	69	mΩ	V <sub>GS</sub> = 8V, I <sub>D</sub> = 0.5A
		—	59	80		V <sub>GS</sub> = 4.5V, I <sub>D</sub> = 0.5A
		—	76	110		V <sub>GS</sub> = 2.5V, I <sub>D</sub> = 0.5A
		—	110	160		V <sub>GS</sub> = 1.8V, I <sub>D</sub> = 0.5A
Forward Transfer Admittance	Y <sub>fs</sub>	—	3.3	—	S	V <sub>DS</sub> = 15V, I <sub>D</sub> = 0.5A
Diode Forward Voltage	V <sub>SD</sub>	—	0.7	0.9	V	V <sub>GS</sub> = 0V, I <sub>S</sub> = 0.5A
Reverse Recovery Charge	Q <sub>RR</sub>	—	1.7	—	nC	V <sub>DD</sub> = 15V, I <sub>F</sub> = 0.5A,
Reverse Recovery Time	t <sub>RR</sub>	—	5.2	—	ns	di/dt = 300A/μs
<b>DYNAMIC CHARACTERISTICS (Note 9)</b>						
Input Capacitance	C <sub>iss</sub>	—	110	150	pF	V <sub>DS</sub> = 15V, V <sub>GS</sub> = 0V, f = 1.0MHz
Output Capacitance	C <sub>oss</sub>	—	71	99		
Reverse Transfer Capacitance	C <sub>rss</sub>	—	4.3	10		
Series Gate Resistance	R <sub>g</sub>	—	21	—	Ω	f=1MHz, V <sub>GS</sub> =0V, V <sub>DS</sub> =0V
Total Gate Charge	Q <sub>g</sub>	—	1,090	1,520	pC	V <sub>GS</sub> = 4.5V, V <sub>DS</sub> = 15V, I <sub>D</sub> = 0.5A
Gate-Source Charge	Q <sub>gs</sub>	—	130	—		
Gate-Drain Charge	Q <sub>gd</sub>	—	130	—		
Gate Charge at V <sub>TH</sub>	Q <sub>g(TH)</sub>	—	110	—		
Turn-On Delay Time	t <sub>D(ON)</sub>	—	4.8	7	ns	V <sub>DS</sub> = 15V, V <sub>GS</sub> = 4.5V, R <sub>g</sub> = 2Ω, I <sub>D</sub> = 0.5A
Turn-On Rise Time	t <sub>R</sub>	—	2.8	—		
Turn-Off Delay Time	t <sub>D(OFF)</sub>	—	16.5	20		
Turn-Off Fall Time	t <sub>F</sub>	—	9.5	—		

- Notes:
- Device mounted on FR-4 material with 1inch<sup>2</sup> (6.45cm<sup>2</sup>), 2oz. (0.071mm thick) Cu.
  - Repetitive rating, pulse width limited by junction temperature.
  - Device mounted on FR-4 PCB with minimum recommended pad layout, single sided.
  - Short duration pulse test used to minimize self-heating effect.
  - Guaranteed by design. Not subject to production testing.

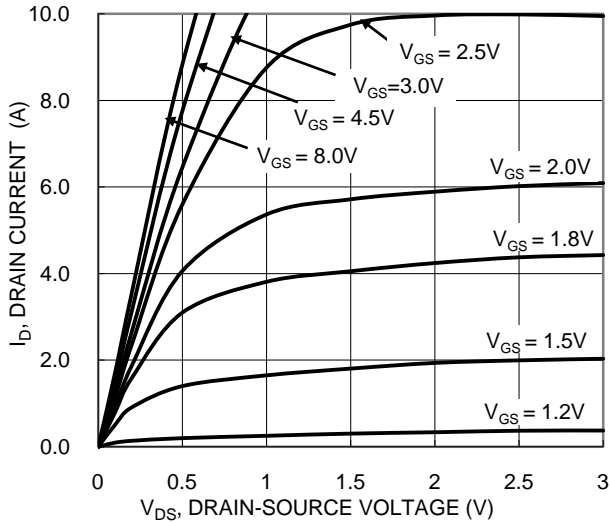

Figure 1. Typical Output Characteristic

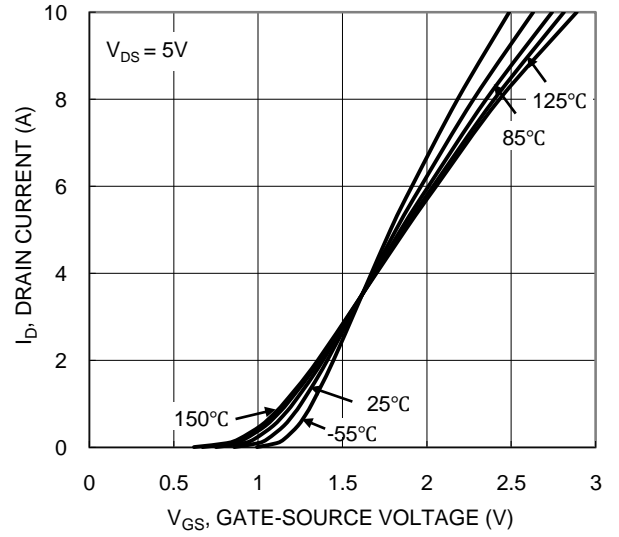

Figure 2. Typical Transfer Characteristic

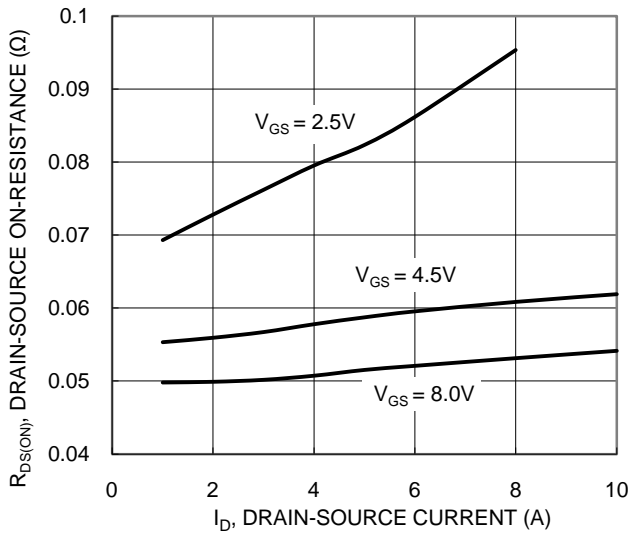

Figure 3. Typical On-Resistance vs. Drain Current and Gate Voltage

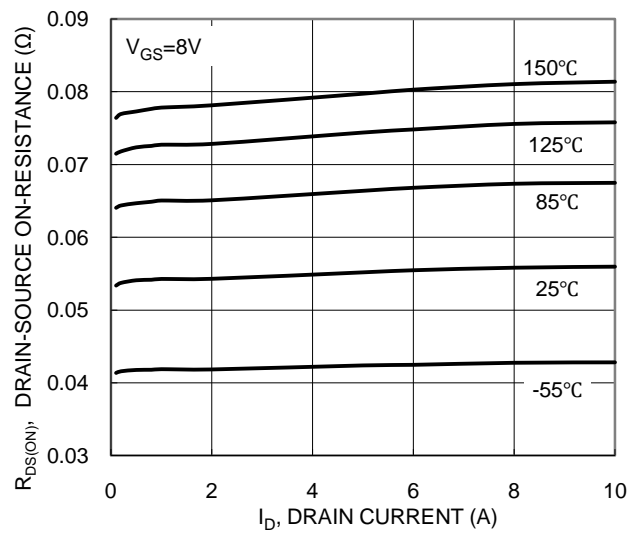

Figure 4. Typical On-Resistance vs. Drain Current and Junction Temperature

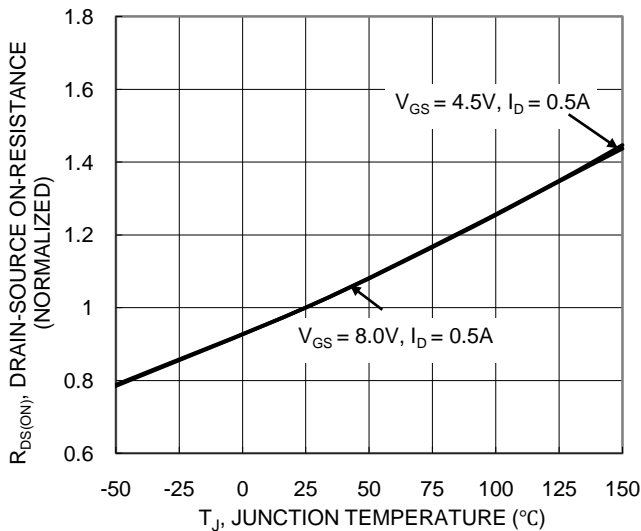

Figure 5. On-Resistance Variation with Junction Temperature

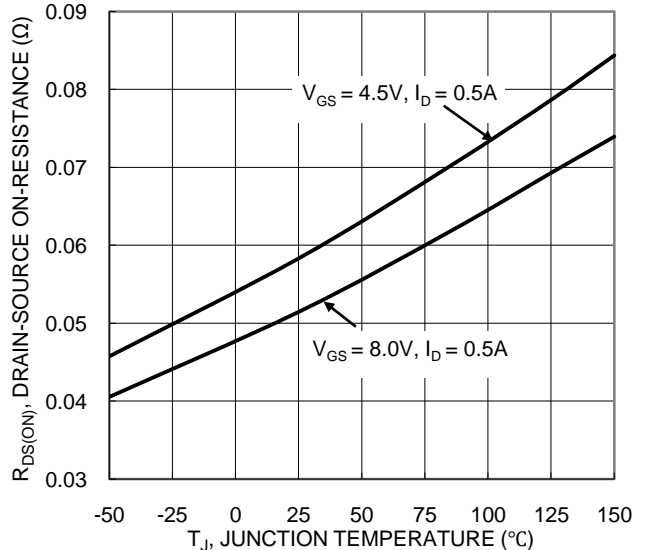

Figure 6. On-Resistance Variation with Junction Temperature

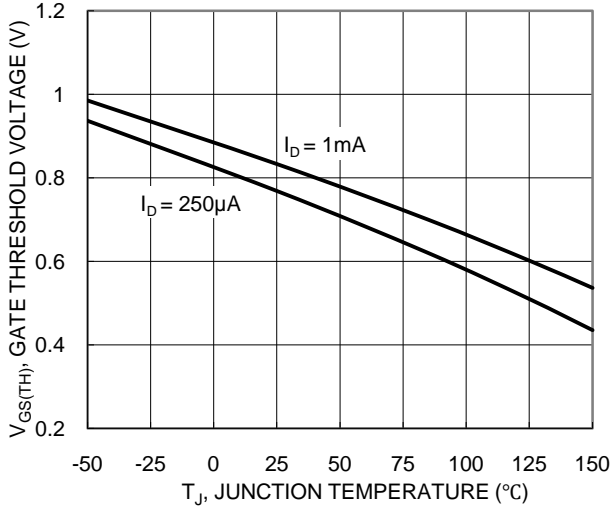

Figure 7. Gate Threshold Variation vs. Junction Temperature

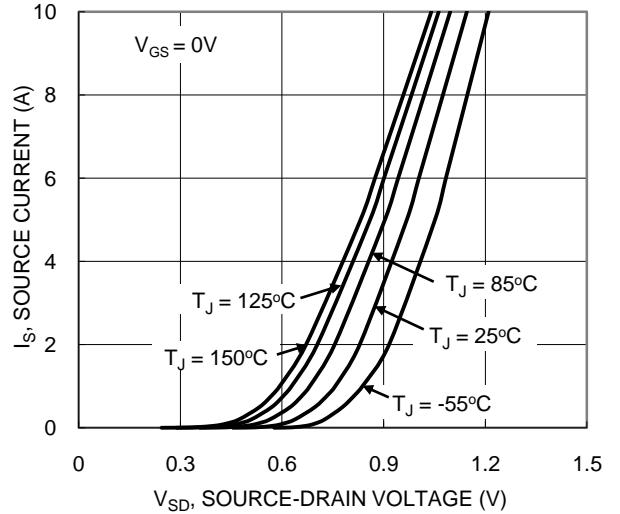

Figure 8. Diode Forward Voltage vs. Current

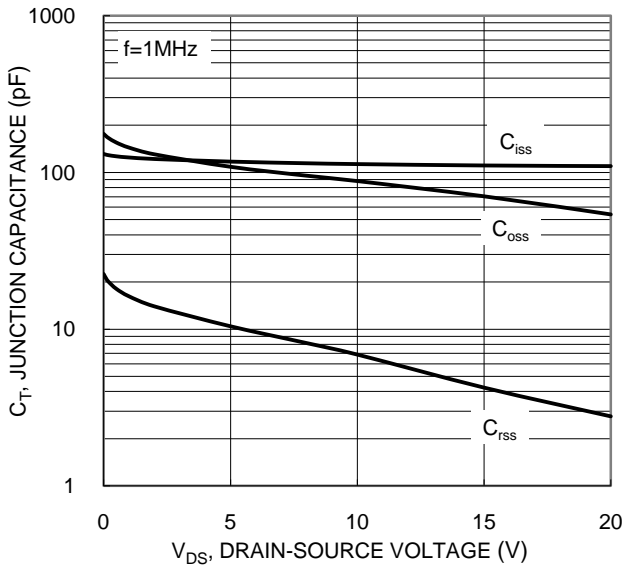

Figure 9. Typical Junction Capacitance

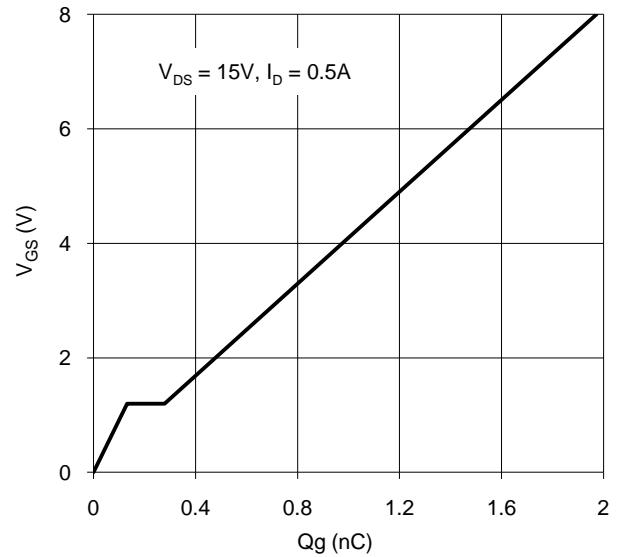

Figure 10. Gate Charge

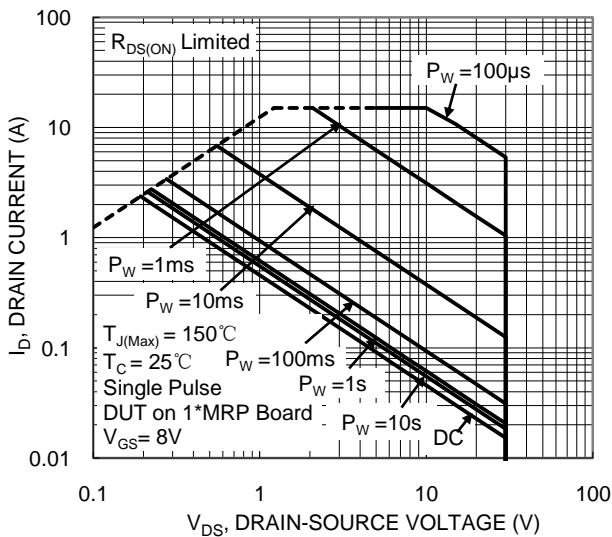

Figure 11. SOA, Safe Operation Area

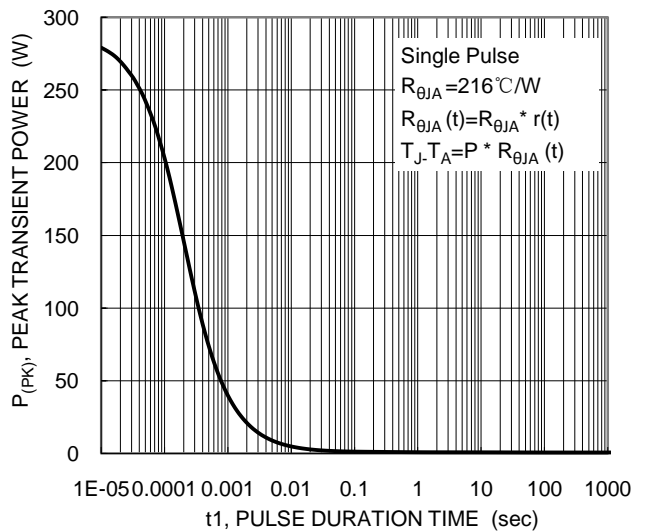

Figure 12. Single Pulse Maximum Power Dissipation

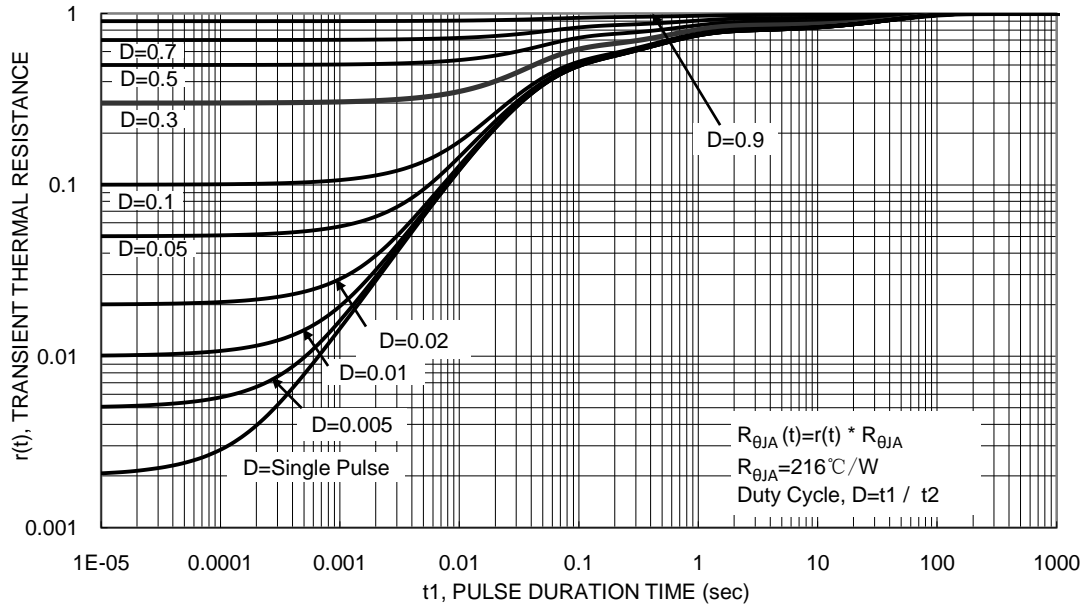
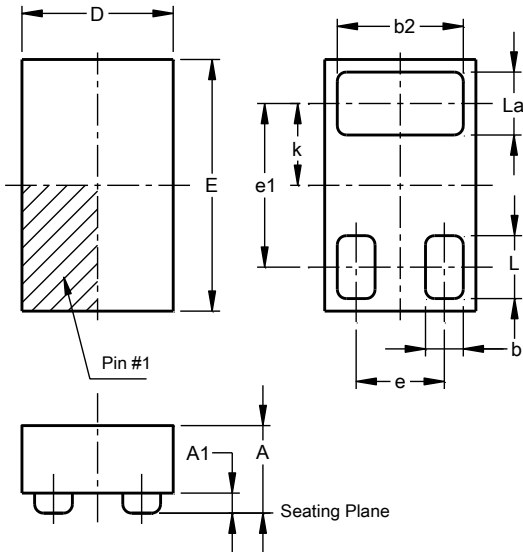

Figure 13. Transient Thermal Resistance

## Package Outline Dimensions

Please see <http://www.diodes.com/package-outlines.html> for the latest version.

### X2-DSN1006-3



X2-DSN1006-3			
Dim	Min	Max	Typ
A	--	0.348	0.32
A1	--	--	0.08
b	0.14	0.16	0.15
b2	0.49	0.51	0.50
D	0.56	0.64	0.60
E	0.96	1.04	1.00
e	--	--	0.35
e1	--	--	0.65
k	--	--	0.325
L	0.21	0.29	0.25
La	0.21	0.29	0.25
All Dimensions in mm			

## Suggested Pad Layout

Please see <http://www.diodes.com/package-outlines.html> for the latest version.

### X2-DSN1006-3

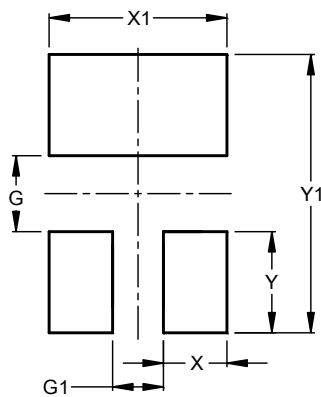

Dimensions	Value (in mm)
G	0.30
G1	0.20
X	0.25
X1	0.70
Y	0.40
Y1	1.10

**IMPORTANT NOTICE**

DIODES INCORPORATED MAKES NO WARRANTY OF ANY KIND, EXPRESS OR IMPLIED, WITH REGARDS TO THIS DOCUMENT, INCLUDING, BUT NOT LIMITED TO, THE IMPLIED WARRANTIES OF MERCHANTABILITY AND FITNESS FOR A PARTICULAR PURPOSE (AND THEIR EQUIVALENTS UNDER THE LAWS OF ANY JURISDICTION).

Diodes Incorporated and its subsidiaries reserve the right to make modifications, enhancements, improvements, corrections or other changes without further notice to this document and any product described herein. Diodes Incorporated does not assume any liability arising out of the application or use of this document or any product described herein; neither does Diodes Incorporated convey any license under its patent or trademark rights, nor the rights of others. Any Customer or user of this document or products described herein in such applications shall assume all risks of such use and will agree to hold Diodes Incorporated and all the companies whose products are represented on Diodes Incorporated website, harmless against all damages.

Diodes Incorporated does not warrant or accept any liability whatsoever in respect of any products purchased through unauthorized sales channel. Should Customers purchase or use Diodes Incorporated products for any unintended or unauthorized application, Customers shall indemnify and hold Diodes Incorporated and its representatives harmless against all claims, damages, expenses, and attorney fees arising out of, directly or indirectly, any claim of personal injury or death associated with such unintended or unauthorized application.

Products described herein may be covered by one or more United States, international or foreign patents pending. Product names and markings noted herein may also be covered by one or more United States, international or foreign trademarks.

This document is written in English but may be translated into multiple languages for reference. Only the English version of this document is the final and determinative format released by Diodes Incorporated.

**LIFE SUPPORT**

Diodes Incorporated products are specifically not authorized for use as critical components in life support devices or systems without the express written approval of the Chief Executive Officer of Diodes Incorporated. As used herein:

A. Life support devices or systems are devices or systems which:

1. are intended to implant into the body, or
2. support or sustain life and whose failure to perform when properly used in accordance with instructions for use provided in the labeling can be reasonably expected to result in significant injury to the user.

B. A critical component is any component in a life support device or system whose failure to perform can be reasonably expected to cause the failure of the life support device or to affect its safety or effectiveness.

Customers represent that they have all necessary expertise in the safety and regulatory ramifications of their life support devices or systems, and acknowledge and agree that they are solely responsible for all legal, regulatory and safety-related requirements concerning their products and any use of Diodes Incorporated products in such safety-critical, life support devices or systems, notwithstanding any devices- or systems-related information or support that may be provided by Diodes Incorporated. Further, Customers must fully indemnify Diodes Incorporated and its representatives against any damages arising out of the use of Diodes Incorporated products in such safety-critical, life support devices or systems.

Copyright © 2017, Diodes Incorporated

[www.diodes.com](http://www.diodes.com)