

Surface Mount Ceramic Chip Antennas for 2.4 GHz

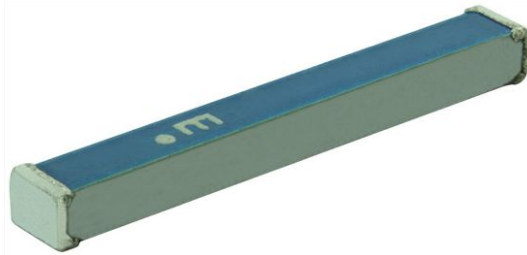

VJ5103W240GXCMT chip antenna

The VJ5103W240 series are small form-factor, high-performance chip-antennas designed to be used in wireless, bluetooth and ISM band 2.4 GHz.

The VJ5103W240 series present an excellent performance (max. gain 3 dBi) with a low profile needed in most wireless applications.

DESCRIPTION

The VJ5103W240GXCMT ceramic chip antenna is a small form-factor, high-performance, chip-antenna designed for operation at 2.4 GHz. It allows manufacturers to design high quality products that do not bear the penalty of a large external antenna, and is designed to be assembled onto a PC board using a standard reflow process.

FEATURES

- Small outline (8.0 mm x 1.05 mm x 0.8 mm)
- 50 Ω unbalanced tuning interface
- Omnidirectional
- Assembled onto a PCB in the standard reflow process
- Low profile for thin type terminal
- High stability in temperature / humidity changes
- High mechanical strength
- Wide operating temperature range (- 40 °C to + 85 °C)
- Material categorization: For definitions of compliance please see www.vishay.com/doc?99912

RoHS
COMPLIANT
HALOGEN
FREE

APPLICATIONS

- Bluetooth
- Wireless LAN
- ISM band 2.4 GHz wireless applications

ELECTRICAL SPECIFICATIONS

Operating temperature: - 40 °C to + 85 °C

Frequency range (transmission / reception): 2450 MHz \pm 50 MHz

Note

- Electrical characteristics at + 25 °C unless otherwise specified.

QUICK REFERENCE DATA

SERIES	FREQUENCY (MHz)	MAX. GAIN (dBi)	AVERAGE GAIN (dBi)	BANDWIDTH (- 10 dB) (MHz)	BANDWIDTH (- 3 dB) (MHz)
VJ5103W240GXCMT	2450	+ 3.0	- 0.60	250	570

CHIP ANTENNA PERFORMANCE

NOMINAL FREQUENCY (MHz)	NOMINAL IMPEDANCE (Ω)	2.45 GHz PEAK GAIN (dBi)	2.45 GHz AVERAGE GAIN (dBi)	2.45 GHz REFLECTED POWER LOSS	2.45 GHz INSERTION POWER LOSS	- 3 dB BANDWIDTH 2.45 GHz	- 3 dB REFLECTED POWER LOSS	- 10 dB BANDWIDTH 2.45 GHz	- 10 dB REFLECTED POWER LOSS
2450	50	- 0.60	+ 3.0	< - 15 dB	< 4 %	570	50 %	250	10 %
				< 3.2 %	< 0.14 dB		3 dB		0.46 dB

FOOTPRINT, MECHANICAL, AND PCB DIMENSIONS

The antenna footprint and mechanical dimensions are presented in figure 7. Optimal tuning is adjusted according to PCB layout.

FIGURE	SYMBOL	DIMENSION (mm)
	L	8.0 ± 0.20
	W	1.05 ± 0.20
	T	0.80 ± 0.10
	A	0.30 ± 0.10

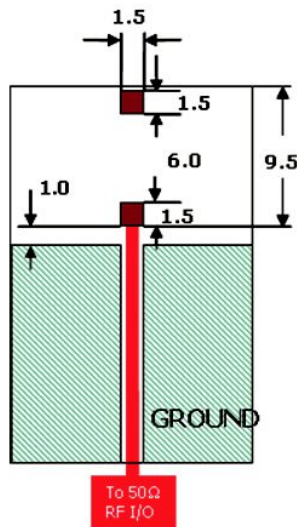

Unit : mm

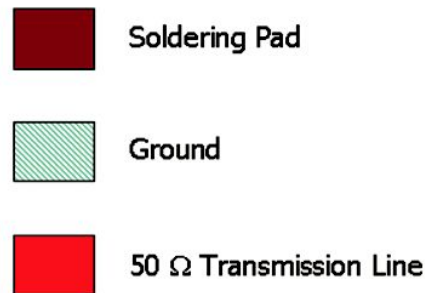

Top View

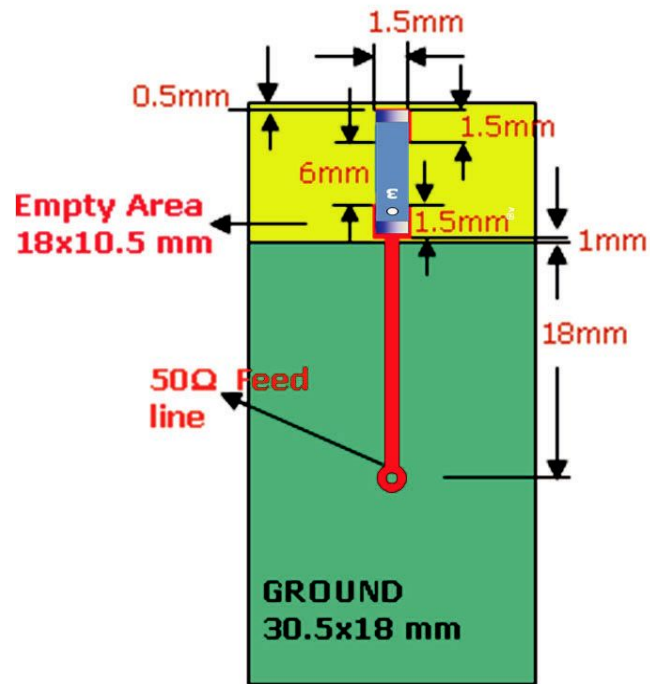

Antenna on Test Board (FRA thickness 0.8 mm)

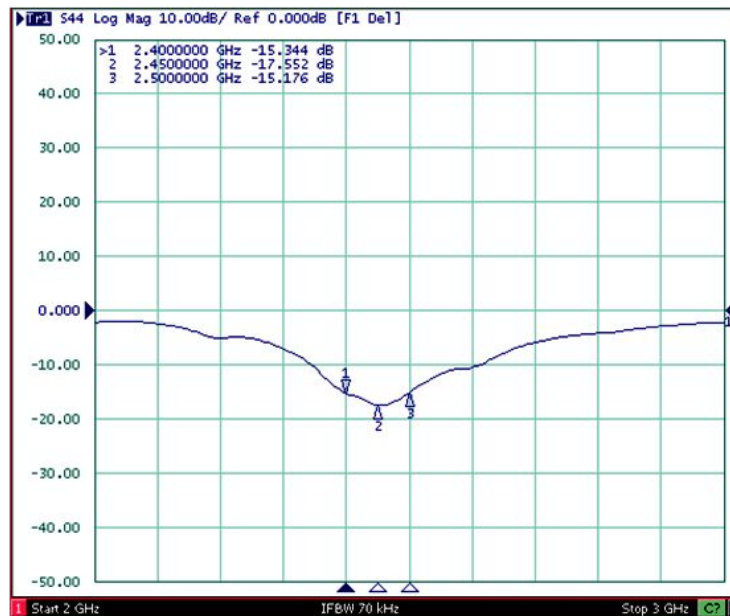

Antenna S11 on Test Board

RADIATION PATTERN

Radiation pattern and gain were dependent on measurement board design. The specification of VJ5103W240GXCMT antenna was measured based on the PCB size and installation position as shown in the below figure test board.

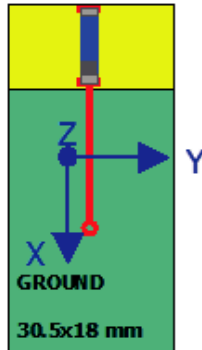

	VERTICAL	HORIZONTAL
Y - Z Plane Average Gain = 1.19 dBi	Peak Gain = 3.03 dBi, Average Gain = 0.71 dBi 	Peak Gain = - 1.37 dBi, Average Gain = - 8.6 dBi
X - Z Plane Average Gain = - 2.91 dBi	Peak Gain = - 3.76 dBi, Average Gain = - 8.72 dBi 	Peak Gain = 0.25 dBi, Average Gain = - 4.24 dBi
X - Y Plane Average Gain = - 0.95 dBi	Peak Gain = - 0.76 dBi, Average Gain = - 5.81 dBi 	Peak Gain = 1.37 dBi, Average Gain = - 2.67 dBi

SOLDERING CONDITION

Typical examples of soldering processes that provide reliable joints without any damage are given in figure 2.

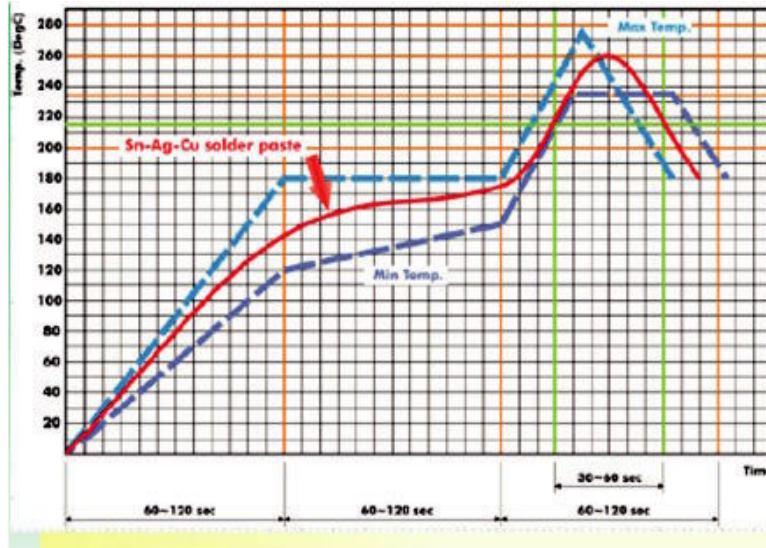
PLASTIC TAPE SPECIFICATIONS (Dimensions in mm)

A ₀	B ₀	ØD	T	W	E	F	P ₀	P ₁	P ₂
1.20 ± 0.10	8.20 ± 0.10	1.50 ± 0.10	1.00 ± 0.10	16.0 ± 0.10	1.75 ± 0.10	7.50 ± 0.10	4.00 ± 0.05	4.00 ± 0.10	2.00 ± 0.05

ORDERING INFORMATION	VISHAY MATERIAL	PACKAGING QUANTITY
VJ5103W240 Chip Antenna	VJ5103W240GXCMT	2000 pieces



Disclaimer

ALL PRODUCT, PRODUCT SPECIFICATIONS AND DATA ARE SUBJECT TO CHANGE WITHOUT NOTICE TO IMPROVE RELIABILITY, FUNCTION OR DESIGN OR OTHERWISE.

Vishay Intertechnology, Inc., its affiliates, agents, and employees, and all persons acting on its or their behalf (collectively, "Vishay"), disclaim any and all liability for any errors, inaccuracies or incompleteness contained in any datasheet or in any other disclosure relating to any product.

Vishay makes no warranty, representation or guarantee regarding the suitability of the products for any particular purpose or the continuing production of any product. To the maximum extent permitted by applicable law, Vishay disclaims (i) any and all liability arising out of the application or use of any product, (ii) any and all liability, including without limitation special, consequential or incidental damages, and (iii) any and all implied warranties, including warranties of fitness for particular purpose, non-infringement and merchantability.

Statements regarding the suitability of products for certain types of applications are based on Vishay's knowledge of typical requirements that are often placed on Vishay products in generic applications. Such statements are not binding statements about the suitability of products for a particular application. It is the customer's responsibility to validate that a particular product with the properties described in the product specification is suitable for use in a particular application. Parameters provided in datasheets and/or specifications may vary in different applications and performance may vary over time. All operating parameters, including typical parameters, must be validated for each customer application by the customer's technical experts. Product specifications do not expand or otherwise modify Vishay's terms and conditions of purchase, including but not limited to the warranty expressed therein.

Except as expressly indicated in writing, Vishay products are not designed for use in medical, life-saving, or life-sustaining applications or for any other application in which the failure of the Vishay product could result in personal injury or death. Customers using or selling Vishay products not expressly indicated for use in such applications do so at their own risk. Please contact authorized Vishay personnel to obtain written terms and conditions regarding products designed for such applications.

No license, express or implied, by estoppel or otherwise, to any intellectual property rights is granted by this document or by any conduct of Vishay. Product names and markings noted herein may be trademarks of their respective owners.

Material Category Policy

Vishay Intertechnology, Inc. hereby certifies that all its products that are identified as RoHS-Compliant fulfill the definitions and restrictions defined under Directive 2011/65/EU of The European Parliament and of the Council of June 8, 2011 on the restriction of the use of certain hazardous substances in electrical and electronic equipment (EEE) - recast, unless otherwise specified as non-compliant.

Please note that some Vishay documentation may still make reference to RoHS Directive 2002/95/EC. We confirm that all the products identified as being compliant to Directive 2002/95/EC conform to Directive 2011/65/EU.

Vishay Intertechnology, Inc. hereby certifies that all its products that are identified as Halogen-Free follow Halogen-Free requirements as per JEDEC JS709A standards. Please note that some Vishay documentation may still make reference to the IEC 61249-2-21 definition. We confirm that all the products identified as being compliant to IEC 61249-2-21 conform to JEDEC JS709A standards.