

30V(D-S) N-Channel Enhancement Mode Power MOS FET

**General Features**

- $V_{DS} = 30V, I_D = 5.8A$   
 $R_{DS(ON)} < 59m\Omega @ V_{GS}=2.5V$   
 $R_{DS(ON)} < 45m\Omega @ V_{GS}=4.5V$   
 $R_{DS(ON)} < 41m\Omega @ V_{GS}=10V$
- High power and current handing capability
- Lead free product is acquired
- Surface mount package



**Lead Free**

**Application**

- PWM applications
- Load switch
- Power management

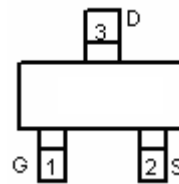

Marking and pin assignment

**PIN Configuration**



SOT-23 top view

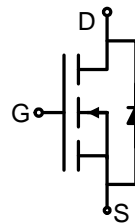

Schematic diagram

**Package Marking and Ordering Information**

Device Marking	Device	Device Package	Reel Size	Tape width	Quantity
	MSN3402A	SOT-23	Ø180mm	8 mm	3000 units

**Absolute Maximum Ratings ( $T_A=25^\circ C$  unless otherwise noted)**

Parameter	Symbol	Limit	Unit
Drain-Source Voltage	$V_{DS}$	30	V
Gate-Source Voltage	$V_{GS}$	$\pm 12$	V
Drain Current-Continuous	$I_D$	5.8	A
Drain Current-Pulsed <sup>(Note 1)</sup>	$I_{DM}$	30	A
Maximum Power Dissipation	$P_D$	1.4	W
Operating Junction and Storage Temperature Range	$T_J, T_{STG}$	-55 To 150	$^\circ C$

**Thermal Characteristic**

Thermal Resistance, Junction-to-Ambient <sup>(Note 2)</sup>	$R_{\theta JA}$	89	$^\circ C/W$
---	-----------------	----	--------------

**Electrical Characteristics (T<sub>A</sub>=25 °C unless otherwise noted)**

Parameter	Symbol	Condition	Min	Typ	Max	Unit
<b>Off Characteristics</b>						
Drain-Source Breakdown Voltage	BV <sub>DSS</sub>	V <sub>GS</sub> =0V, I <sub>D</sub> =250μA	30	33	-	V
Zero Gate Voltage Drain Current	I <sub>DSS</sub>	V <sub>DS</sub> =30V, V <sub>GS</sub> =0V	-	-	1	μA
Gate-Body Leakage Current	I <sub>GSS</sub>	V <sub>GS</sub> =±12V, V <sub>DS</sub> =0V	-	-	±100	nA
<b>On Characteristics</b> (Note 3)						
Gate Threshold Voltage	V <sub>GS(th)</sub>	V <sub>DS</sub> =V <sub>GS</sub> , I <sub>D</sub> =250μA	0.7	0.9	1.4	V
Drain-Source On-State Resistance	R <sub>DS(on)</sub>	V <sub>GS</sub> =2.5V, I <sub>D</sub> =4A	-	45	59	mΩ
		V <sub>GS</sub> =4.5V, I <sub>D</sub> =5A	-	31	45	mΩ
		V <sub>GS</sub> =10V, I <sub>D</sub> =5.8A	-	28	41	mΩ
Forward Transconductance	g <sub>FS</sub>	V <sub>DS</sub> =5V, I <sub>D</sub> =5A	10	-	-	S
<b>Dynamic Characteristics</b> (Note 4)						
Input Capacitance	C <sub>iss</sub>	V <sub>DS</sub> =15V, V <sub>GS</sub> =0V, F=1.0MHz	-	820	-	PF
Output Capacitance	C <sub>oss</sub>		-	99	-	PF
Reverse Transfer Capacitance	C <sub>rss</sub>		-	77	-	PF
<b>Switching Characteristics</b> (Note 4)						
Turn-on Delay Time	t <sub>d(on)</sub>	V <sub>DD</sub> =15V, R <sub>L</sub> =2.7Ω V <sub>GS</sub> =10V, R <sub>GEN</sub> =3Ω	-	3.3	-	nS
Turn-on Rise Time	t <sub>r</sub>		-	4.8	-	nS
Turn-Off Delay Time	t <sub>d(off)</sub>		-	26	-	nS
Turn-Off Fall Time	t <sub>f</sub>		-	4	-	nS
Total Gate Charge	Q <sub>g</sub>	V <sub>DS</sub> =15V, I <sub>D</sub> =5.8A, V <sub>GS</sub> =4.5V	-	9.5	-	nC
Gate-Source Charge	Q <sub>gs</sub>		-	1.5	-	nC
Gate-Drain Charge	Q <sub>gd</sub>		-	3	-	nC
<b>Drain-Source Diode Characteristics</b>						
Diode Forward Voltage (Note 3)	V <sub>SD</sub>	V <sub>GS</sub> =0V, I <sub>S</sub> =5.8A	-	-	1.2	V
Diode Forward Current (Note 2)	I <sub>S</sub>		-	-	5.8	A

**Notes:**

1. Repetitive Rating: Pulse width limited by maximum junction temperature.
2. Surface Mounted on FR4 Board, t ≤ 10 sec.
3. Pulse Test: Pulse Width ≤ 300μs, Duty Cycle ≤ 2%.
4. Guaranteed by design, not subject to production

Typical Electrical and Thermal Characteristics

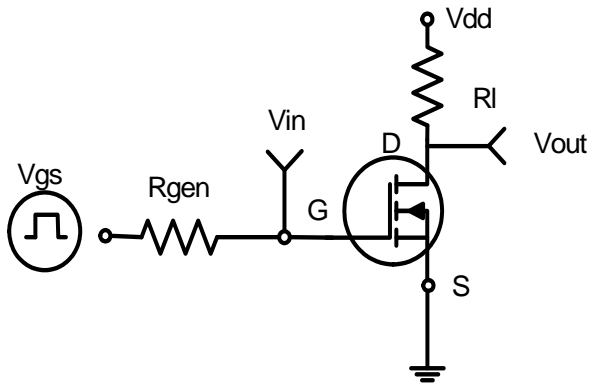

Figure 1: Switching Test Circuit

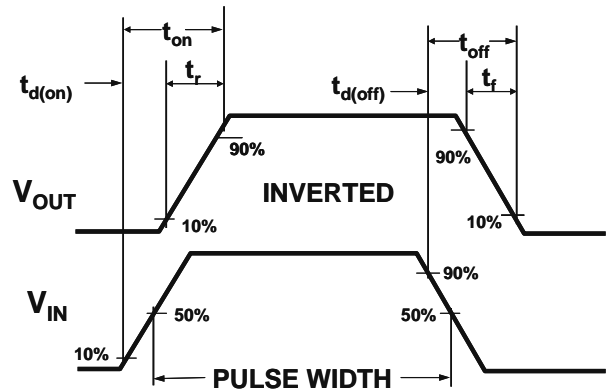

Figure 2: Switching Waveforms

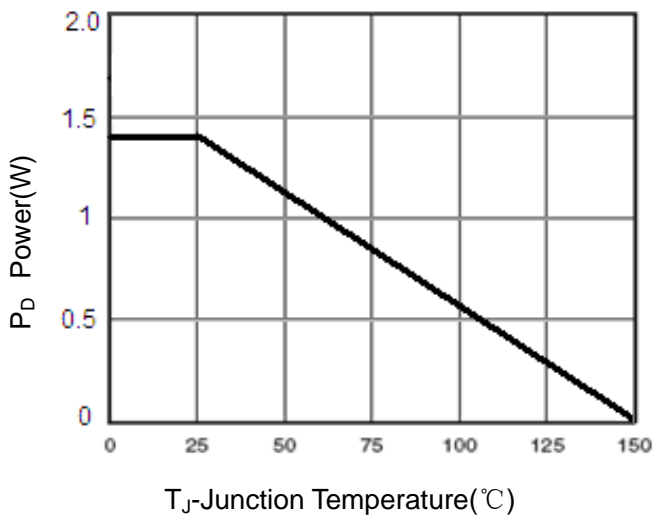

Figure 3 Power Dissipation

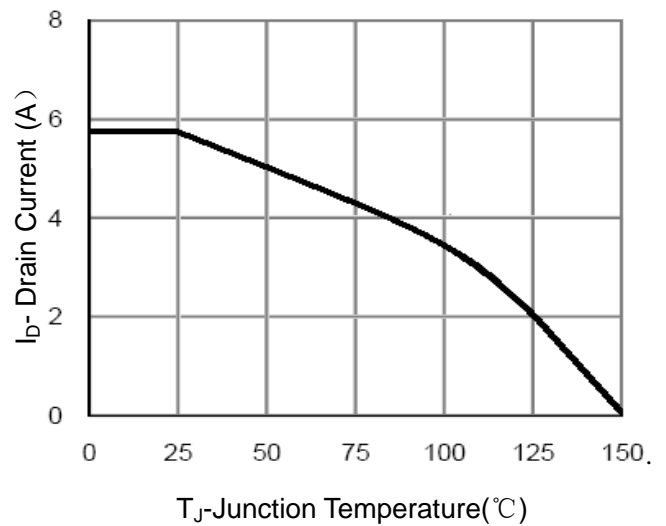

Figure 4 Drain Current

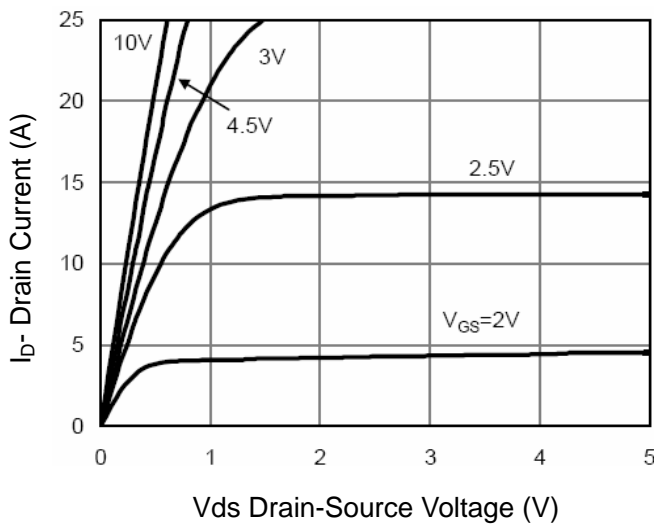

Figure 5 Output Characteristics

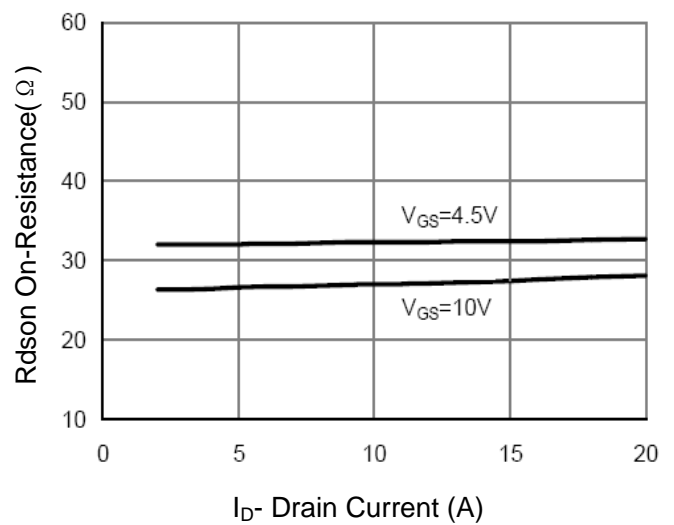

Figure 6 Drain-Source On-Resistance

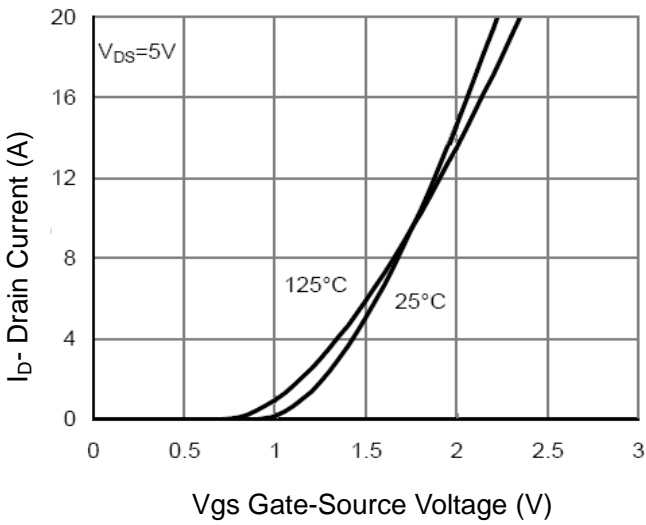

Figure 7 Transfer Characteristics

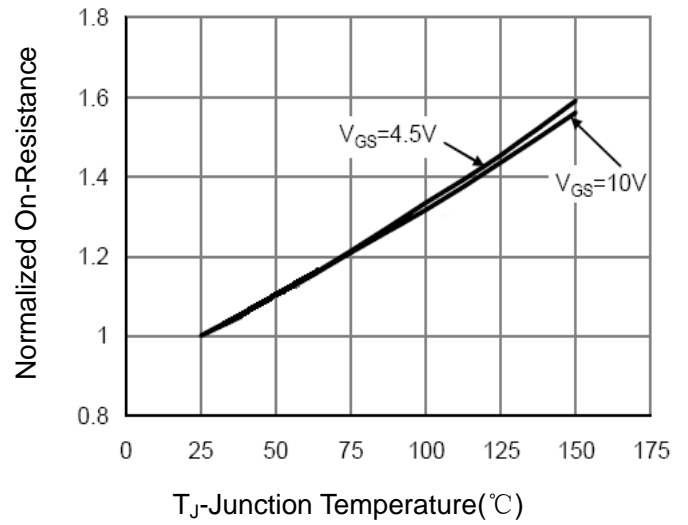

Figure 8 Drain-Source On-Resistance

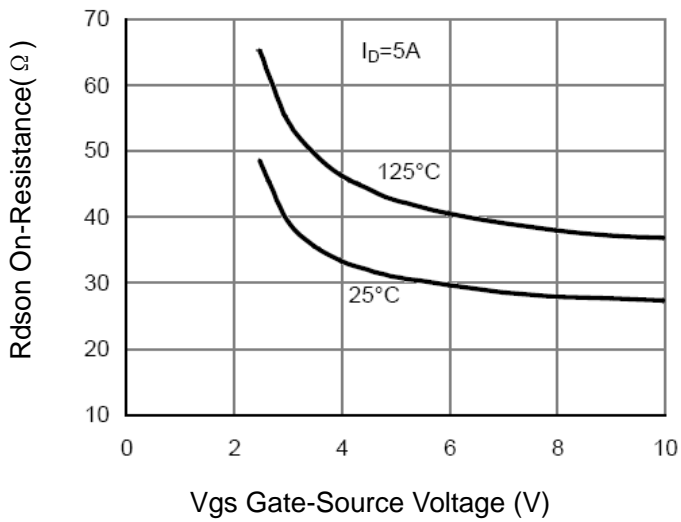

Figure 9 Rdson vs Vgs

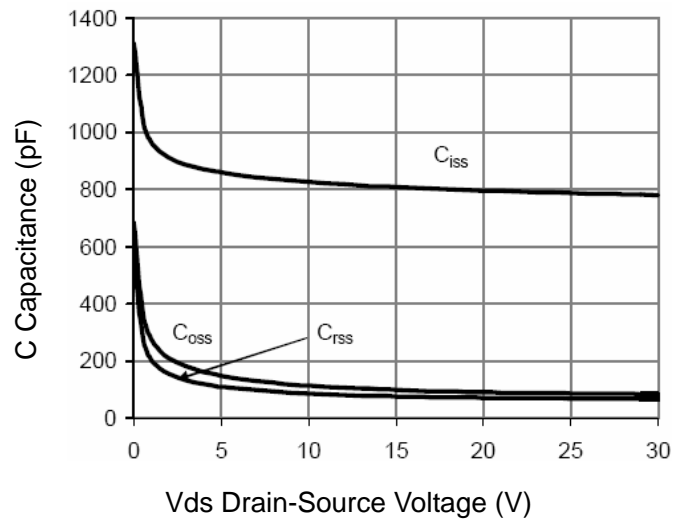

Figure 10 Capacitance vs Vds

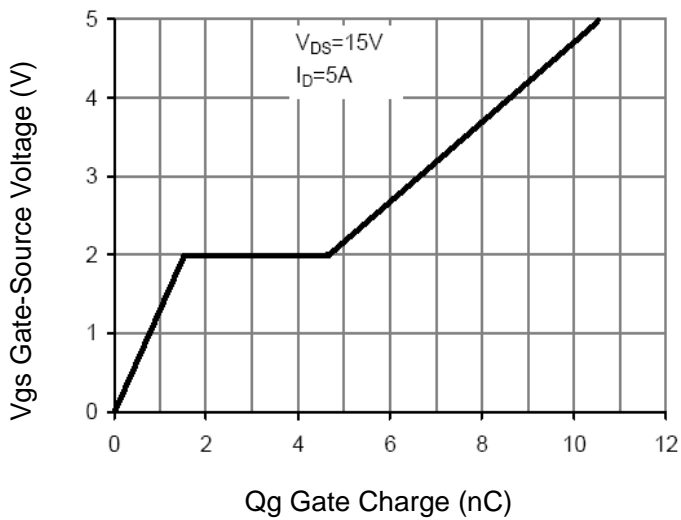

Figure 11 Gate Charge

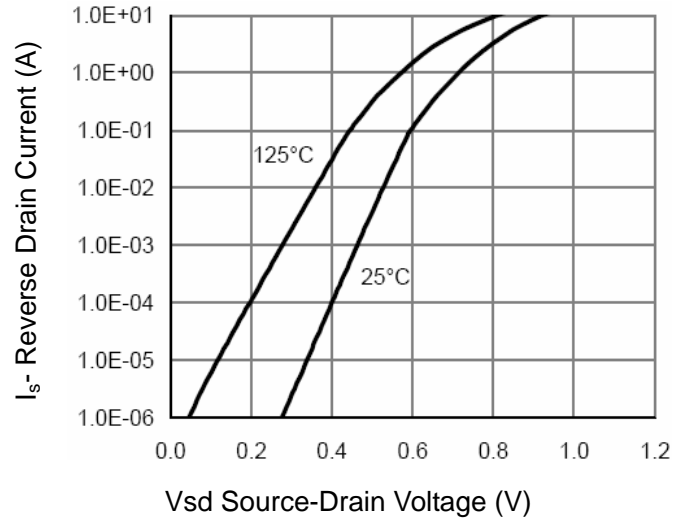

Figure 12 Source- Drain Diode Forward

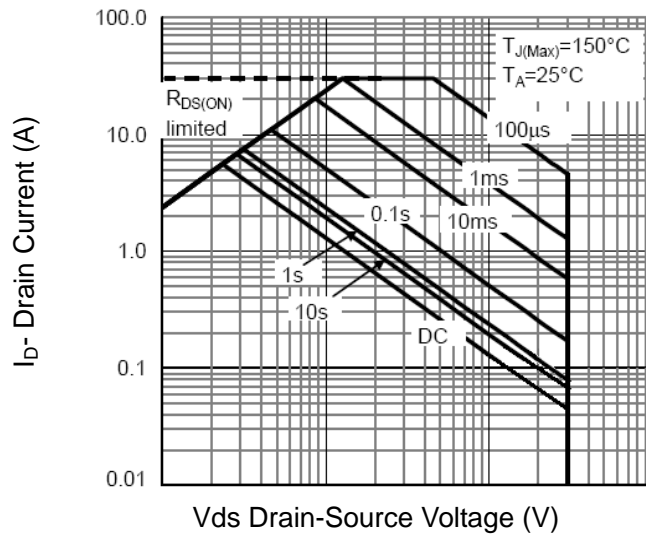

Figure 13 Safe Operation Area

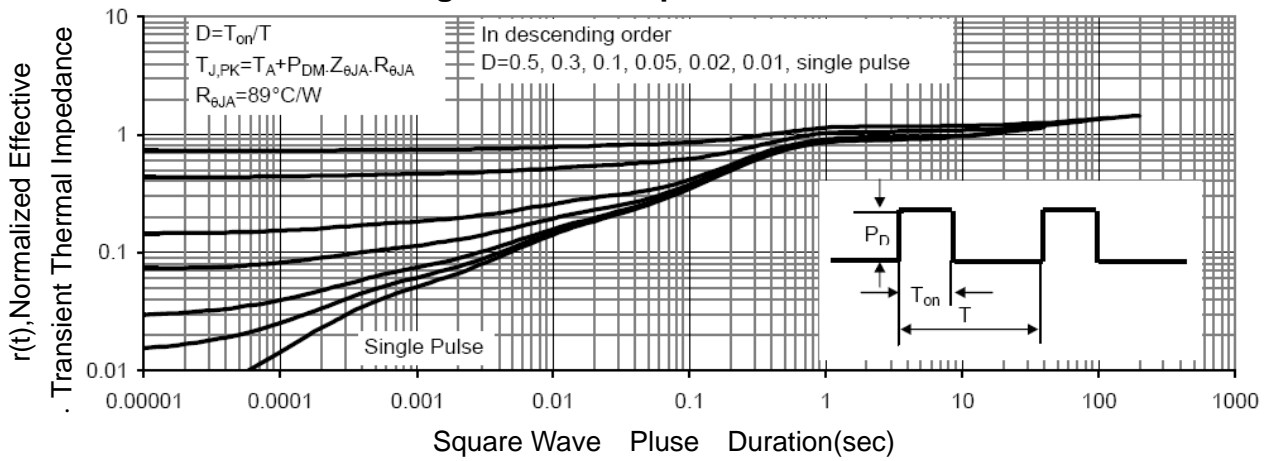
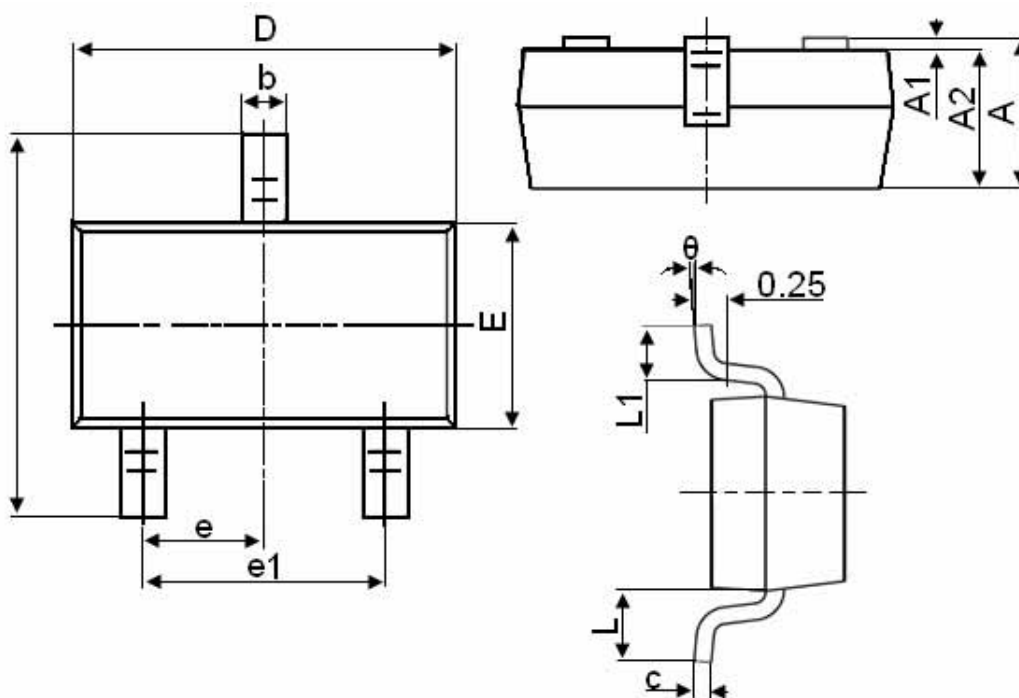

Figure 14 Normalized Maximum Transient Thermal Impedance

SOT-23 Package Information



Symbol	Dimensions in Millimeters	
	MIN.	MAX.
A	0.900	1.150
A1	0.000	0.100
A2	0.900	1.050
b	0.300	0.500
c	0.080	0.150
D	2.800	3.000
E	1.200	1.400
E1	2.250	2.550
e	0.950TYP	
e1	1.800	2.000
L	0.550REF	
L1	0.300	0.500
theta	0°	8°

Notes

1. All dimensions are in millimeters.
2. Tolerance  $\pm 0.10\text{mm}$  (4 mil) unless otherwise specified
3. Package body sizes exclude mold flash and gate burrs. Mold flash at the non-lead sides should be less than 5 mils.
4. Dimension L is measured in gauge plane.
5. Controlling dimension is millimeter, converted inch dimensions are not necessarily exact.