



LIGITEK

LIGITEK ELECTRONICS CO.,LTD.
Property of Ligitek Only

ROUND TYPE LED LAMPS



Lead-Free Parts

LWK2043-P

DATA SHEET

DOC. NO : QW0905-LWK2043-P

REV. : A

DATE : 21 - Jan. - 2009





Package Dimensions

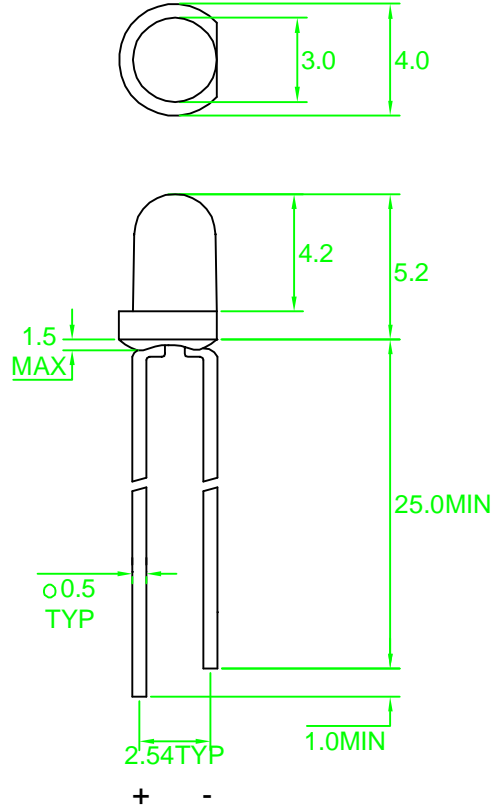

Note : 1.All dimension are in millimeter tolerance is $\pm 0.25\text{mm}$ unless otherwise noted.
2.Specifications are subject to change without notice.

Directivity Radiation

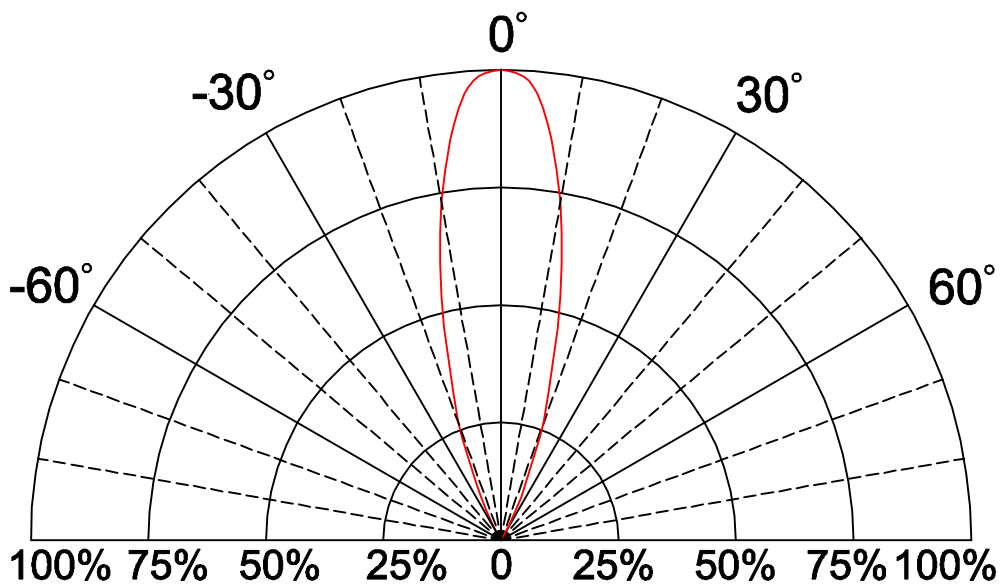

**Absolute Maximum Ratings at Ta=25**

| Parameter | Symbol | Ratings | UNIT |
|---|--------|-----------|------|
| | | WK | |
| Forward Current | IF | 30 | mA |
| Peak Forward Current Duty 1/10@10KHz | IFP | 100 | mA |
| Power Dissipation | PD | 120 | mW |
| Reverse Current @5V | Ir | 50 | μ A |
| Electrostatic Discharge(*) | ESD | 500 | V |
| Operating Temperature | Topr | -20~ +80 | |
| Storage Temperature | Tstg | -30~ +100 | |

* Static Electricity or power surge will damage the LED. Use of a conductive wrist band or anti-electrosatic glove is recommended when handing these LED. All devices, equipment and machinery must be properly grounded.

Typical Electrical & Optical Characteristics (Ta=25)

| PART NO | MATERIAL | COLOR | | Chromaticity Coordinates (Typ.) | | Forward voltage @20mA(V) | | Luminous intensity @20mA(mcd) | | Viewing angle 2 1/2 (deg) |
|-----------|-----------|---------|-------------|---------------------------------|------|--------------------------|------|-------------------------------|------|---------------------------|
| | | Emitted | Lens | X | Y | Typ. | Max. | Min. | Typ. | |
| LWK2043-P | InGaN/GaN | White | Water Clear | 0.28 | 0.28 | 3.5 | 4.0 | 1800 | 5000 | 30 |

Note : 1.The forward voltage data did not including ±0.1V testing tolerance.
2. The luminous intensity data did not including ±15% testing tolerance.



. Chromaticity Coordinates Specifications for Bin Grading

| BIN | X | Y | BIN | X | Y | BIN | X | Y |
|-----|------|-------|-----|------|-------|-----|------|-------|
| A1 | 0.21 | 0.190 | B1 | 0.26 | 0.265 | C1 | 0.31 | 0.340 |
| | 0.21 | 0.150 | | 0.26 | 0.225 | | 0.31 | 0.300 |
| | 0.22 | 0.165 | | 0.27 | 0.240 | | 0.32 | 0.315 |
| | 0.22 | 0.205 | | 0.27 | 0.280 | | 0.32 | 0.355 |
| A2 | 0.22 | 0.205 | B2 | 0.27 | 0.280 | C2 | 0.32 | 0.355 |
| | 0.22 | 0.165 | | 0.27 | 0.240 | | 0.32 | 0.315 |
| | 0.23 | 0.180 | | 0.28 | 0.255 | | 0.33 | 0.330 |
| | 0.23 | 0.220 | | 0.28 | 0.295 | | 0.33 | 0.370 |
| A3 | 0.23 | 0.220 | B3 | 0.28 | 0.295 | C3 | 0.33 | 0.370 |
| | 0.23 | 0.180 | | 0.28 | 0.255 | | 0.33 | 0.330 |
| | 0.24 | 0.195 | | 0.29 | 0.270 | | 0.34 | 0.345 |
| | 0.24 | 0.235 | | 0.29 | 0.310 | | 0.34 | 0.385 |
| A4 | 0.24 | 0.235 | B4 | 0.29 | 0.310 | C4 | 0.34 | 0.385 |
| | 0.24 | 0.195 | | 0.29 | 0.270 | | 0.34 | 0.345 |
| | 0.25 | 0.210 | | 0.30 | 0.285 | | 0.35 | 0.360 |
| | 0.25 | 0.250 | | 0.30 | 0.325 | | 0.35 | 0.400 |
| A5 | 0.25 | 0.250 | B5 | 0.30 | 0.325 | | | |
| | 0.25 | 0.210 | | 0.30 | 0.285 | | | |
| | 0.26 | 0.225 | | 0.31 | 0.300 | | | |
| | 0.26 | 0.265 | | 0.31 | 0.340 | | | |

. CIE Chromaticity Diagram

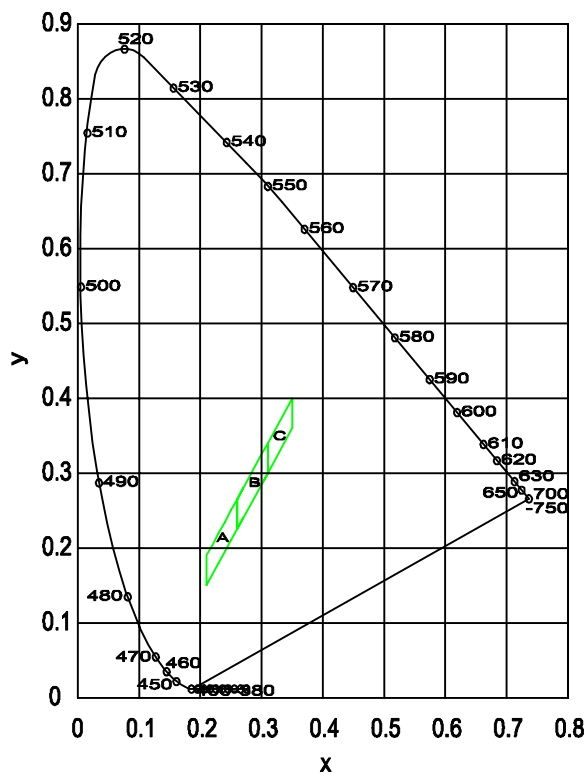



Typical Electro-Optical Characteristics Curve

WK CHIP

Fig.1 Forward current vs. Forward Voltage

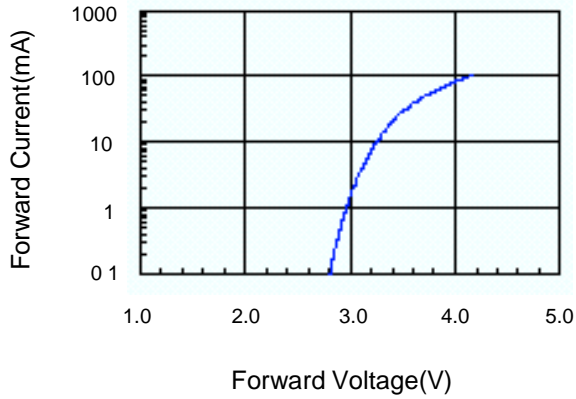

Fig.2 Relative Intensity vs. Forward Current

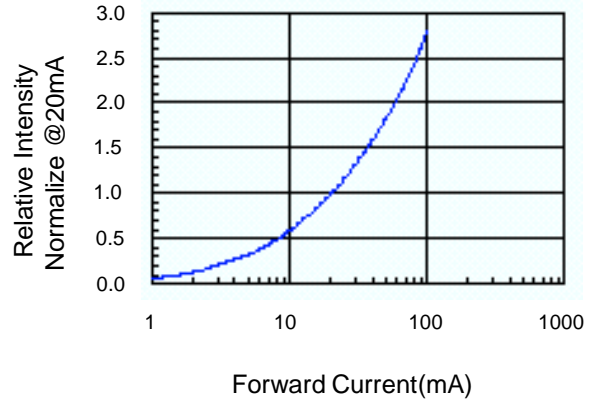

Fig.3 Forward Voltage vs. Temperature

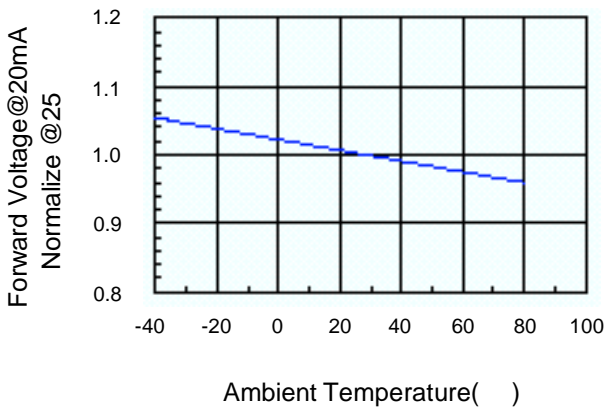

Fig.4 Relative Intensity vs. Temperature

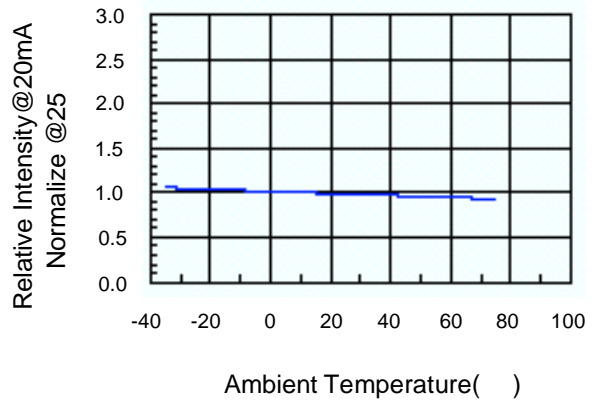
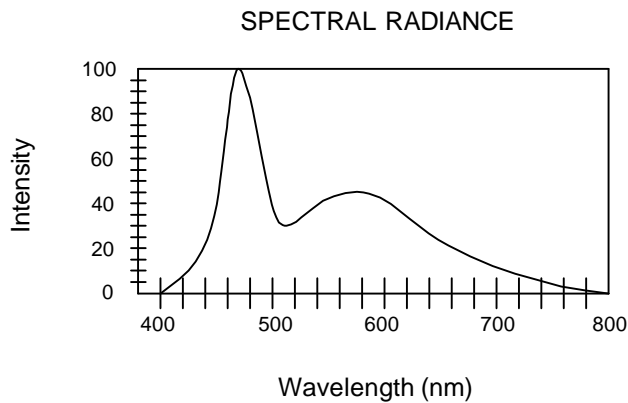

Fig.5 Luminous Spectrum (Ta=25 °C)





Soldering Condition(Pb-Free)

1.Iron:

- Soldering Iron:30W Max
- Temperature 350°C Max
- Soldering Time:3 Seconds Max(One time only)
- Distance:2mm Min(From solder joint to body)

2.Wave Soldering Profile

- Dip Soldering
- Preheat: 120°C Max
- Preheat time: 60seconds Max
- Ramp-up
- 2°C/sec(max)
- Ramp-Down:-5°C/sec(max)
- Solder Bath:260°C Max
- Dipping Time:3 seconds Max
- Distance:2mm Min(From solder joint to body)

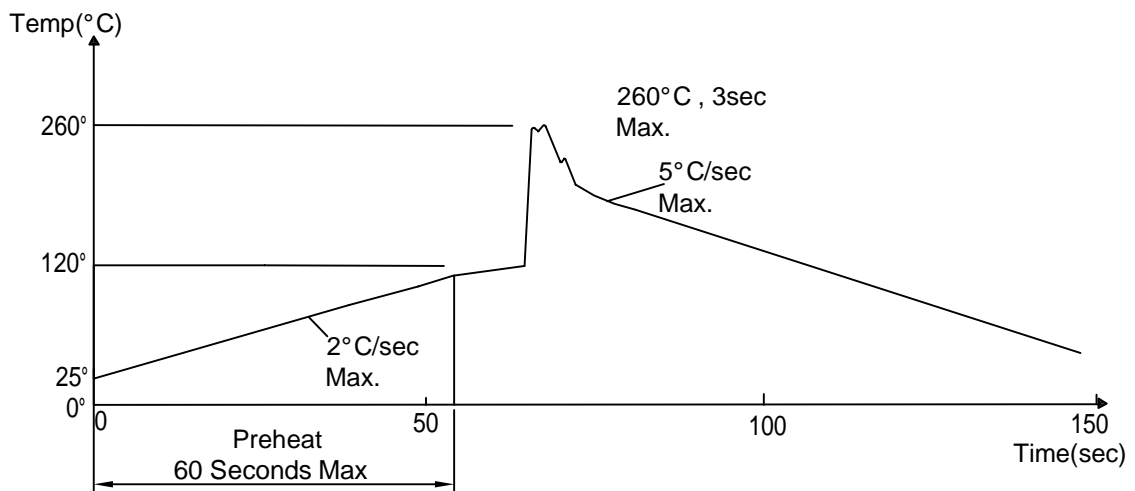

Note: 1.Wave solder should not be made more than one time.
2.You can just only select one of the soldering conditions as above.

**Reliability Test:**

| Test Item | Test Condition | Description | Reference Standard |
|-------------------------------------|--|---|--|
| Operating Life Test | 1.Under Room Temperature 2.If=20mA 3.t=1000 hrs (-24hrs, +72hrs) | This test is conducted for the purpose of determining the resistance of a part in electrical and thermal stressed. | MIL-STD-750: 1026 MIL-STD-883: 1005 JIS C 7021: B-1 |
| High Temperature Storage Test | 1.Ta=105 ±5 2.t=1000 hrs (-24hrs, +72hrs) | The purpose of this is the resistance of the device which is laid under condition of high temperature for hours. | MIL-STD-883:1008 JIS C 7021: B-10 |
| Low Temperature Storage Test | 1.Ta=-40 ±5 2.t=1000 hrs (-24hrs, +72hrs) | The purpose of this is the resistance of the device which is laid under condition of low temperature for hours. | JIS C 7021: B-12 |
| High Temperature High Humidity Test | 1.Ta=65 ±5 2.RH=90%~95% 3.t=240hrs±2hrs | The purpose of this test is the resistance of the device under tropical for hours. | MIL-STD-202:103B JIS C 7021: B-11 |
| Thermal Shock Test | 1.Ta=105 ±5 & -40 ±5 (10min) (10min) 2.total 10 cycles | The purpose of this is the resistance of the device to sudden extreme changes in high and low temperature. | MIL-STD-202: 107D MIL-STD-750: 1051 MIL-STD-883: 1011 |
| Solder Resistance Test | 1.T.Sol=260 ±5 2.Dwell time= 10±1sec. | This test intended to determine the thermal characteristic resistance of the device to sudden exposures at extreme changes in temperature when soldering the lead wire. | MIL-STD-202: 210A MIL-STD-750: 2031 JIS C 7021: A-1 |
| Solderability Test | 1.T.Sol=230 ±5 2.Dwell time=5±1sec | This test intended to see soldering well performed or not. | MIL-STD-202: 208D MIL-STD-750: 2026 MIL-STD-883: 2003 JIS C 7021: A-2 |