

CKS36-AFB80004

CKS36

MOTOR FEEDBACK SYSTEMS ROTARY INCREMENTAL WITH COMMUTATION

SICK
Sensor Intelligence.

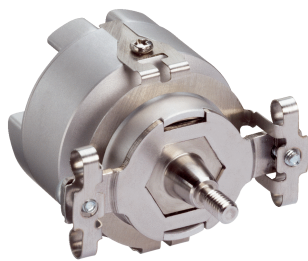

Illustration may differ

Ordering information

Type	Part no.
CKS36-AFB80004	1062488

Other models and accessories → www.sick.com/CKS36

Detailed technical data

Performance

Number of the absolute ascertainable revolutions	1
Number of lines per revolution	2,048
Measuring step	90° /number of lines
Commutation signals	4 pole pairs (according to EIA 422)
Zero pulse width	90°
Reference signal, number	1
Reference signal, position	90° or 180° configurable, electric, gated with A and B
Error limits	± 0.09°
Measuring step deviation	± 0.035°
Operating speed	12,000 min ⁻¹ , working speed up to which the output signals are correct

Interfaces

Communication interface	TTL/RS422
--------------------------------	-----------

Electrical data

Supply voltage range	4.5 V DC ... 5.5 V DC
Operating power consumption (no load)	< 60 mA ¹⁾
Maximum output frequency	≤ 400 kHz

¹⁾ Without load.

Mechanical data

Shaft version	Tapered shaft
Flange type / stator coupling	Spring mounting plate
Dimensions	See dimensional drawing
Weight	0.065 kg
Moment of inertia of the rotor	4.5 gcm ²
Operating speed	120,000 min ⁻¹ ¹⁾
Angular acceleration	≤ 500,000 rad/s ²
Operating torque	0.2 Ncm
Start up torque	0.3 Ncm

¹⁾ Self warming of 1.1 K per 1000 revolutions/min when applying note working temperature range.

Permissible shaft movement, radial static/dynamic	± 0.1 mm / ± 0.05 mm
Permissible shaft movement, axial static/dynamic	± 0.2 mm / ± 0.1 mm
Life of ball bearings	3.6 x 10 ⁹ revolutions
Connection type	Connector, 14-pin, axial

¹⁾ Self warming of 1.1 K per 1000 revolutions/min when applying note working temperature range.

Ambient data

Operating temperature range	-20 °C ... +110 °C
Storage temperature range	-40 °C ... +125 °C, without package
Relative humidity/condensation	90 %, Condensation not permitted
Resistance to shocks	100 g, 6 ms (according to EN 60068-2-27)
Frequency range of resistance to vibrations	50 g, 10 Hz ... 2,000 Hz (according to EN 60068-2-6)
EMC	According to EN 61000-6-2 and EN 61000-6-3 ¹⁾
Enclosure rating	IP50, with mating connector inserted and closed cover (according to IEC 60529)

¹⁾ The EMC according to the standards quoted is achieved when the motor feedback system is mounted in an electrically conductive housing, which is connected to the central earthing point of the motor controller via a cable screen. The GND-(0 V) connection of the supply voltage is also grounded here. If other shielding concepts are used, users must perform their own tests.

Classifications

ECl@ss 5.0	27270501
ECl@ss 5.1.4	27270501
ECl@ss 6.0	27270590
ECl@ss 6.2	27270590
ECl@ss 7.0	27270501
ECl@ss 8.0	27270501
ECl@ss 8.1	27270501
ECl@ss 9.0	27270501
ETIM 5.0	EC001486
ETIM 6.0	EC001486
UNSPSC 16.0901	41112113

Dimensional drawing (Dimensions in mm (inch))

General tolerances according to DIN ISO 2768-mk

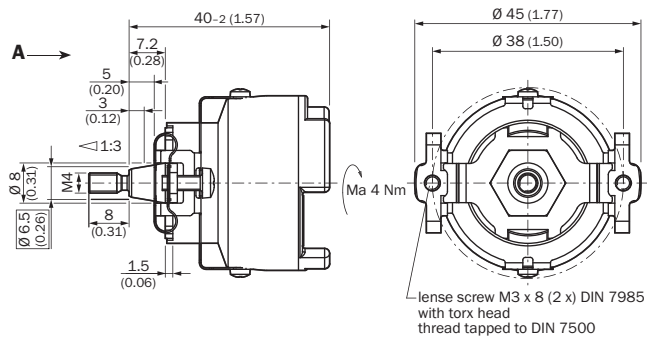

Proposed fitting

General tolerances according to DIN ISO 2768-mk

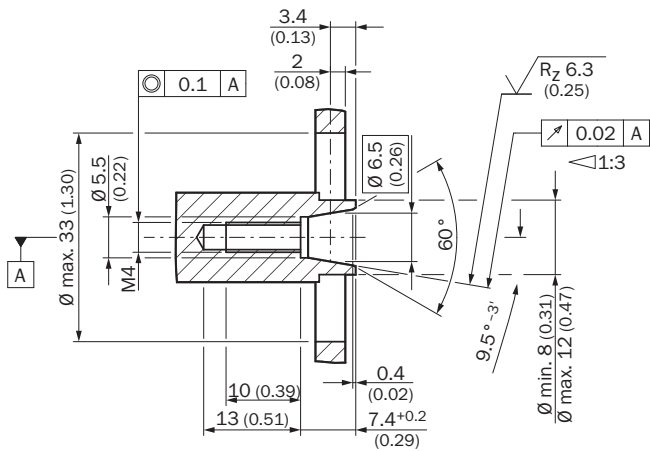

All dimensions in mm (inch)

PIN assignment

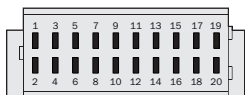

Diagram

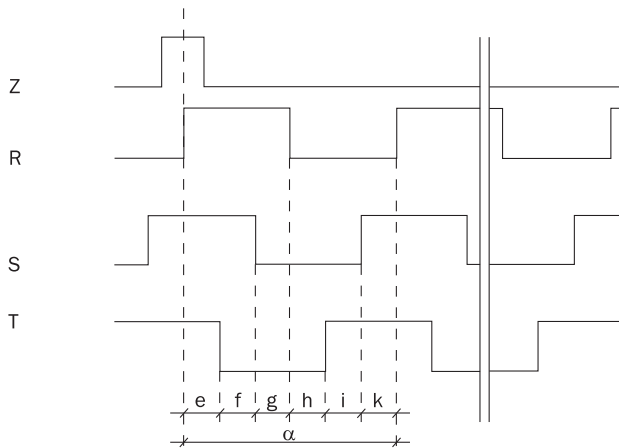

At constant speed, looking at the input shaft, and clockwise rotation

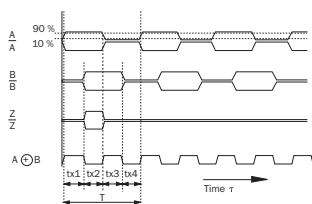



At constant rotational speed with regard to the input shaft and rotation in clockwise direction.
 By connecting the two signals A and B, an output signal arises whose period durations tx1 ... tx4 have varying lengths.
 The differences are determined:

- by the pulse/pause ratio tolerance of the individual channels
- by the tolerance in the 90° phase shift between A and B
- by the frequency

The times tx1 ... tx4 ideally have to amount to 1/4 of the particular period duration T. The typical output frequency of the encoder is defined so that the max. time tx is smaller than 1.5 x T/4.

Recommended accessories

Other models and accessories → www.sick.com/CKS36

	Brief description	Type	Part no.
Other mounting accessories			
	Mounting tools	BEF-MW-SKX36	2031079
Plug connectors and cables			
	Head A: female connector, stranded cable, 14-pin, straight Head B: cable Cable: Incremental, unshielded, 0.2 m	DOL-1J14-G0M2XB7	6030948
	Head A: female connector, JST, 8-pin, straight Head B: male connector, M23, 17-pin, straight Cable: Incremental, unshielded, 1 m	DSL-2317-G01MJB7	2071332
	Head A: female connector, terminal box, 8-pin, straight Head B: male connector, M23, 17-pin, straight Cable: Incremental, unshielded, 1 m	DSL-2317-G01MJC7	2071331

	Brief description	Type	Part no.
Programming and configuration tools			
	SVip® LAN programming tool for all motor feedback systems	PGT-11-S LAN	1057324
	SVip® WLAN programming tool for all motor feedback systems	PGT-11-S WLAN	1067474

SICK AT A GLANCE

SICK is one of the leading manufacturers of intelligent sensors and sensor solutions for industrial applications. A unique range of products and services creates the perfect basis for controlling processes securely and efficiently, protecting individuals from accidents and preventing damage to the environment.

We have extensive experience in a wide range of industries and understand their processes and requirements. With intelligent sensors, we can deliver exactly what our customers need. In application centers in Europe, Asia and North America, system solutions are tested and optimized in accordance with customer specifications. All this makes us a reliable supplier and development partner.

Comprehensive services complete our offering: SICK LifeTime Services provide support throughout the machine life cycle and ensure safety and productivity.

For us, that is “Sensor Intelligence.”

WORLDWIDE PRESENCE:

Contacts and other locations –www.sick.com