

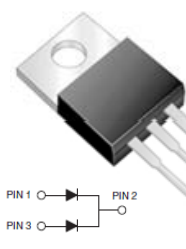

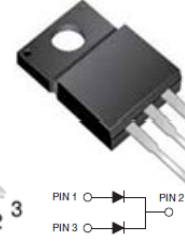

**HTR20I45CT, HTRF20I45CT**  
**HTRI20I45CT, HTRB20I45CT**

SCHOTTKY BARRIER RECTIFIERS	REVERSE VOLTAGE	45	Volts	
	FORWARD CURRENT	20	Amperes	
<b>FEATURES</b> <ul style="list-style-type: none"> <li>●Metal of silicon rectifier , majority carrier conduction</li> <li>●Trench Schottky Technology</li> <li>●Low power loss, high efficiency</li> <li>●High current capability, low VF</li> <li>●High surge capacity</li> <li>●Plastic package has <b>UL</b> flammability classification 94V-0</li> <li>●For use in low voltage,high frequency inverters,free wheeling,<b>switching power supplies, DC-DC converter</b>,and polarity protection applications</li> </ul> <b>MECHANICAL DATA</b> <ul style="list-style-type: none"> <li>●Case: TO-220AB / ITO-220AB / TO-262AA / TO-263AB</li> <li>●Polarity: As marked on the body</li> <li>●Weight: 0.08ounces,2.24 grams</li> <li>●Mounting position :Any</li> </ul>	<b>TO-220AB</b>  HTR20I45CT	<b>ITO-220AB</b>  HTRF20I45CT	 <b>HALOGEN FREE</b> <b>RoHS COMPLIANT</b>	
	<b>TO-263AB</b>  HTRB20I45CT	<b>TO-262AA</b>  HTRI20I45CT		

**MAXIMUM RATINGS AND ELECTRICAL CHARACTERISTICS**

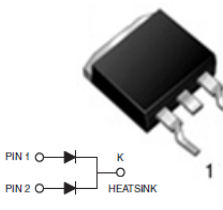
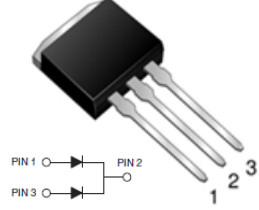
Rating at 25°C ambient temperature unless otherwise specified.  
 Single phase, half wave ,60Hz, resistive or inductive load.  
 For capacitive load, derate current by 20%

**MAXIMUM RATINGS (T<sub>A</sub> = 25 °C unless otherwise noted)**

CHARACTERISTICS	SYMBOL	HTR20I45CT, HTRF20I45CT, HTRI20I45CT, HTRB20I45CT	UNIT
Maximum Recurrent Peak Reverse Voltage	V <sub>RRM</sub>	45	V
Maximum RMS Voltage	V <sub>RMS</sub>	31	V
Maximum DC Blocking Voltage	V <sub>DC</sub>	45	V
Maximum Average Forward Rectified Current ( See Fig.1)	I <sub>(AV)</sub>	20	A
Maximum Average Forward Rectified Current ( Per Leg )		10	
Peak Forward Surge Current 8.3ms Single Half Sine-Wave Super Imposed on Rated Load	I <sub>FSM</sub>	150	A
Peak repetitive reverse current at tp = 2 μs, 1 kHz	I <sub>RRM</sub>	1	A
Operating Temperature Range	T <sub>J</sub>	-55 to +150	°C
Storage Temperature Range	T <sub>STG</sub>	-55 to +175	°C

**ELECTRICAL CHARACTERISTICS (T<sub>A</sub> = 25 °C unless otherwise noted)**

PARAMETER / CONDITIONS	SYMBOL	Typ	Max	UNIT	
Breakdown voltage per diode	V <sub>BR</sub>	45(minimun)	-	V	
Forward Voltage (Note1)	V <sub>F</sub>	IF=5A @TJ=25°C	0.36	0.38	V
		IF=5A @TJ=125°C	0.27	0.29	
		IF=10A @TJ=25°C	0.42	0.44	
		IF=10A @TJ=125°C	0.35	0.36	
Maximum DC Reverse Current @TJ=25°C	I <sub>R</sub>		500	uA	
at Rated DC Bolcking Voltage @TJ=125°C			110	mA	
Typical Junction Capacitance (Note2)	C <sub>J</sub>		1468	pF	

**THERMAL CHARACTERISTICS (T<sub>A</sub> = 25 °C unless otherwise noted)**

PARAMETER	SYMBOL	Typ				UNIT
		HTR20I45CT	HTRF20I45CT	HTRI20I45CT	HTRB20I45CT	
Thermal Resistance Per Diode (Note3)	R <sub>θJC</sub>	3.0	5.5	3.5	3.5	°C/W

NOTES:1.300us pulse width,2% duty cycle.  
 2.Measured at 1.0 MHz and applied reverse voltage of 5.0V DC.  
 3.Thermal resistance junction to case.

# RATING AND CHARACTERISTIC CURVES

HTR20I45CT, HTRF20I45CT

HTRI20I45CT, HTRB20I45CT

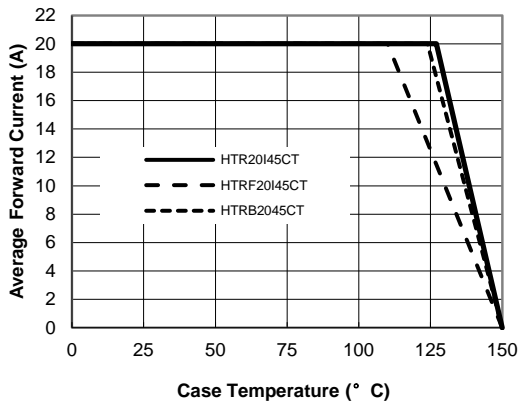

Figure 1. Forward Current Derating Curve

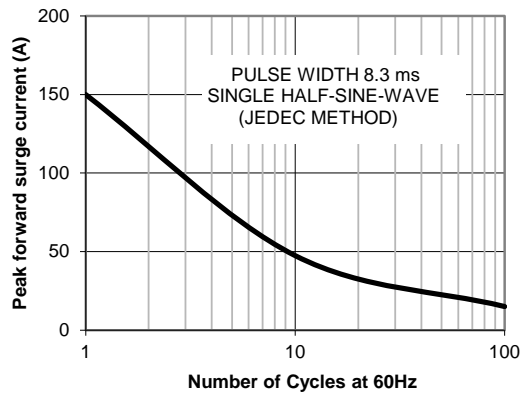

Figure 2. Maximum NON-Repetitive Surge

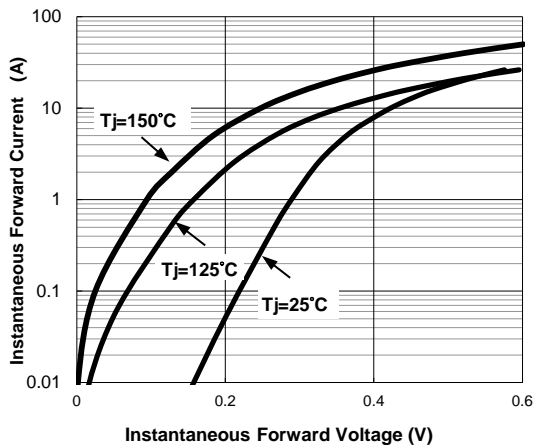

Figure 3. Typical Instantaneous Forward Characteristics Per Leg

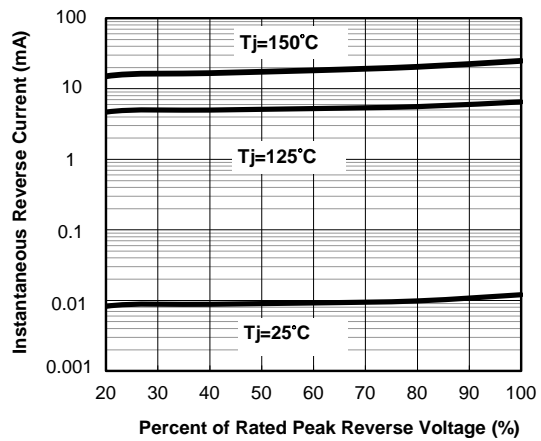

Figure 4. Typical Reverse Characteristics

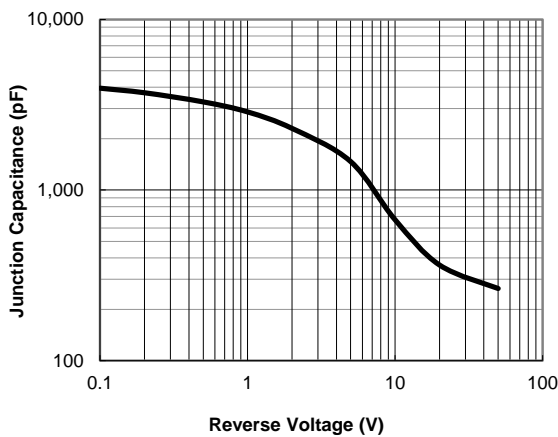

Figure 5. Typical Junction Capacitance

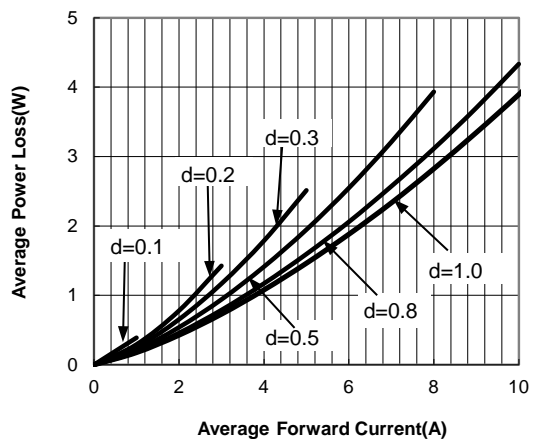

Figure 6. Forward Power Loss Characteristics

**PACKAGE OUTLINE DIMENSIONS** in millimeters

HTR20I45CT, HTRF20I45CT

HTRI20I45CT, HTRB20I45CT



TO-220AB

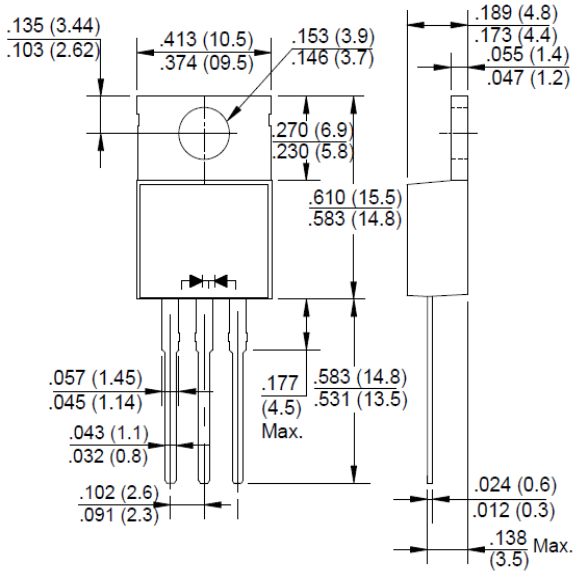

TO-262AA

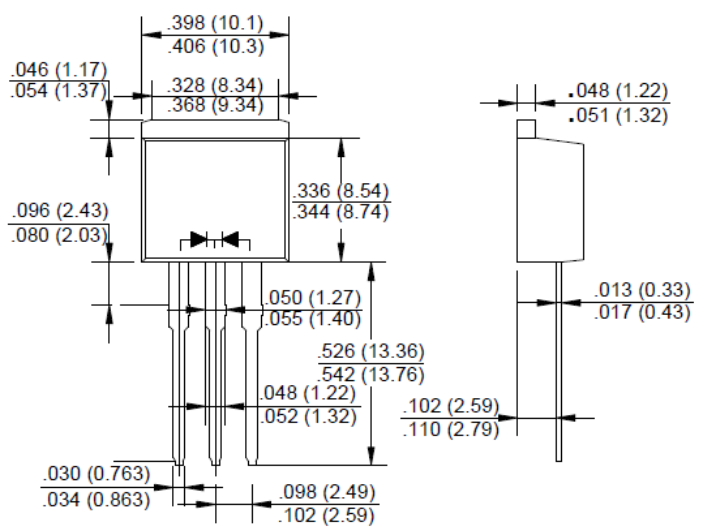

TO-263AB

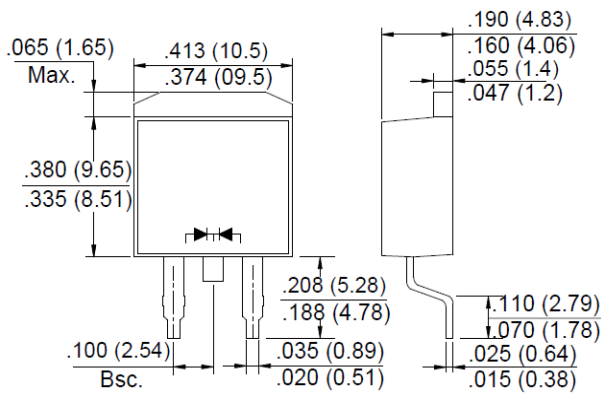

ITO-220AB

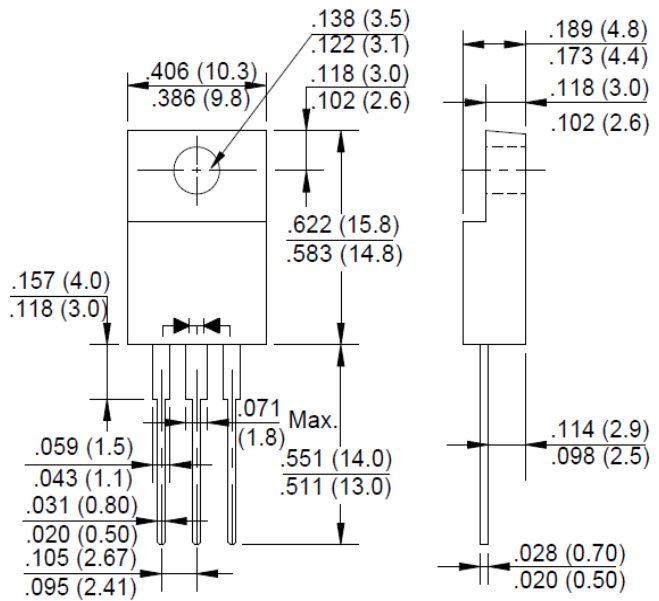

---

**Disclaimer**

ALL specifications and data are subject to bechanged without notice to improve reliability function or design or other reasons.

HY makes no warranty, representation or guarantee regarding the suitability of the products for any particular purpose or the continuing production of any product. To the maximum extent permitted by applicable law, HY disclaims (i) any and all liability arising out of the application or use of any product, (ii) any and all liability, including without limitation special, consequential or incidental damages, and (iii) any and all implied warranties, including warranties of fitness for particular purpose, non-infringement and merchantability.

Statements regarding the suitability of products for certain types of applications are based on HY's knowledge of typical requirements that are often placed on HY products in generic applications. Such statements are not binding statements about the suitability of products for a particular application. It is the customer's responsibility to validate that a particular product with the properties described in the product specification is suitable for use in a particular application. Parameters provided in datasheets and specifications may vary in different applications and performance may vary over time. All operating parameters, including typical parameters, must be validated for each customer application by the customer's technical experts. Product specifications do not expand or otherwise modify HY's terms and conditions of purchase, including but not limited to the warranty expressed therein.

Except as expressly indicated in writing, HY products are not designed for use in medical, life-saving, or life-sustaining applications or for any other application in which the failure of the HY product could result in personal injury or death. Customers using or selling HY products not expressly indicated for use in such applications do so at their own risk. Please contact authorized HY personnel to obtain written terms and conditions regarding products designed for such applications.

No license, express or implied, by estoppel or otherwise, to any intellectual property rights is granted by this document or by any conduct of HY. Product names and markings noted herein may be trademarks of their respective owners.