

## General Description

KEC Field Stop Trench IGBTs offer low switching losses, high energy efficiency and short circuit ruggedness.

It is designed for applications such as motor control, uninterrupted power supplies(UPS), general inverters.

## FEATURES

- High speed switching
- High ruggedness, temperature stable behavior
- Short Circuit Withstand Times 10us
- Extremely enhanced avalanche capability

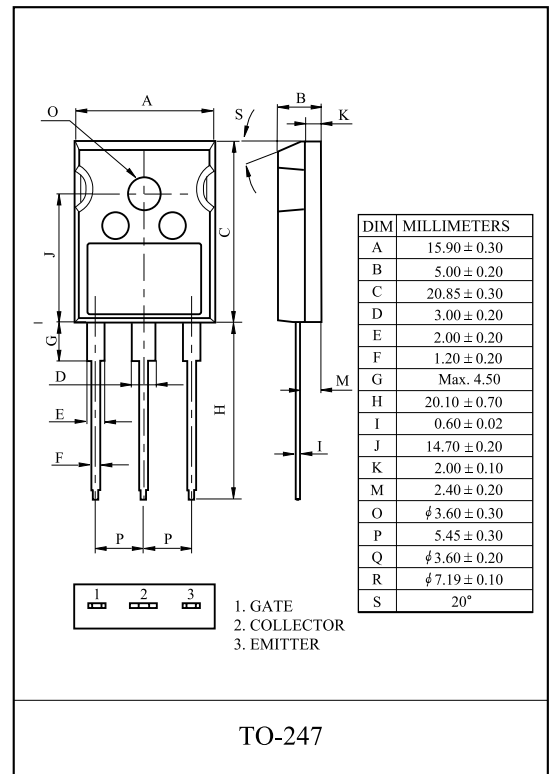

## MAXIMUM RATING (Ta=25 °C)

CHARACTERISTIC	SYMBOL	RATING	UNIT
Collector-Emitter Voltage	$V_{CES}$	600	V
Gate-Emitter Voltage	$V_{GES}$	± 20	V
Collector Current	$I_C$	@Tc=25	60 A
		@Tc=100	30 A
Pulsed Collector Current	$I_{CM}^*$	90	A
Diode Continuous Forward Current	@Tc=25	$I_F$	30 A
Diode Maximum Forward Current	$I_{FM}^*$	90	A
Maximum Power Dissipation	$P_D$	@Tc=25	178 W
		@Tc=100	71 W
Maximum Junction Temperature	$T_j$	150	
Storage Temperature Range	$T_{stg}$	-55 to + 150	

\*Repetitive rating : Pulse width limited by max. junction temperature

## THERMAL CHARACTERISTIC

CHARACTERISTIC	SYMBOL	MAX.	UNIT
Thermal Resistance, Junction to Case (IGBT)	$R_{thJC}$	0.7	/W
Thermal Resistance, Junction to Case (DIODE)	$R_{thJC}$	1.55	/W
Thermal Resistance, Junction to Ambient	$R_{thJA}$	40	/W

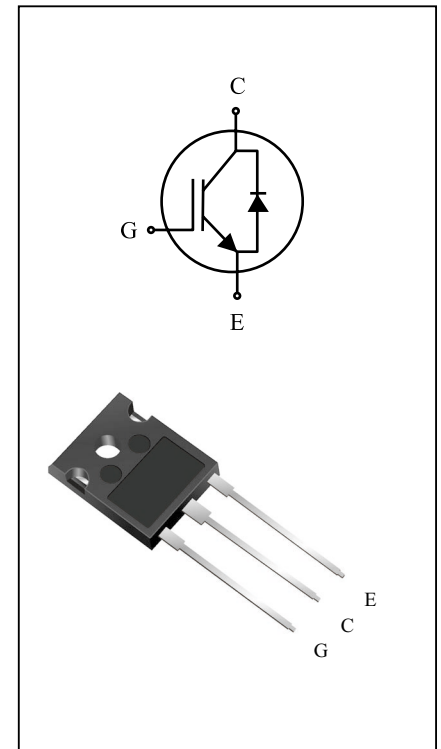

# KGF30N60KDA

## ELECTRICAL CHARACTERISTICS (Ta=25 )

CHARACTERISTIC	SYMBOL	TEST CONDITION	MIN.	TYP.	MAX.	UNIT	
<b>Static</b>							
Collector-Emitter Breakdown Voltage	$BV_{CES}$	$V_{GE}=0V, I_C=250\mu A$	600	-	-	V	
Collector Cut-off Current	$I_{CES}$	$V_{GE}=0V, V_{CE}=600V$	-	-	250	$\mu A$	
Gate Leakage Current	$I_{GES}$	$V_{CE}=0V, V_{GE}=\pm 20V$	-	-	$\pm 100$	nA	
Gate Threshold Voltage	$V_{GE(th)}$	$V_{GE}=V_{CE}, I_C=3mA$	4.5	5.5	7.0	V	
Collector-Emitter Saturation Voltage	$V_{CE(sat)}$	$V_{GE}=15V, I_C=30A$	-	1.65	2.1	V	
		$V_{GE}=15V, I_C=60A$	-	2.25	-	V	
		$V_{GE}=15V, I_C=30A, T_C = 125$	-	1.9	-	V	
<b>Dynamic</b>							
Total Gate Charge	$Q_g$	$V_{CC}=300V, V_{GE}=15V, I_C=30A$	-	120	-	nC	
Gate-Emitter Charge	$Q_{ge}$		-	20	-	nC	
Gate-Collector Charge	$Q_{gc}$		-	60	-	nC	
Turn-On Delay Time	$t_{d(on)}$	$V_{CC}=300V, I_C=30A, V_{GE}=15V, R_G=10$ Inductive Load, $T_C = 25$ (Note 1)	-	40	-	ns	
Rise Time	$t_r$		-	30	-	ns	
Turn-Off Delay Time	$t_{d(off)}$		-	170	-	ns	
Fall Time	$t_f$		-	35	-	ns	
Turn-On Switching Loss	$E_{on}$		-	0.55	0.75	mJ	
Turn-Off Switching Loss	$E_{off}$		-	0.45	0.65	mJ	
Total Switching Loss	$E_{ts}$		-	1.0	1.4	mJ	
Turn-On Delay Time	$t_{d(on)}$		$V_{CC}=300V, I_C=30A, V_{GE}=15V, R_G=10$ Inductive Load, $T_C = 125$ (Note 1)	-	40	-	ns
Rise Time	$t_r$			-	35	-	ns
Turn-Off Delay Time	$t_{d(off)}$			-	180	-	ns
Fall Time	$t_f$	-		50	-	ns	
Turn-On Switching Loss	$E_{on}$	-		0.55	-	mJ	
Turn-Off Switching Loss	$E_{off}$	-		0.65	-	mJ	
Total Switching Loss	$E_{ts}$	-		1.2	-	mJ	
Input Capacitance	$C_{ies}$	$V_{CE}=30V, V_{GE}=0V, f=1MHz$	-	2350	3100	pF	
Output Capacitance	$C_{oes}$		-	160	-	pF	
Reverse Transfer Capacitance	$C_{res}$		-	95	-	pF	
Short Circuit Withstand Time	$t_{sc}$		$V_{CC}=300V, V_{GE}=15V, T_C=100$	10	-	-	$\mu s$

Note 1 : Energy loss include tail current and diode reverse recovery.

### Marking

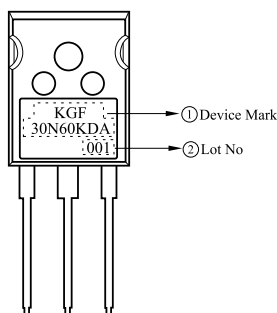

# KGF30N60KDA

## ELECTRICAL CHARACTERISTIC OF DIODE

CHARACTERISTIC	SYMBOL	TEST CONDITION		MIN.	TYP.	MAX.	UNIT
Diode Forward Voltage	$V_F$	$I_F = 30A$	$T_C = 25$	-	1.7	2.5	V
			$T_C = 125$	-	1.75	-	
Diode Reverse Recovery Time	$t_{rr}$	$V_{CE} = 300V$	$T_C = 25$	-	80	-	ns
			$T_C = 125$	-	120	-	
Diode Peak Reverse Recovery Current	$I_{rr}$	$I_F = 30A$	$T_C = 25$	-	14	-	A
			$T_C = 125$	-	16	-	
Diode Reverse Recovery Charge	$Q_{rr}$	$di/dt = -600A/\mu s$	$T_C = 25$	-	620	-	nC
			$T_C = 125$	-	1160	-	

# KGF30N60KDA

## Typical Performance Characteristics

Fig 1. Saturation Voltage Characteristics

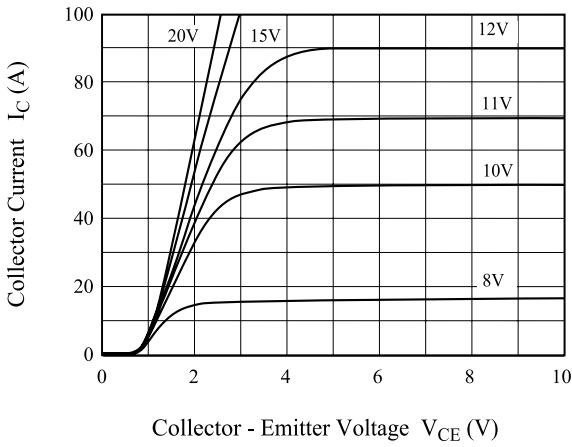

Fig 2. Saturation Voltage Characteristics

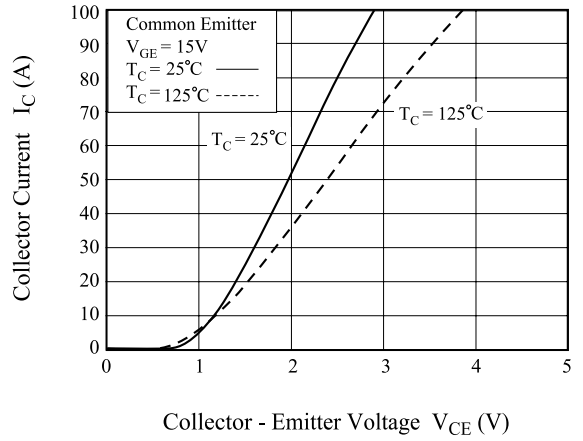

Fig 3. Saturation Voltage vs. Case Temperature

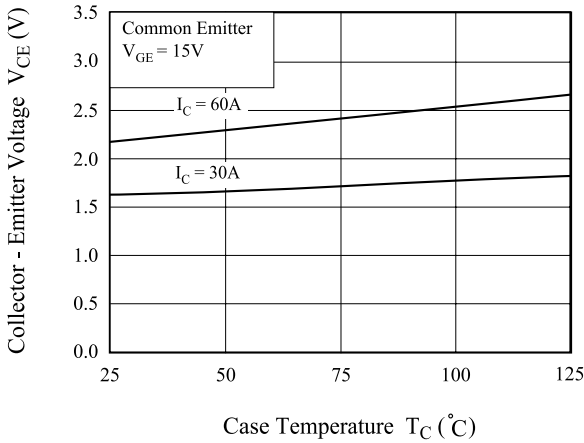

Fig 4. Saturation Voltage vs.  $V_{GE}$

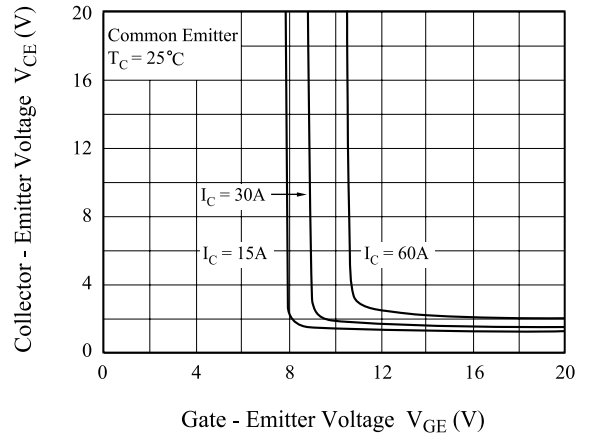

Fig 5. Saturation Voltage vs.  $V_{GE}$

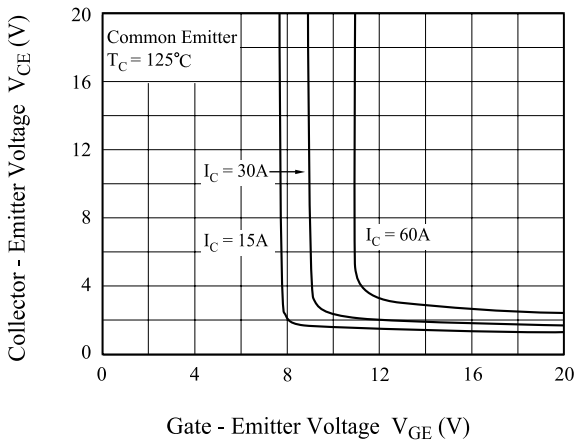
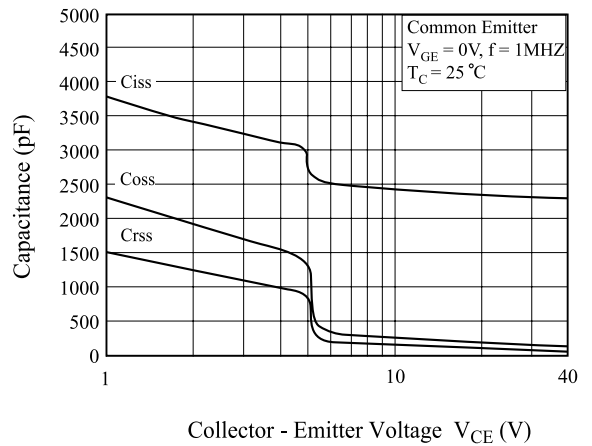

Fig 6. Capacitance Characteristics



# KGF30N60KDA

## Typical Performance Characteristics (Continued)

Fig 7. Turn-On Characteristics vs. Gate Resistance

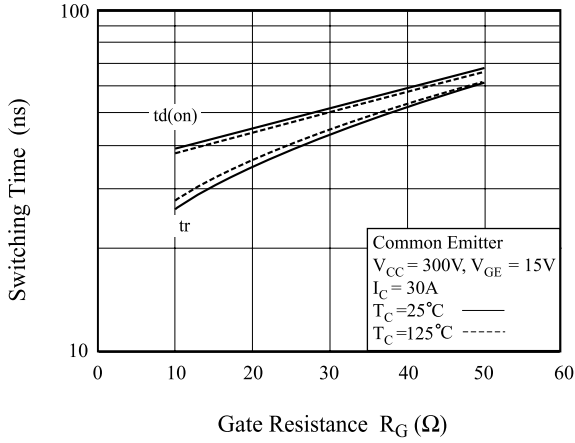

Fig 8. Turn-Off Characteristics vs. Gate Resistance

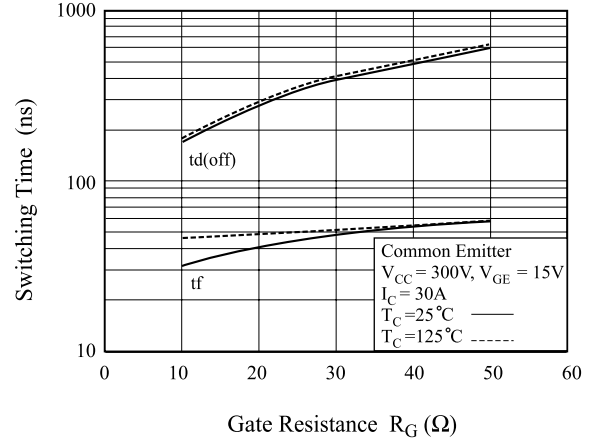

Fig 9. Switching Loss vs. Gate Resistance

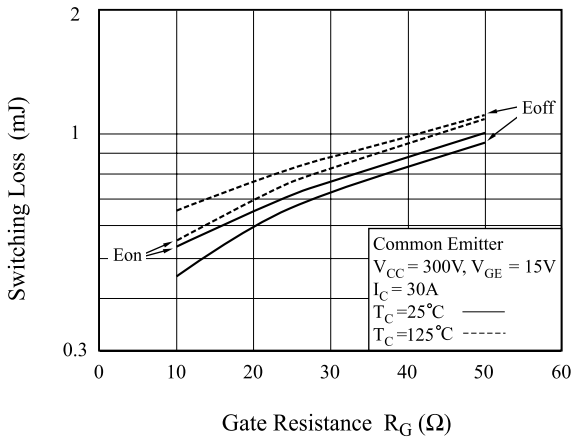

Fig 10. Turn-On Characteristics vs. Collector Current

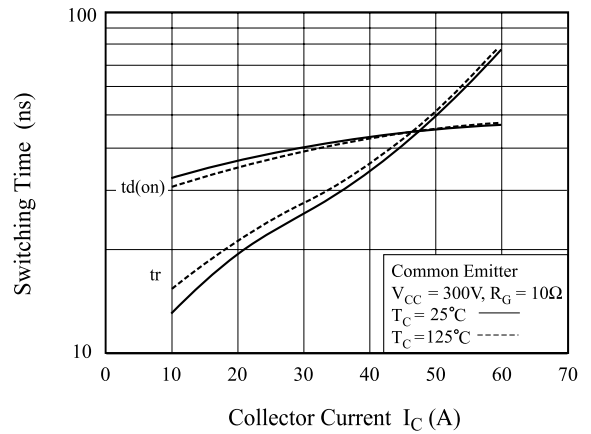

Fig 11. Turn-Off Characteristics vs. Collector Current

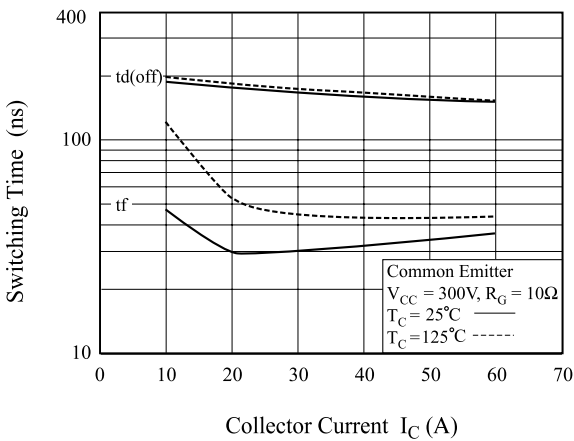
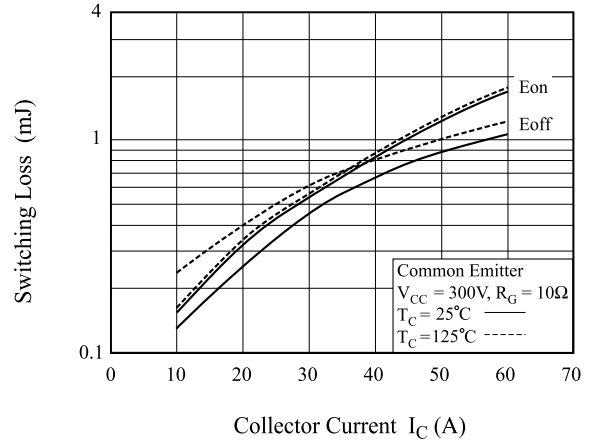

Fig 12. Switching Loss vs. Collector Current



# KGF30N60KDA

## Typical Performance Characteristics (Continued)

Fig 13. Gate Charge Characteristics

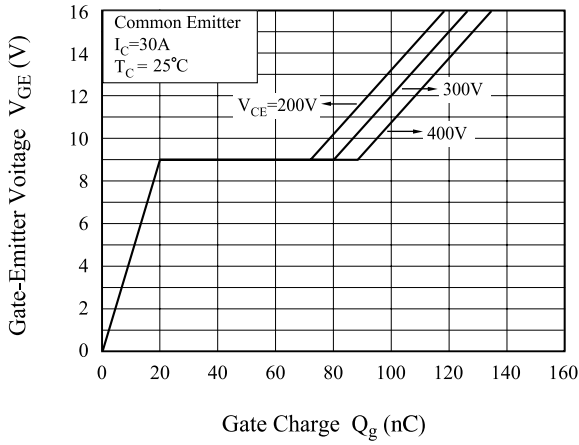

Fig 14. SOA Characteristics

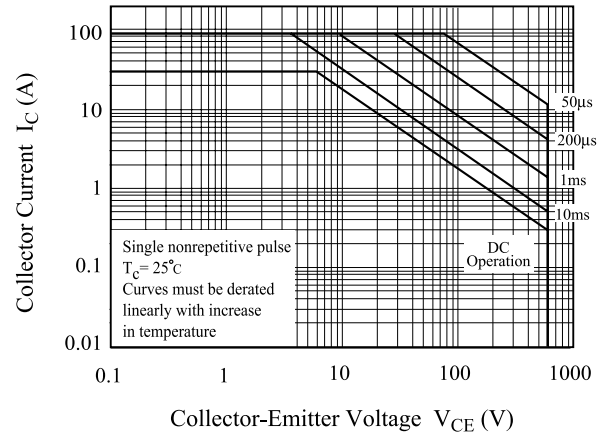

Fig 15. Turn-Off SOA

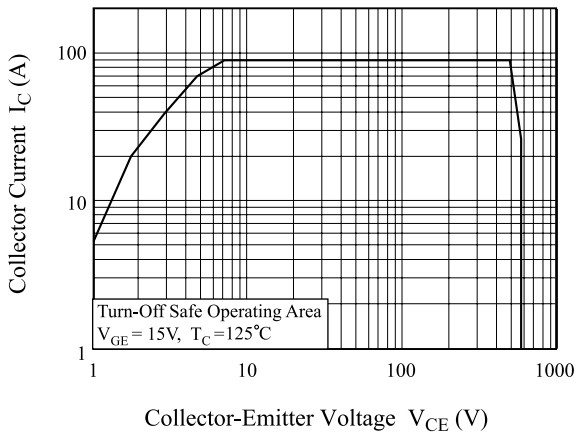
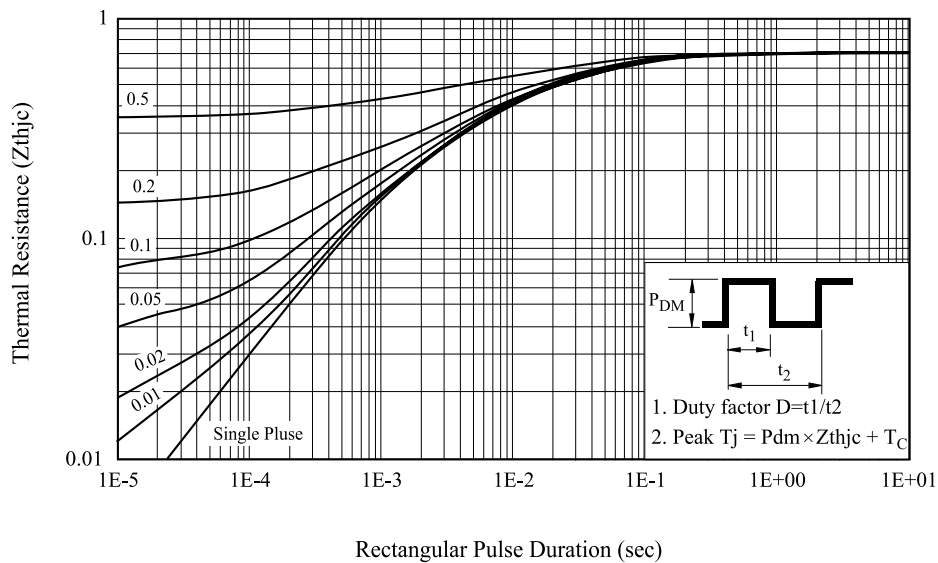

Fig 16. Transient Thermal Impedance of IGBT



# KGF30N60KDA

## Typical Performance Characteristics

Fig 17. Forward Characteristics

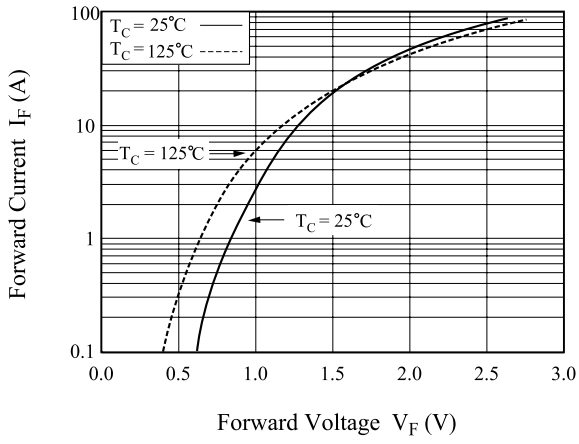

Fig 18. Reverse Recovery Current

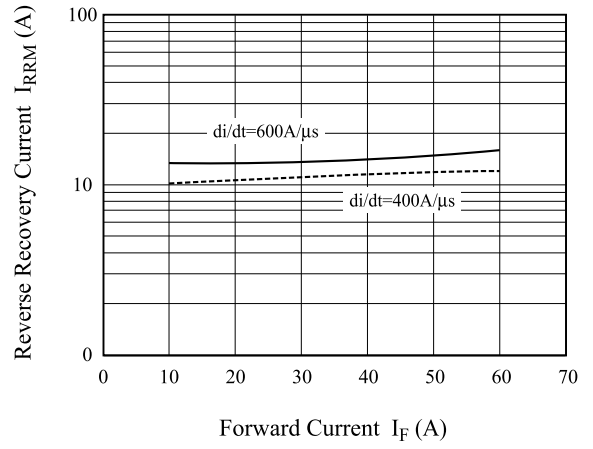
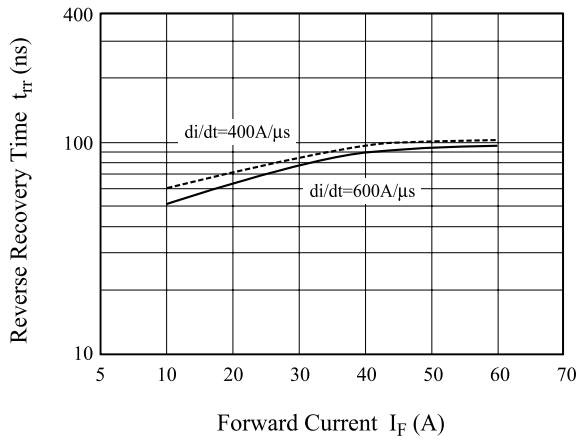

Fig 19. Reverse Recovery Time



## Definition Switching Time & Loss.

Fig 20. Switching Test Circuit

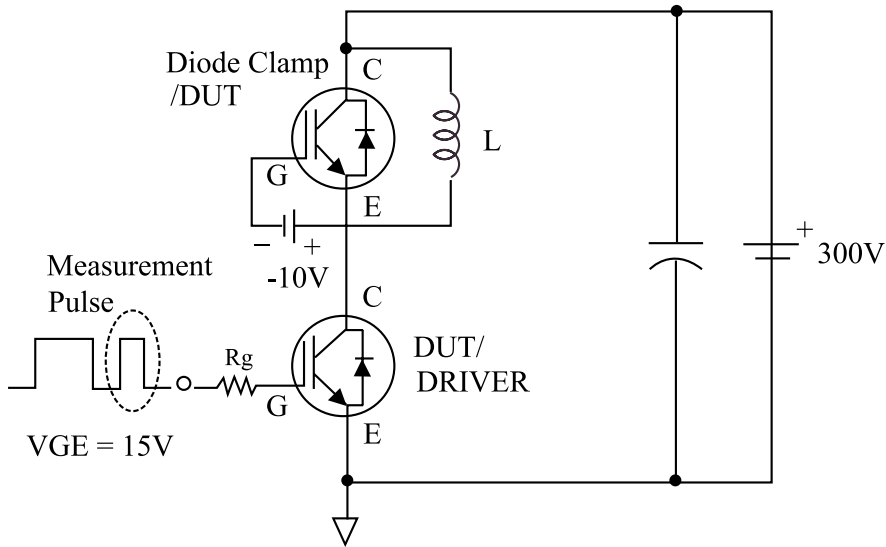

Fig 21. Definition Switching Time & Loss

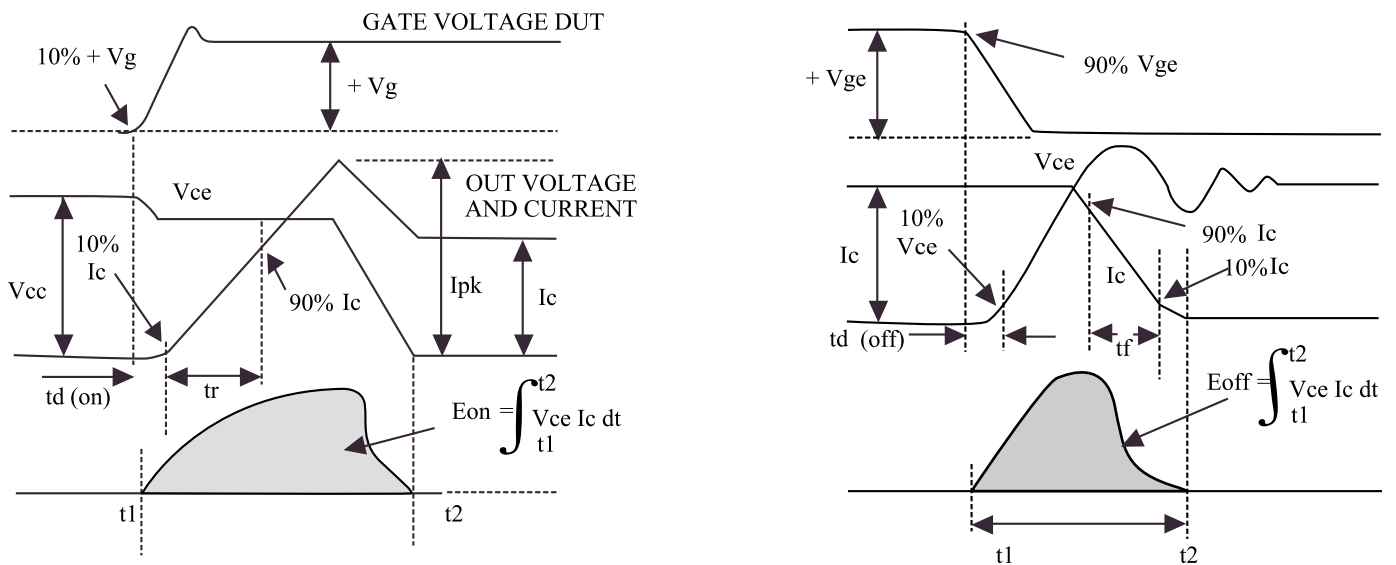

Fig 22. Definition Diode Switching Time

