MAX17574 5V Output Evaluation Kit

Evaluates: MAX17574 in 5V Output-Voltage Application

General Description

The MAX17574 5V output evaluation kit (EV kit) provides a proven design to evaluate the MAX17574 high-voltage, high-efficiency, synchronous step-down DC-DC converter. The EV kit is preset for 5V output at load currents up to 3A and features a 500kHz switching frequency for optimum efficiency and component size. The EV kit features adjustable input undervoltage lockout, adjustable soft-start, open-drain $\overline{\text{RESET}}$ signal, and external frequency synchronization.

Ordering Information appears at end of data sheet.

Features

- Operates from a 6.5V to 60V Input Supply
- 5V Output Voltage
- Up to 3A Output Current
- 500kHz Switching Frequency
- Enable/UVLO Input, Resistor-Programmable UVLO Threshold
- Adjustable Soft-Start Time
- MODE/SYNC Pin to Select Among PWM, PFM, or DCM Modes
- Open-Drain $\overline{\text{RESET}}$ Output
- External Frequency Synchronization
- Overcurrent and Overtemperature Protection
- Proven PCB Layout
- Fully Assembled and Tested

Quick Start

Recommended Equipment

- MAX17574 5V output EV kit
- 6.5V to 60V, 5A DC input power supply
- Load capable of sinking 3A
- Digital voltmeter (DVM)

Procedure

The EV kit is fully assembled and tested. Follow the steps below to verify the board operation. **Caution: Do not turn on power supply until all connections are completed.**

- 1) Set the power supply at a voltage between 6.5V and 60V. Disable the power supply.
- 2) Connect the positive terminal of the power supply to the VIN PCB pad and the negative terminal to the nearest PGND PCB pad. Connect the positive terminal of the 3A load to the VOUT PCB pad and the negative terminal to the nearest PGND PCB pad.
- 3) Connect the DVM across the VOUT PCB pad and the nearest PGND PCB pad.
- 4) Verify that shunts are installed across pins 1-2 on jumper JU1 and pins 2-3 on jumper JU3 (see [Table 1](#) for details).
- 5) Select the shunt position on jumper JU2 according to the intended mode of operation (see [Table 2](#) for details).
- 6) Turn on the DC power supply.
- 7) Enable the load.
- 8) Verify that the DVM displays 5V.

Detailed Description

The MAX17574 5V output EV kit provides a proven design to evaluate the MAX17574 high-voltage, high-efficiency, synchronous step-down DC-DC converter. The EV kit is preset for 5V output from 6.5V to 60V input at load currents up to 3A and features a 500kHz switching frequency for optimum efficiency and component size.

The EV kit includes an EN/UVLO PCB pad and jumper JU1 to enable the output at a desired input voltage. The SYNC PCB pad and jumper JU3 allow an external clock to synchronize the device. Jumper JU2 allows the selection of a particular MODE/SYNC of operation based on light-load performance requirements. An additional $\overline{\text{RESET}}$ PCB pad is available for monitoring whether the converter output is in regulation.

Soft-Start Input (SS)

The device utilizes an adjustable soft-start function to limit inrush current during startup. The soft-start time is adjusted by the value of C8, the external capacitor from SS to GND. The selected output capacitance (C_{SEL}) and the output voltage (V_{OUT}) determine the minimum value of C8, as shown by the following equation:

$$C8 \geq 28 \times 10^{-6} \times C_{\text{SEL}} \times V_{\text{OUT}}$$

The soft-start time (t_{SS}) is related to C8 by the following equation:

$$t_{\text{SS}} = C8 / (5.55 \times 10^{-6})$$

For example, to program a 1ms soft-start time, C8 should be 5.6nF.

Regulator Enable/Undervoltage-Lockout Level (EN/UVLO)

The device offers an adjustable input undervoltage-lockout level. For normal operation, a shunt should be installed across pins 1-2 on jumper JU1. To disable the output, install a shunt across pins 2-3 on JU1 and the EN/UVLO pin is pulled to GND. See [Table 1](#) for JU1 settings.

Set the voltage at which the device turns on with the resistive voltage-divider R1/R2 connected from VIN_ to SGND. Connect the center node of the divider to EN/UVLO.

Choose R1 to be 3.32MΩ and then calculate R2 as follows:

$$R2 = \frac{R1 \times 1.215}{(V_{INU} - 1.215)}$$

where V_{INU} is the voltage at which the device is required to turn on.

Table 1. Regulator Enable (EN/UVLO) Description (JU1)

SHUNT POSITION	EN/UVLO PIN	MAX17574_ OUTPUT
1-2*	Connected to VIN	Enabled
Not installed	Connected to the center node of resistor-divider R1 and R2	Enabled, UVLO level set through the R1 and R2 resistors
2-3	Connected to SGND	Disabled

*Default position.

MODE Selection (MODE/SYNC)

The device's MODE/SYNC pin can be used to select among PWM, PFM, or DCM modes of operation. The logic state of the MODE/SYNC pin is latched when VCC and EN/UVLO voltages exceed the respective UVLO rising thresholds and all internal voltages are ready to allow LX switching. State changes on the MODE/SYNC pin are ignored during normal operation. Refer to the MAX17574 IC data sheet for more information on the PWM, PFM, and DCM modes of operation.

[Table 2](#) shows EV kit jumper settings that can be used to configure the desired mode of operation.

External Clock Synchronization (MODE/SYNC)

The internal oscillator of the device can be synchronized to an external clock signal on the SYNC pin. The external synchronization clock frequency must be between 1.1f_{SW} and 1.4f_{SW}, where f_{SW} is the frequency of operation set by R3. The minimum external clock high pulse width should be greater than 50ns and the minimum external clock low pulse width should be greater than 160ns.

Table 2. MODE/SYNC Description (JU2)

SHUNT POSITION	MODE/SYNC PIN	MAX17574_ MODE
Not installed*	Unconnected	PFM mode of operation
2-3	Connected to SGND	PWM mode of operation
1-2	Connected to VCC	DCM mode of operation

*Default position.

EV Kit Test Report

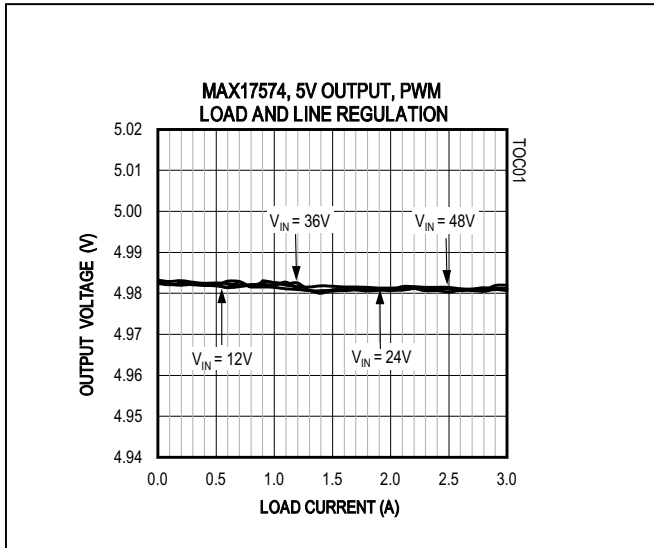

Figure 1. MAX17574 5V Output Load and Line Regulation (PWM Mode)

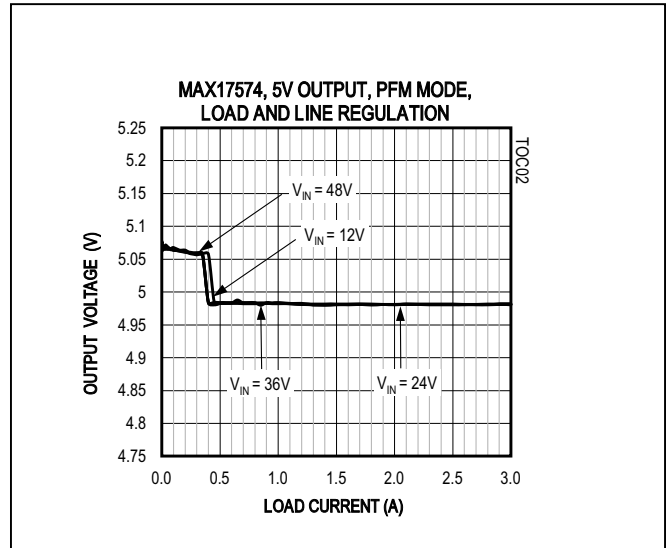

Figure 3. MAX17574 5V Output Load and Line Regulation (PFM Mode)

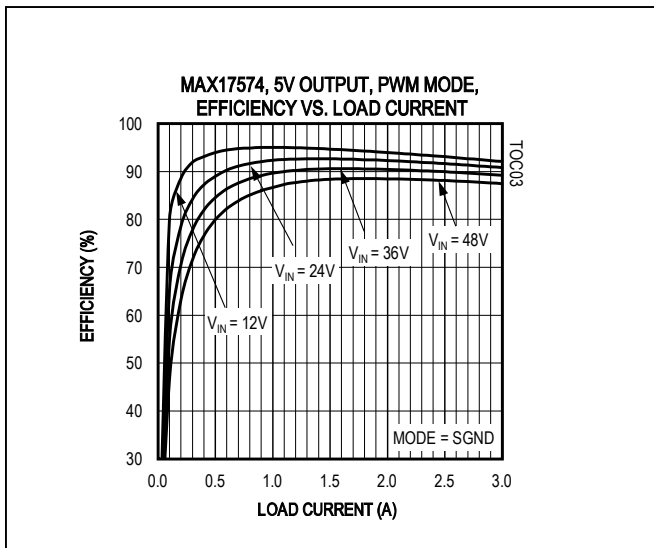

Figure 2. MAX17574 5V Output Efficiency (PWM Mode)

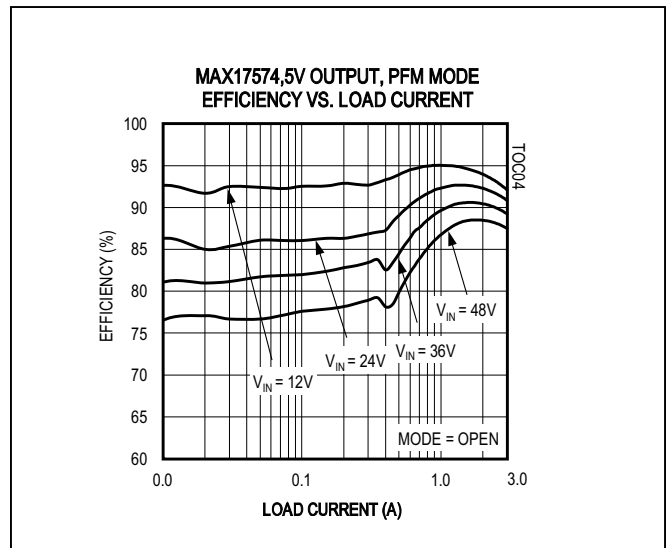

Figure 4. MAX17574 5V Output Efficiency (PFM Mode)

EV Kit Test Report (continued)

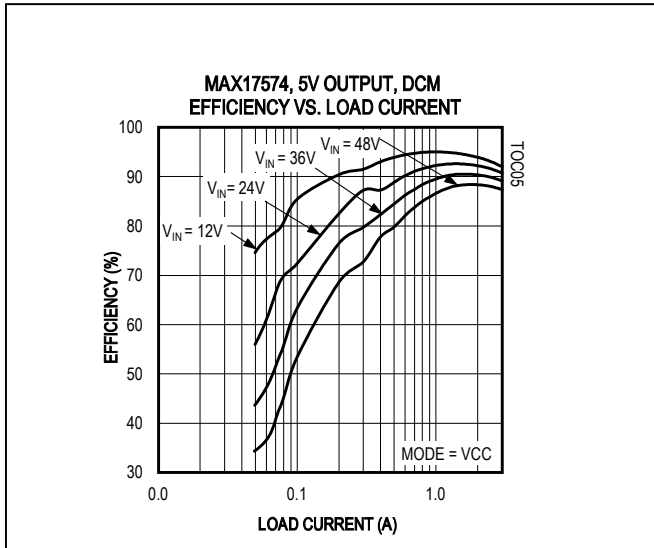

Figure 5. MAX17574 5V Output Efficiency (DCM Mode)

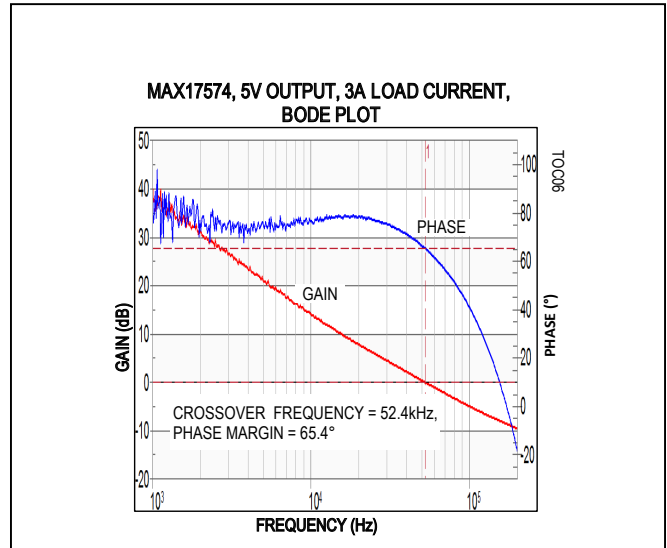

Figure 6. MAX17574 5V Output Full Load Bode Plot ($V_{IN} = 24V$)

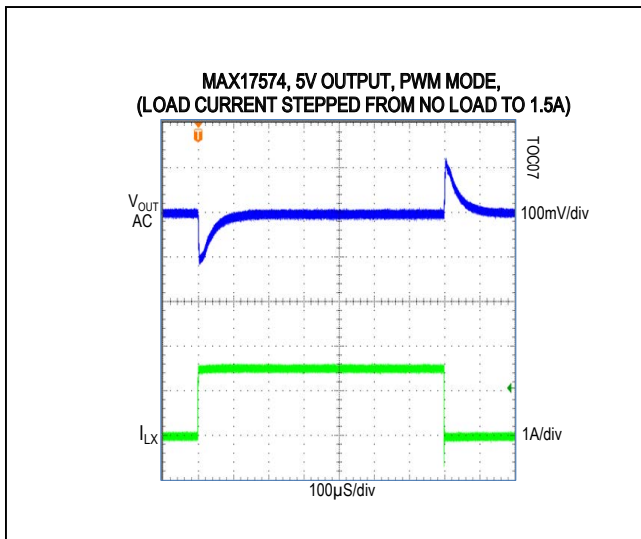

Figure 7. MAX17574 5V Output, No Load to 1A Load Transient (PWM Mode)

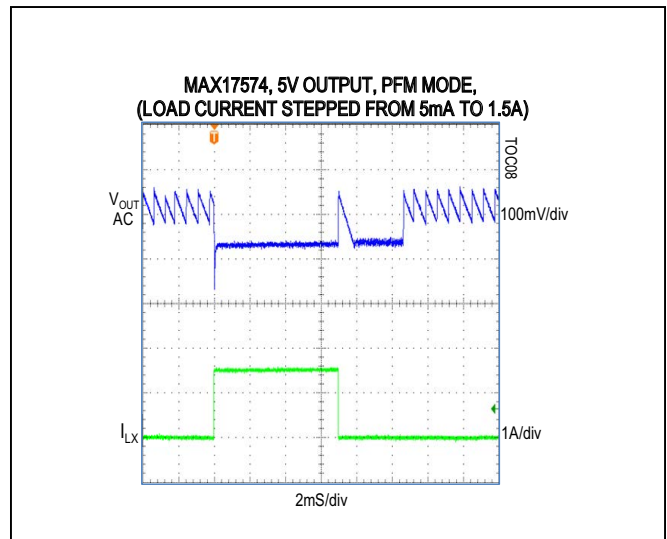

Figure 8. MAX17574 5V Output, 5mA to 1A Load Transient (PFM Mode)

EV Kit Test Report (continued)

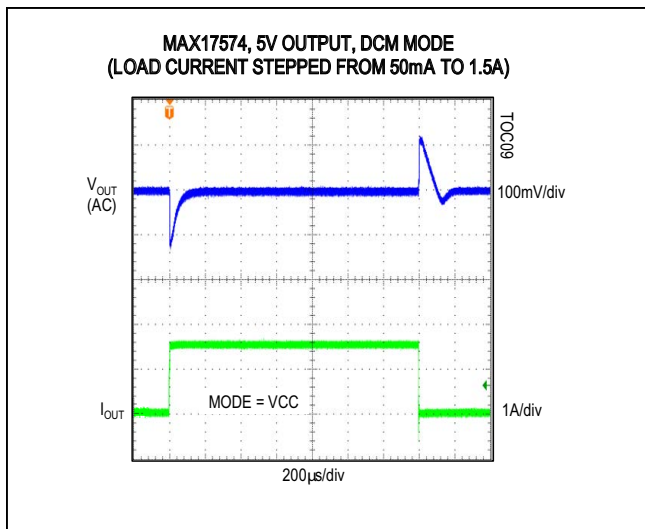

Figure 9. MAX17574 5V Output, 50mA to 1A Load Transient (DCM Mode)

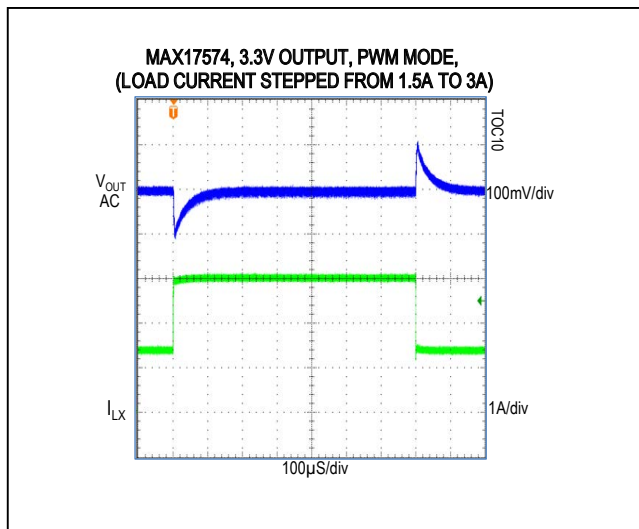

Figure 10. MAX17574 5V Output, 1A to 2A Load Transient

Component Suppliers

SUPPLIER	WEBSITE
Coilcraft, Inc.	www.coilcraft.com
Murata Americas	www.murata.com
Panasonic Corp.	www.panasonic.com
Taiyo Yuden	www.t-yuden.com
TDK Corp.	www.tdk.com

Note: Indicate that you are using the MAX17574 when contacting these component suppliers.

Ordering Information

PART	TYPE
MAX17574EVKITB#	EV Kit

#Denotes RoHS compliant.

MAX17574 5V EV System Bill of Materials

SERIAL NO.	DESCRIPTION	QUANTITY	DESIGNATOR	PART NUMBER
1	2.2 μ F \pm 10%, 100V X7R ceramic capacitor (1210)	2	C1,C2	MURATA GRM32ER72A225KA35
2	22 μ F \pm 10%, 10V X7R ceramic capacitor (1210)	2	C3,C4	MURATA GRM32ER71A226K
3	0.1 μ F \pm 10%, 50V X7R ceramic capacitor (0402)	2	C5,C9	MURATA GRM155R71H104KE14
4	2.2 μ F \pm 10%, 10V X7R ceramic capacitor (0603)	1	C6	MURATA GRM188R71A225KE15
5	47 μ F, 80V electrolytic capacitor (6.3mm. Dia.)	1	C7	PANASONIC EEE-FK1K470P
6	0.022 μ F \pm 10%, 50V X7R ceramic capacitor (0402)	1	C8	MURATA GRM155R71H223KA12
7	0.1 μ F \pm 10%, 100V X7R ceramic capacitor (0603)	1	C11	MURATA GRM188R72A104KA35
8	2-pin header (36-pin header 0.1" centers)	2	JU1, JU2	Sullins: PEC03SAAN
9	10 μ H Inductor (4mm x 4mm x 3mm)	1	L1	Coilcraft XAL8080-103ME
10	3.3M ohm \pm 1%, resistor (0603)	1	R1	Any
11	604k ohm \pm 1%, resistor (0603)	1	R2	Any
12	10k ohm \pm 1%, resistor (0402)	1	R4	Any
13	4.7 ohm \pm 1%, resistor (0402)	1	R5	Any
14	105k ohm \pm 1%, resistor (0402)	1	R6	Any
15	22.6k ohm \pm 1%, resistor (0402)	1	R7	Any
16	Buck Converter MAX17574ATG+	1	U1	MAX17574ATG+
17	OPEN	1	C10	
18	OPEN	1	R3	
19	Shunt	2	See the jumper table	SULLINS STC02SYAN
20	Test Loops	8	VIN, SGND, VOUT, PGND1, PGND2, RESET/, EN/UVLO, MODE/SYNC	9020 BUSS WEICO WIRE
21	MEDIUM BROWN 9 3/8" X 7 1/4" X 2 1/2	1	Pack-out	
22	WEB instructions for Maxim Data Sheet	1	Pack-out	
23	Label	1	Pack-out	
24	BAG; STATIC SHIELD 5X8;W/ESD LOGO	1	Pack-out	
25	FOAM, ANTI-STATIC PE 12"x12"X5MM	1	Pack-out	
26	Rubber bumpers, 3M SJ-5003	4	Pack-out	

Jumper Table

JUMPER	SHUNT POSITION
JU1	1-2
JU2	2-3 for PWM and 1-2 for PFM mode

MAX17574 5V EV System Schematic

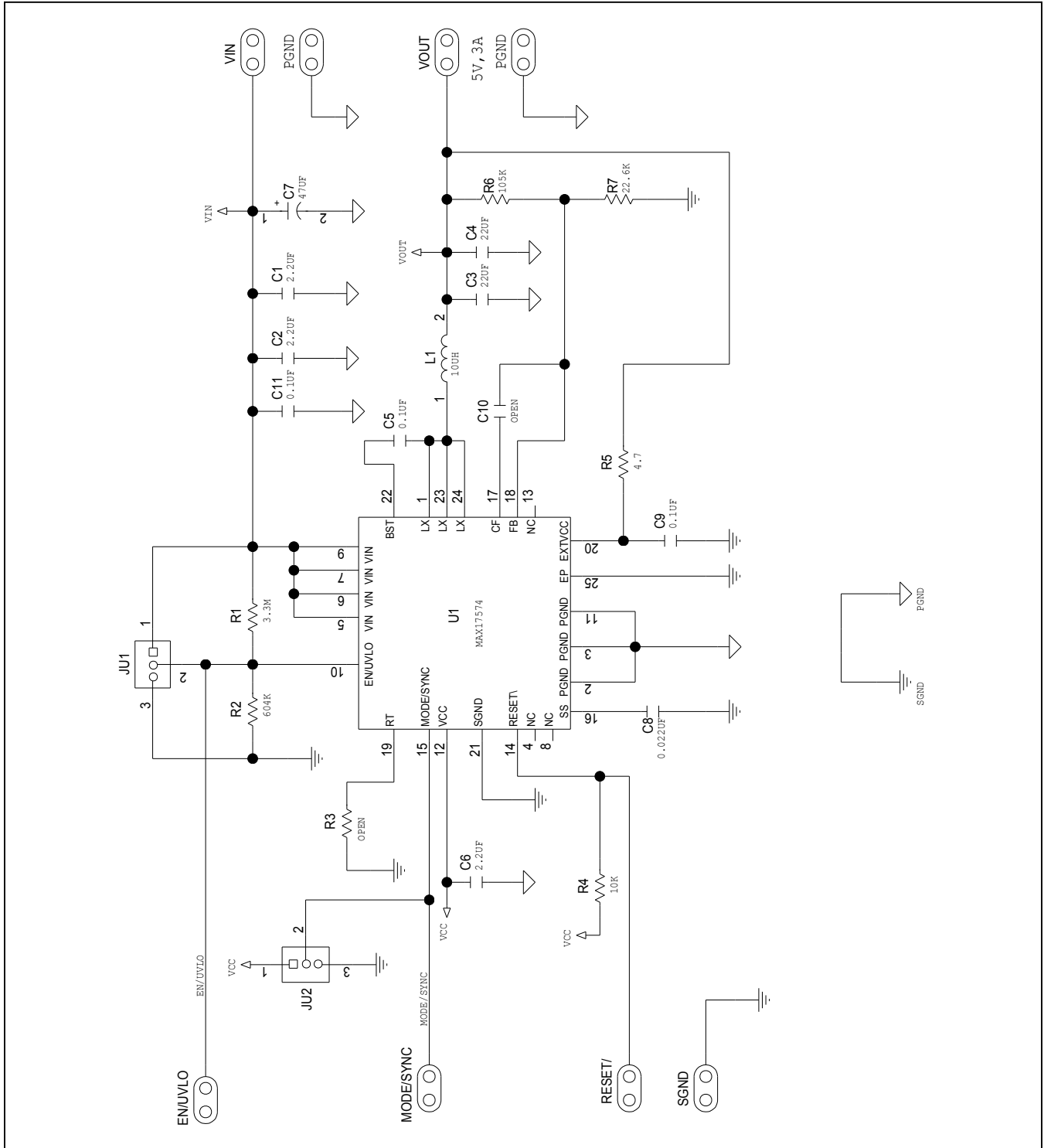

MAX17574 5V Output Evaluation Kit

Evaluates: MAX17574 in
5V Output-Voltage Application

MAX17574 5V EV System PCB Layout

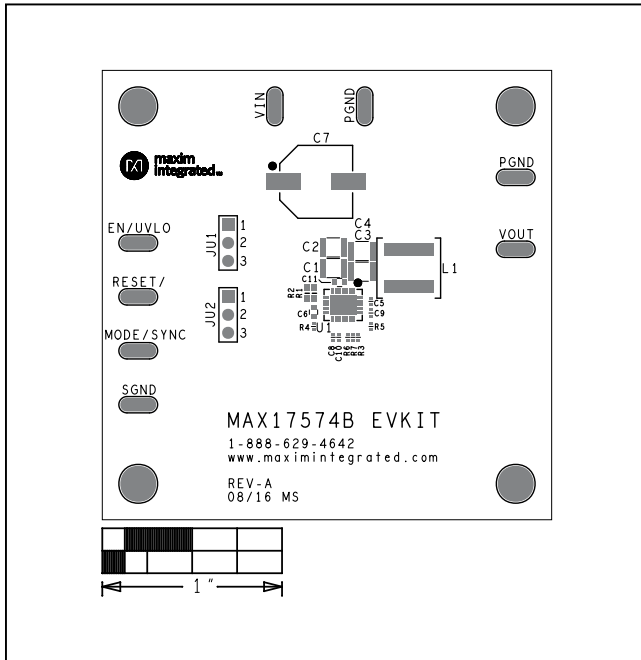

MAX17574 5V EV Kit—Top Silkscreen

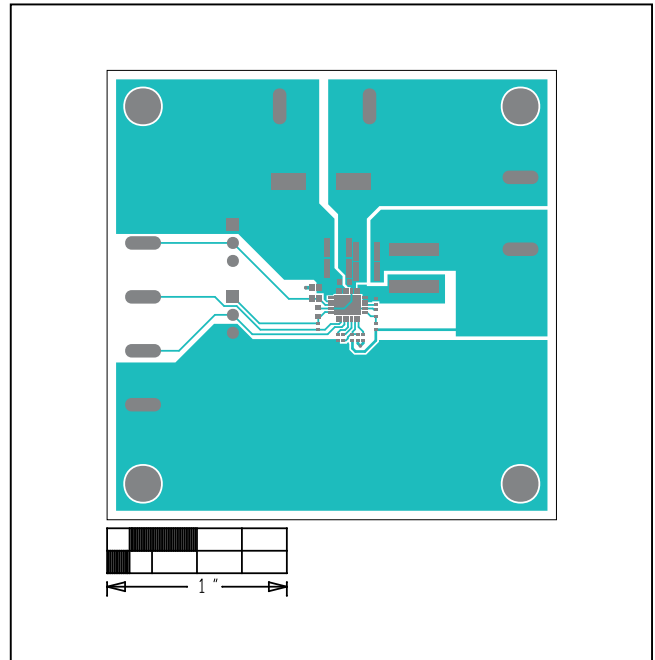

MAX17574 5V EV Kit—Top

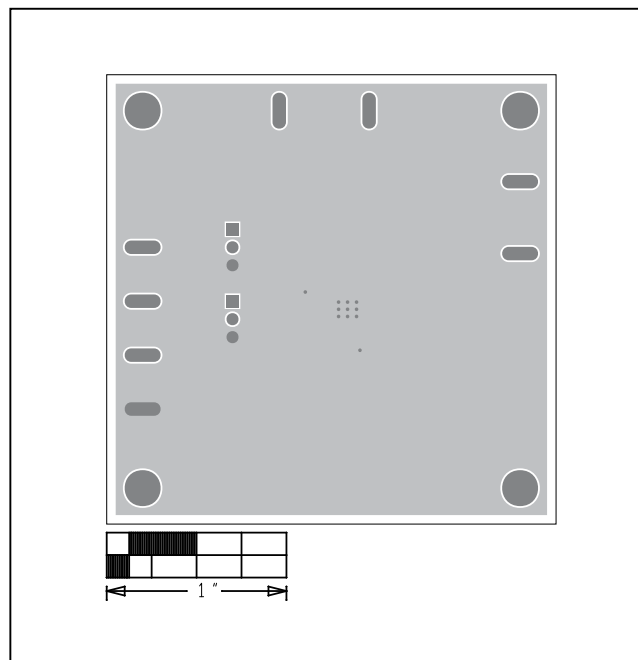

MAX17574 5V EV Kit—Layer 2 GND

MAX17574 EV System PCB Layout (continued)

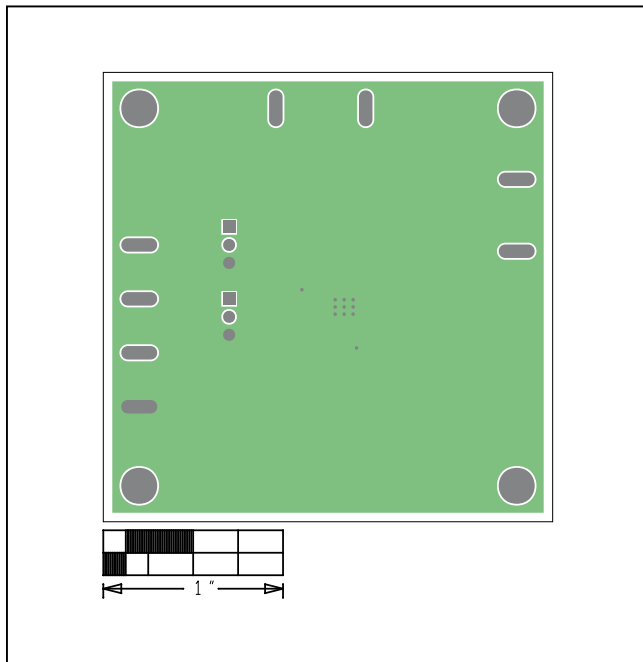

MAX17574 5V EV Kit—Layer 3 GND

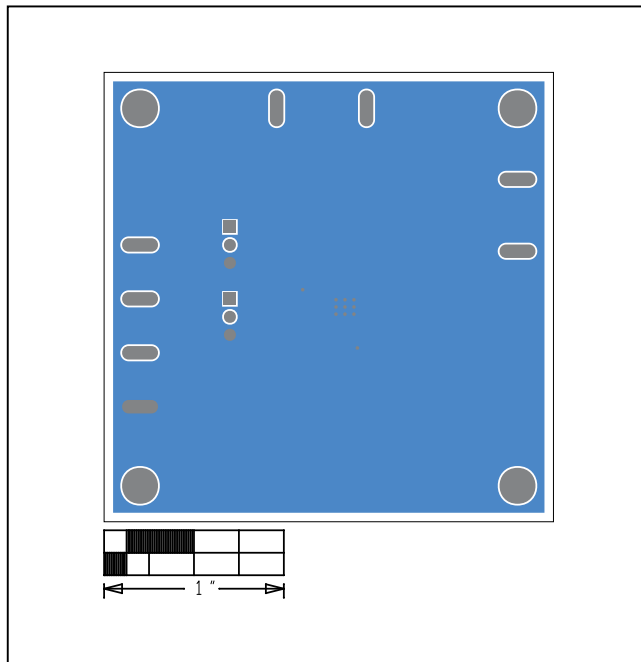

MAX17574 5V EV Kit—Bottom

Revision History

REVISION NUMBER	REVISION DATE	DESCRIPTION	PAGES CHANGED
0	12/16	Initial release	—

For pricing, delivery, and ordering information, please contact Maxim Direct at 1-888-629-4642, or visit Maxim Integrated's website at www.maximintegrated.com.

Maxim Integrated cannot assume responsibility for use of any circuitry other than circuitry entirely embodied in a Maxim Integrated product. No circuit patent licenses are implied. Maxim Integrated reserves the right to change the circuitry and specifications without notice at any time.