

PTS1812

6-60 Volt DC surface mount resettable PTC devices

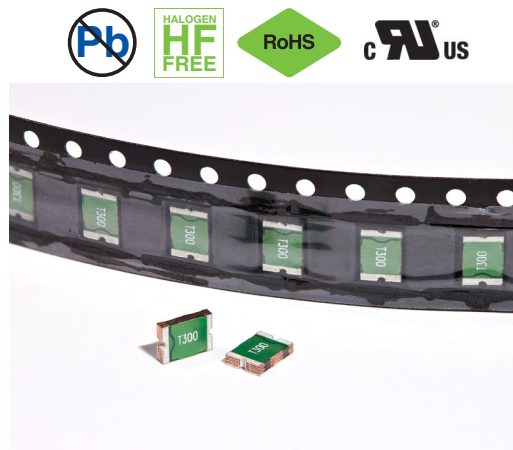

Product description

- Positive Temperature Coefficient (PTC)
- SMT resettable device
- Low resistance
- Fast time-to-trip
- Current range from 0.1A to 3.0A
- 1812 (4532 metric) compact footprint
- Halogen free, lead free, RoHS compliant

Applications

- USB peripherals
- Plug and play protection for motherboards and peripherals
- Power tools
- Battery and port protection for mobile/smart phones
- Game console port protection
- Set-top-boxes
- Tablets, notebooks, netbooks, laptops and desktops
- Rechargeable battery packs
- Digital cameras
- Appliances and white goods
- Consumer electronics

Agency information

- cURus Recognition file number: E343021
- TUV: R50192872

Product specifications

Part Number ⁷	V _{max} ¹	I _{max} ²	I _{hold} ³	I _{trip} ⁴	P _d ⁵	Time to trip (maximum)		Resistance ⁶		Agency information		
	(V _{DC})	(A)	(A)	(A)	typical (W)	(A)	(Seconds)	Initial (R _i) minimum (Ω)	Post trip (R _t) maximum (Ω)	Part marking	cURus	TUV
PTS181230V010	30	100	0.10	0.30	0.8	0.5	1.5	1.6	15	T010	x	x
PTS181260V014	60	10	0.14	0.34	0.8	1.5	0.2	1.5	6	T014	x	x
PTS181230V020	30	100	0.20	0.40	0.8	8	0.02	0.8	5	T020	x	x
PTS181216V035	16	100	0.35	0.70	0.8	8	0.1	0.32	1.5	T035	x	x
PTS181216V050	16	100	0.50	1.0	0.8	8	0.15	0.15	1	T050	x	x
PTS181213V075	13.2	100	0.75	1.5	0.8	8	0.2	0.11	0.45	T075	x	x
PTS181224V075	24	100	0.75	1.5	0.8	8	0.2	0.1	0.4	T075 24	x	x
PTS181233V075	33	20	0.75	1.5	0.8	8	0.2	0.11	0.4	T075 33	x	x
PTS18128V110	8	100	1.1	2.2	0.8	8	0.3	0.04	0.21	T110	x	x
PTS181216V110	16	100	1.1	2.2	0.8	8	0.5	0.1	0.18	T110 16	x	x
PTS181224V110	24	20	1.1	2.2	0.8	8	0.5	0.06	0.2	T110 24	x	x
PTS18126V125	6	100	1.25	2.5	0.8	8	0.4	0.05	0.14	T125	x	x
PTS181216V125	16	100	1.25	2.5	0.8	8	0.4	0.05	0.14	T125 16	x	x
PTS18128V150	8	100	1.5	3.0	0.9	8	0.3	0.04	0.11	T150	x	x
PTS181212V150	12	100	1.5	3.0	0.9	8	0.5	0.04	0.11	T150 12	x	x
PTS181224V150	24	20	1.5	3.0	0.9	8	1.5	0.04	0.12	T150 24	x	x
PTS18128V160	8	100	1.6	3.2	0.8	8	1	0.03	0.1	T160	x	x
PTS18128V200	8	100	2.0	3.5	1.2	8	2	0.02	0.06	T200	x	x
PTS18126V260	6	100	2.6	5.0	1.2	8	2.5	0.015	0.047	T260	x	x
PTS18126V300	6	100	3.0	5.0	1.2	8	4	0.012	0.04	T300	x	x

- V_{max}: Maximum continuous voltage the device can withstand without damage at current
- I_{max}: Maximum fault current the device can withstand without damage at rated voltage
- I_{hold}: Maximum current the device will pass without interruption at 23°C still air
- I_{trip}: Minimum current that will transition the device from low resistance to high resistance at 23°C still air
- P_d: Power dissipated from the device when in tripped state at 23°C still air

- R_i: Minimum resistance of the device at 23°C
R_t: Maximum resistance of the device when measured one hour post reflow at 23°C
- Part Number Definition: PTS1206xVxxx
PTS1206 = Product code and size
xV = Voltage rating (V_{max})
xxx = Ampere rating (I_{hold})

Dimensions—mm

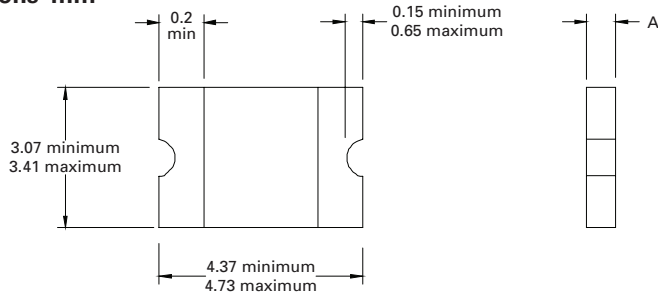

Recommended pad layout—mm

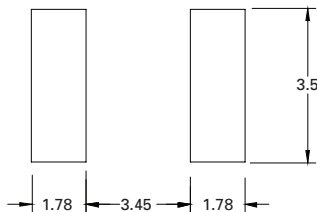

Part number	A minimum	A maximum
PTS181230V010	0.50	0.90
PTS181260V014	0.50	0.90
PTS181230V020	0.50	0.90
PTS181216V035	0.28	0.68
PTS181216V050	0.28	0.68
PTS181213V075	0.28	0.68
PTS181224V075	0.60	1.2
PTS181233V075	0.60	1.2
PTS18128V110	0.28	0.68
PTS181216V110	0.60	1.0
PTS181224V110	0.60	1.0
PTS18126V125	0.28	0.68
PTS181216V125	0.30	0.90
PTS18128V150	0.28	0.68
PTS181212V150	0.60	1.0
PTS181224V150	0.70	1.5
PTS18128V160	0.28	0.68
PTS18128V200	0.35	0.90
PTS18126V260	0.35	0.90
PTS18126V300	0.60	1.2

Time to trip curves at 23°C

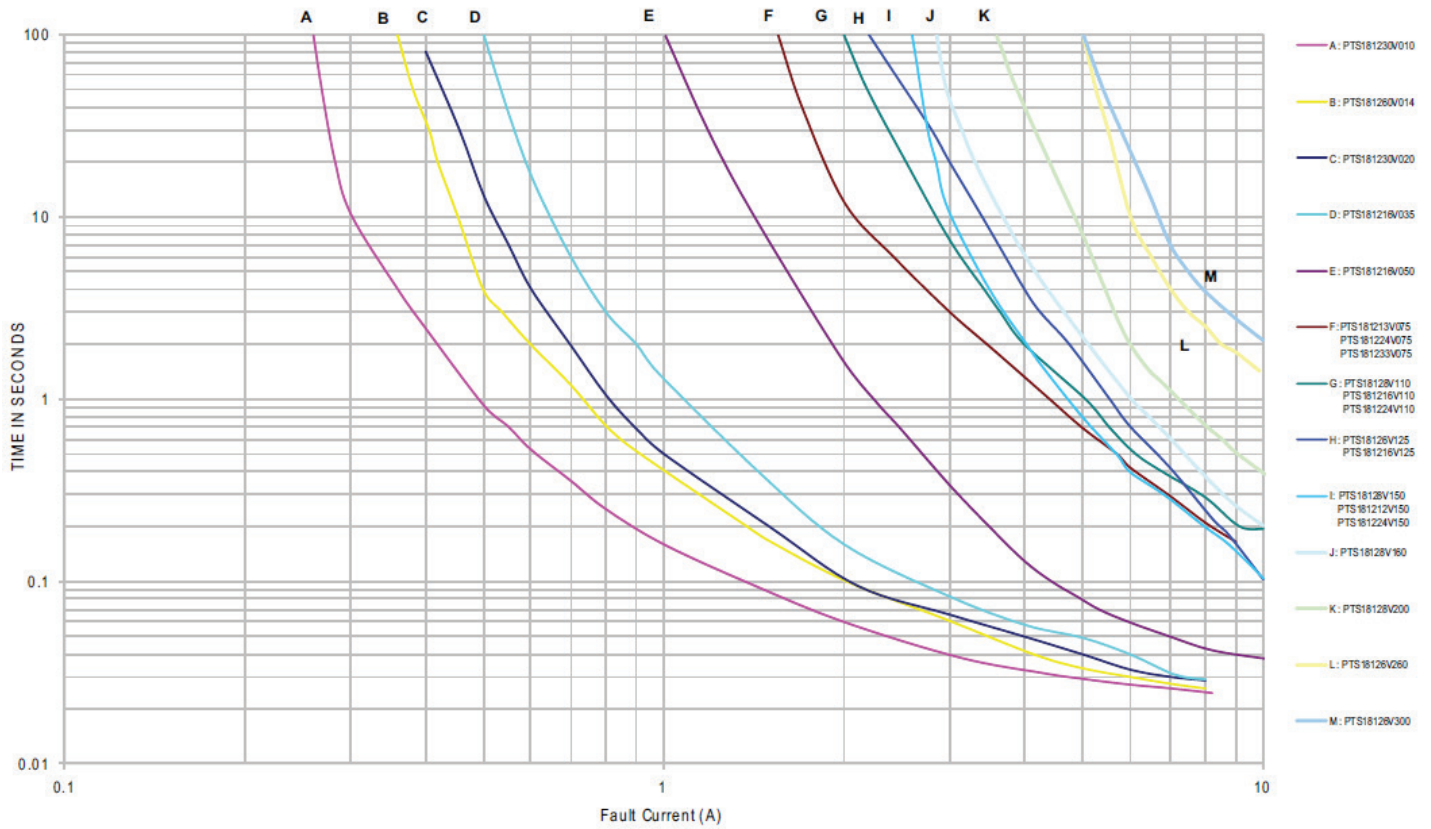

Temperature derating curve

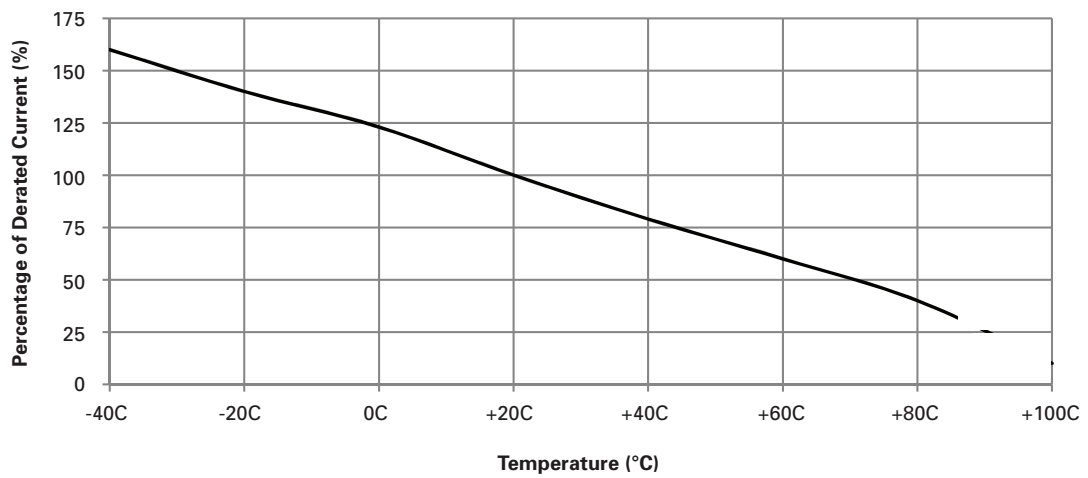

Environmental data

Operating temperature: -40°C to +85°C (with derating)
Storage temperature: -10°C to +40°C
Storage relative humidity: ≤75%
Storage condition: Keep away from corrosive atmosphere and sunlight
Storage duration: 1 year
Thermal shock: (20 cycles - 40°C to +85°C) -33% typical resistance change
Humidity: +85°C, 85% relative humidity, 1000 hours ±5% typical resistance change
Resistance to solvents: MIL-STD- 202 Method 215

Packaging information-mm

Supplied in tape and reel packaging , 2000 parts per 7.0" diameter reel

PTS181216V035, PTS181216V050, PTS181213V075, PTS18128V110, PTS18126V125, PTS18128V150, PTS18128V160, PTS18128V200

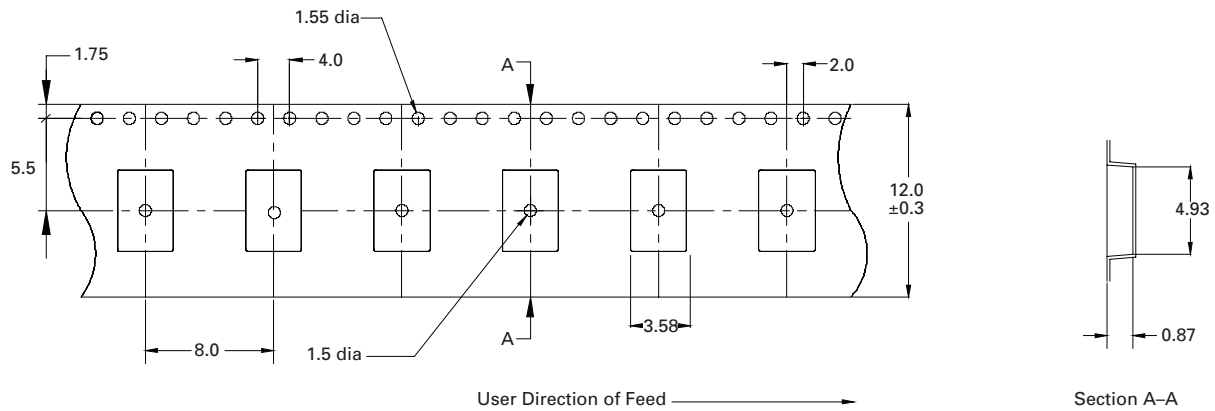

Supplied in tape and reel packaging , 1000 parts per 7.0" diameter reel

PTS181230V010, PTS181260V014, PTS181230V020, PTS181224V075, PTS181233V075, PTS181216V110, PTS181224V110, PTS181216V125, PTS181212V150, PTS181224V150, PTS18126V260, PTS18126V300

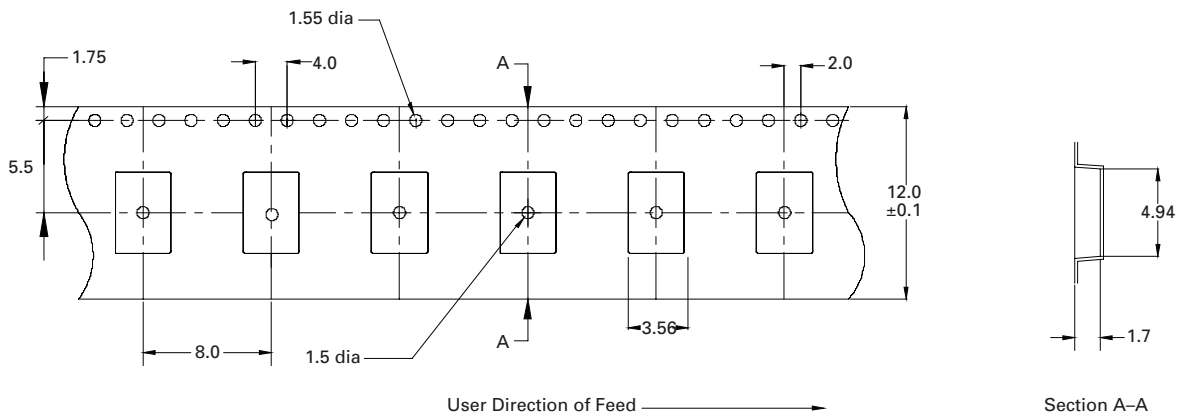

Solder reflow profile



Table 1 - Standard SnPb Solder (T_c)

Package Thickness	Volume mm ³ <350	Volume mm ³ ≥350
<2.5mm)	235°C	220°C
≥2.5mm	220°C	220°C

Table 2 - Lead (Pb) Free Solder (T_c)

Package Thickness	Volume mm ³ <350	Volume mm ³ 350 - 2000	Volume mm ³ >2000
<1.6mm	260°C	260°C	260°C
1.6 - 2.5mm	260°C	250°C	245°C
>2.5mm	250°C	245°C	245°C

Reference JEDEC J-STD-020D

Profile Feature	Standard SnPb Solder	Lead (Pb) Free Solder
Preheat and Soak		
• Temperature min. (T_{smin})	100°C	150°C
• Temperature max. (T_{smax})	150°C	200°C
• Time (T_{smin} to T_{smax}) (t_s)	60-120 Seconds	60-120 Seconds
Average ramp up rate T_{smax} to T_p	3°C/ Second Max.	3°C/ Second Max.
Liquidous temperature (T_L)	183°C	217°C
Time at liquidous (t_L)	60-150 Seconds	60-150 Seconds
Peak package body temperature (T_p)*	Table 1	Table 2
Time (t_p)** within 5 °C of the specified classification temperature (T_c)	20 Seconds**	30 Seconds**
Average ramp-down rate (T_p to T_{smax})	6°C/ Second Max.	6°C/ Second Max.
Time 25°C to Peak Temperature	6 Minutes Max.	8 Minutes Max.

* Tolerance for peak profile temperature (T_p) is defined as a supplier minimum and a user maximum.
** Tolerance for time at peak profile temperature (t_p) is defined as a supplier minimum and a user maximum.

Wave solder

Reservoir temperature: 260°C
Time in reservoir: 10 seconds maximum

Life Support Policy: Eaton does not authorize the use of any of its products for use in life support devices or systems without the express written approval of an officer of the Company. Life support systems are devices which support or sustain life, and whose failure to perform, when properly used in accordance with instructions for use provided in the labeling, can be reasonably expected to result in significant injury to the user.

Eaton reserves the right, without notice, to change design or construction of any products and to discontinue or limit distribution of any products. Eaton also reserves the right to change or update, without notice, any technical information contained in this bulletin.

Eaton
Electronics Division
1000 Eaton Boulevard
Cleveland, OH 44122
United States
www.eaton.com/elx

© 2015 Eaton
All Rights Reserved
Printed in USA
Publication No. 4398 BU-SB15275
June 2015

Eaton is a registered trademark.
All other trademarks are property of their respective owners.