

Complementary MOSFET

ELM34608AA-N

■ General Description

ELM34608AA-N uses advanced trench technology to provide excellent $R_{ds(on)}$ and low gate charge.

■ Features

- | | |
|--|--|
| N-channel | P-channel |
| • $V_{ds}=60V$ | $V_{ds}=-60V$ |
| • $I_d=4.5A$ | $I_d=-3.5A$ |
| • $R_{ds(on)} < 58m\Omega (V_{gs}=10V)$ | $R_{ds(on)} < 90m\Omega (V_{gs}=-10V)$ |
| • $R_{ds(on)} < 85m\Omega (V_{gs}=4.5V)$ | $R_{ds(on)} < 135m\Omega (V_{gs}=-4.5V)$ |

■ Maximum Absolute Ratings

$T_a=25^\circ C$. Unless otherwise noted.

| Parameter | Symbol | N-ch (Max.) | P-ch (Max.) | Unit | Note |
|--|----------------|------------------|-------------|------------|------|
| Drain-source voltage | V_{ds} | 60 | -60 | V | |
| Gate-source voltage | V_{gs} | ± 20 | ± 20 | V | |
| Continuous drain current | I_d | $T_a=25^\circ C$ | 4.5 | -3.5 | A |
| | | $T_a=70^\circ C$ | 4.0 | -3.0 | |
| Pulsed drain current | I_{dm} | 20 | -20 | A | 3 |
| Power dissipation | P_d | $T_c=25^\circ C$ | 2.0 | 2.0 | W |
| | | $T_c=70^\circ C$ | 1.3 | 1.3 | |
| Junction and storage temperature range | T_j, T_{stg} | -55 to 150 | -55 to 150 | $^\circ C$ | |

■ Thermal Characteristics

| Parameter | Symbol | Device | Typ. | Max. | Unit | Note |
|-----------------------------|-----------------|--------|------|------|--------------|------|
| Maximum junction-to-ambient | $R_{\theta ja}$ | N-ch | | 62.5 | $^\circ C/W$ | |
| Maximum junction-to-ambient | $R_{\theta ja}$ | P-ch | | 62.5 | $^\circ C/W$ | |

■ Pin configuration

SOP-8(TOP VIEW)

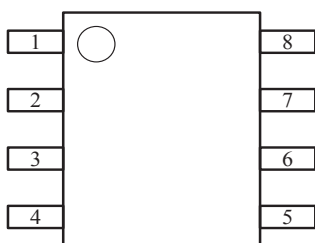

| Pin No. | Pin name |
|---------|----------|
| 1 | SOURCE1 |
| 2 | GATE1 |
| 3 | SOURCE2 |
| 4 | GATE2 |
| 5 | DRAIN2 |
| 6 | DRAIN2 |
| 7 | DRAIN1 |
| 8 | DRAIN1 |

■ Circuit

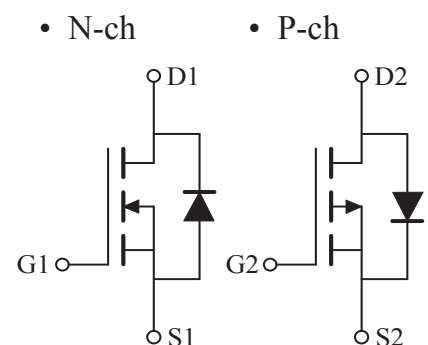

Complementary MOSFET

ELM34608AA-N

■Electrical Characteristics (N-ch)

Ta=25°C. Unless otherwise noted.

| Parameter | Symbol | Conditions | Min. | Typ. | Max. | Unit | Note |
|-----------------------------------|---------|------------------------------------|------|------|------|------|------|
| STATIC PARAMETERS | | | | | | | |
| Drain-source breakdown voltage | BVdss | Id=250μA, Vgs=0V | 60 | | | V | |
| Zero gate voltage drain current | Idss | Vds=48V, Vgs=0V | | | 1 | μA | |
| | | Vds=40V, Vgs=0V, Ta=55°C | | | 10 | | |
| Gate-body leakage current | Igss | Vds=0V, Vgs=±20V | | | ±100 | nA | |
| Gate threshold voltage | Vgs(th) | Vds=Vgs, Id=250μA | 1.0 | 1.5 | 2.5 | V | |
| On state drain current | Id(on) | Vgs=10V, Vds=5V | 20 | | | A | 1 |
| Static drain-source on-resistance | Rds(on) | Vgs=10V, Id=4.5A | | 42 | 58 | mΩ | 1 |
| | | Vgs=4.5V, Id=4A | | 55 | 85 | | |
| Forward transconductance | Gfs | Vds=10V, Id=4.5A | | 14 | | S | 1 |
| Diode forward voltage | Vsd | If=Is=1.3A, Vgs=0V | | | 1 | V | 1 |
| Max.body-diode continuous current | Is | | | | 1.3 | A | |
| Pulsed current | Ism | | | | 2.6 | A | 3 |
| DYNAMIC PARAMETERS | | | | | | | |
| Input capacitance | Ciss | Vgs=0V, Vds=25V, f=1MHz | | 650 | | pF | |
| Output capacitance | Coss | | | 80 | | pF | |
| Reverse transfer capacitance | Crss | | | 35 | | pF | |
| SWITCHING PARAMETERS | | | | | | | |
| Total gate charge | Qg | Vgs=10V, Vds=30V, Id=4.5A | | 12.0 | 16.0 | nC | 2 |
| Gate-source charge | Qgs | | | 2.4 | | nC | 2 |
| Gate-drain charge | Qgd | | | 2.6 | | nC | 2 |
| Turn-on delay time | td(on) | Vgs=10V, Vds=30V, Id=1A Rgen=6Ω | | 11 | 20 | ns | 2 |
| Turn-on rise time | tr | | | 8 | 18 | ns | 2 |
| Turn-off delay time | td(off) | | | 19 | 35 | ns | 2 |
| Turn-off fall time | tf | | | 6 | 15 | ns | 2 |

NOTE :

1. Pulse test : Pulsed width≤300μsec and Duty cycle≤2%.
2. Independent of operating temperature.
3. Pulsed width limited by maximum junction temperature.
4. Duty cycle ≤ 1%.

Complementary MOSFET

ELM34608AA-N

■ Typical Electrical and Thermal Characteristics (N-ch)

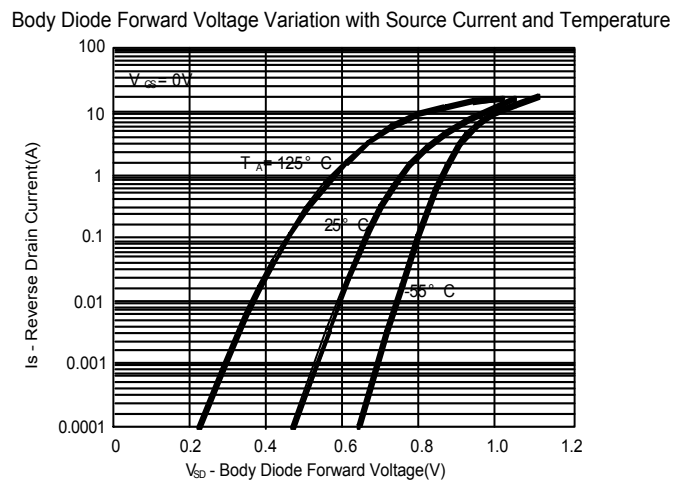
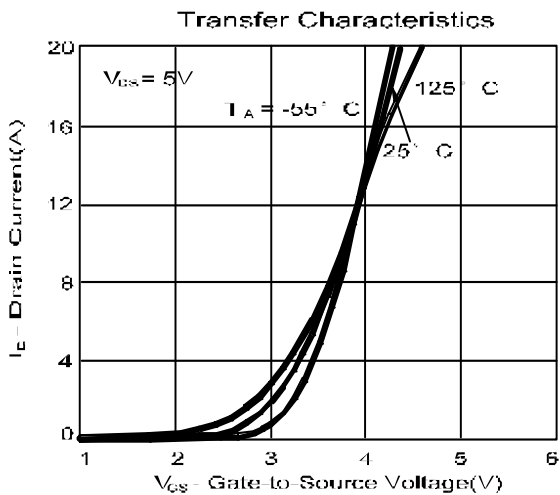
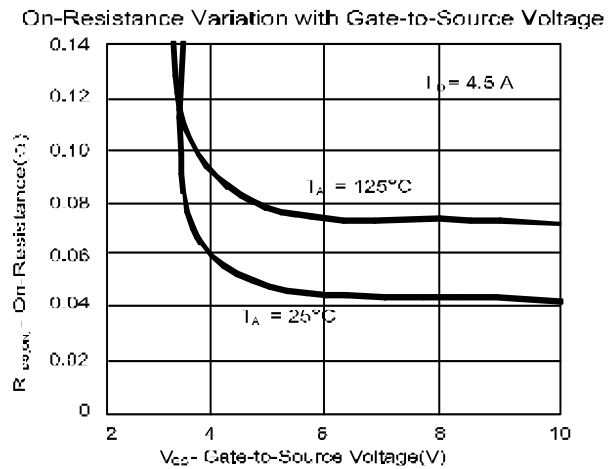
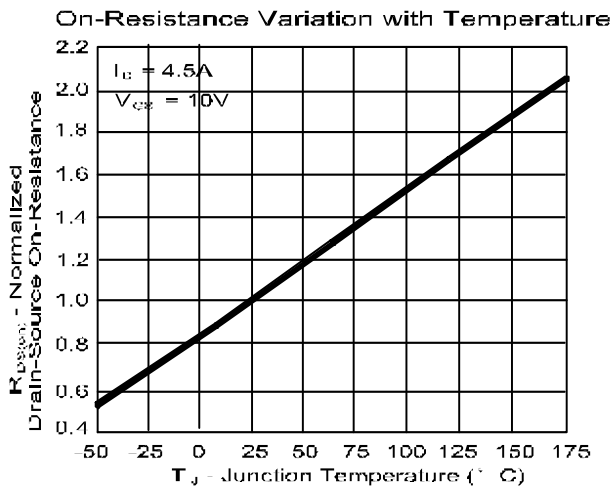
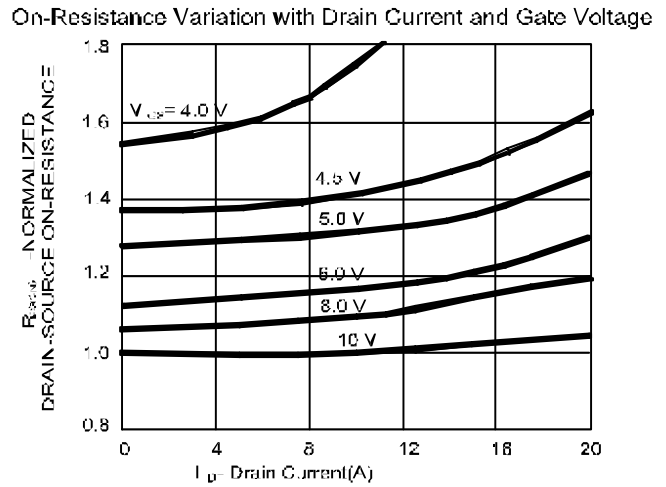
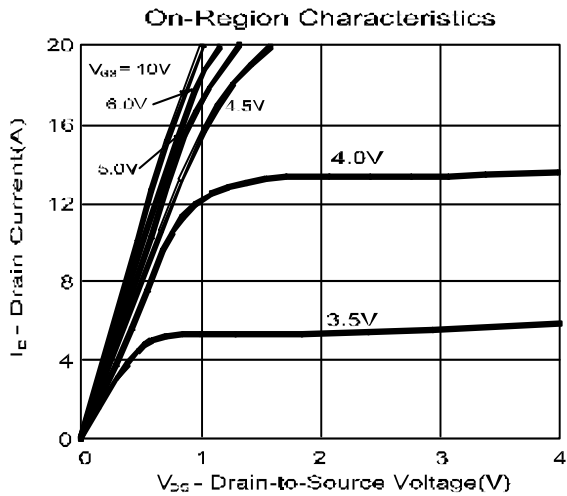

Complementary MOSFET

ELM34608AA-N

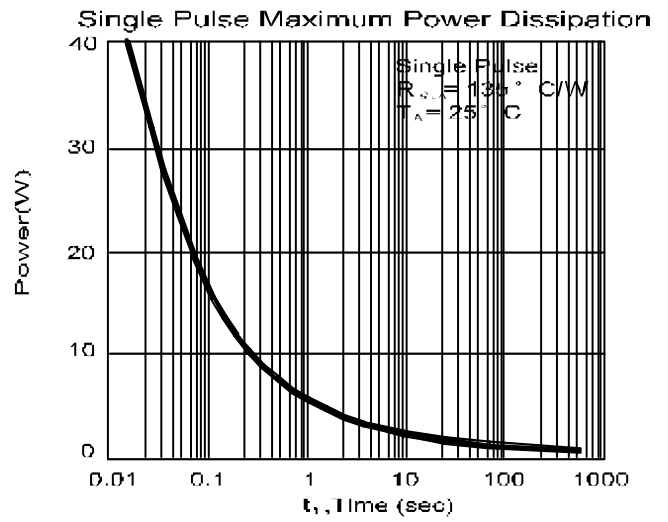
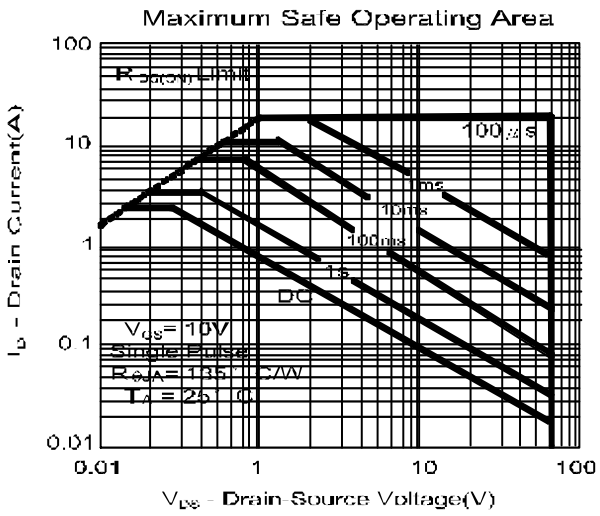
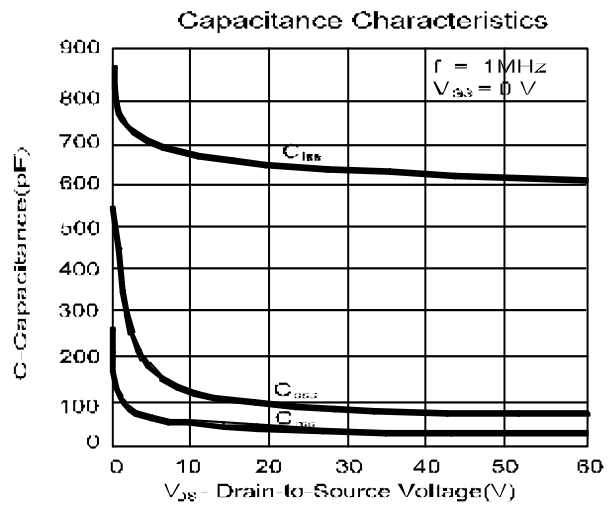
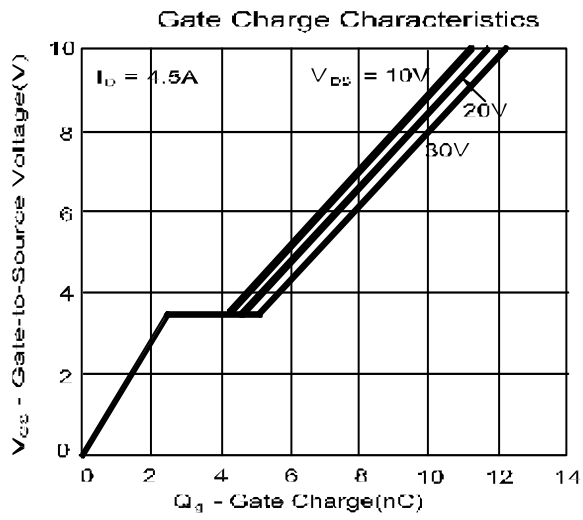

Complementary MOSFET

ELM34608AA-N

■Electrical Characteristics (P-ch)

Ta=25°C. Unless otherwise noted.

| Parameter | Symbol | Conditions | Min. | Typ. | Max. | Unit | Note |
|-----------------------------------|---------|---------------------------------------|------|------|------|------|------|
| STATIC PARAMETERS | | | | | | | |
| Drain-source breakdown voltage | BVdss | Id=-250μA, Vgs=0V | -60 | | | V | |
| Zero gate voltage drain current | Idss | Vds=-48V, Vgs=0V | | | -1 | μA | |
| | | Vds=-40V, Vgs=0V, Ta=55°C | | | -10 | | |
| Gate-body leakage current | Igss | Vds=0V, Vgs=±20V | | | ±100 | nA | |
| Gate threshold voltage | Vgs(th) | Vds=Vgs, Id=-250μA | -1.0 | -1.5 | -2.5 | V | |
| On state drain current | Id(on) | Vgs=-10V, Vds=-5V | -20 | | | A | 1 |
| Static drain-source on-resistance | Rds(on) | Vgs=-10V, Id=-3.5A | | 70 | 90 | mΩ | 1 |
| | | Vgs=-4.5V, Id=-3A | | 100 | 135 | | |
| Forward transconductance | Gfs | Vds=-5V, Id=-3.5A | | 9 | | S | 1 |
| Diode forward voltage | Vsd | If=Is=-1.3A, Vgs=0V | | | -1 | V | 1 |
| Max.body-diode continuous current | Is | | | | -1.3 | A | |
| Pulsed current | Ism | | | | -2.6 | A | 3 |
| DYNAMIC PARAMETERS | | | | | | | |
| Input capacitance | Ciss | Vgs=0V, Vds=-30V, f=1MHz | | 630 | | pF | |
| Output capacitance | Coss | | | 81 | | pF | |
| Reverse transfer capacitance | Crss | | | 33 | | pF | |
| SWITCHING PARAMETERS | | | | | | | |
| Total gate charge | Qg | Vgs=-10V, Vds=-30V Id=-3.5A | | 11.0 | 15.0 | nC | 2 |
| Gate-source charge | Qgs | | | 2.1 | | nC | 2 |
| Gate-drain charge | Qgd | | | 2.5 | | nC | 2 |
| Turn-on delay time | td(on) | Vgs=-10V, Vds=-30V Id=-1A, Rgen=6Ω | | 6 | 13 | ns | 2 |
| Turn-on rise time | tr | | | 8 | 18 | ns | 2 |
| Turn-off delay time | td(off) | | | 17 | 31 | ns | 2 |
| Turn-off fall time | tf | | | 11 | 20 | ns | 2 |

NOTE :

1. Pulse test : Pulsed width≤300μsec and Duty cycle≤2%.
2. Independent of operating temperature.
3. Pulsed width limited by maximum junction temperature.

Complementary MOSFET

ELM34608AA-N

■ Typical Electrical and Thermal Characteristics (P-ch)

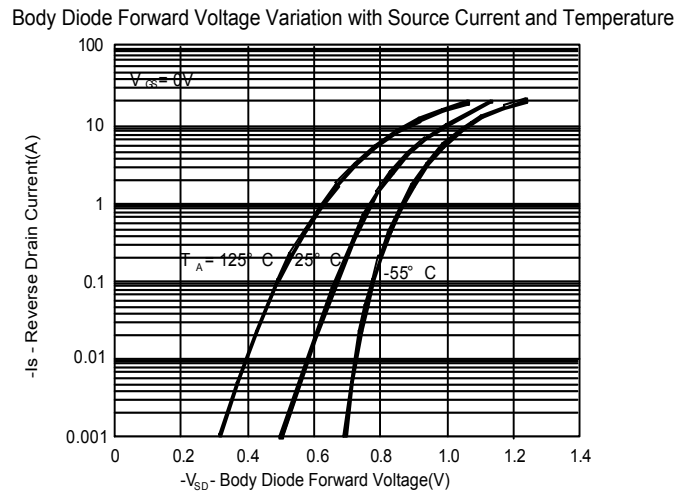
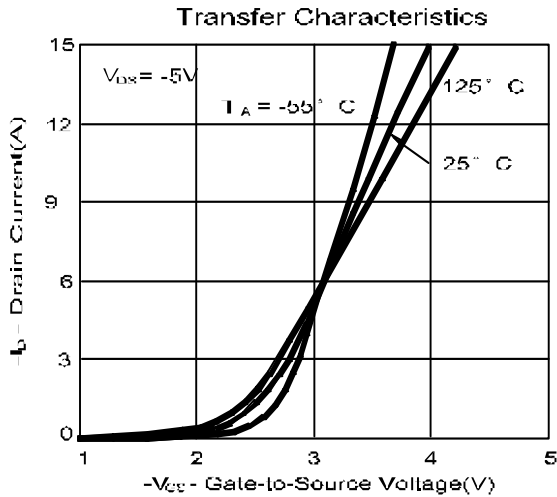
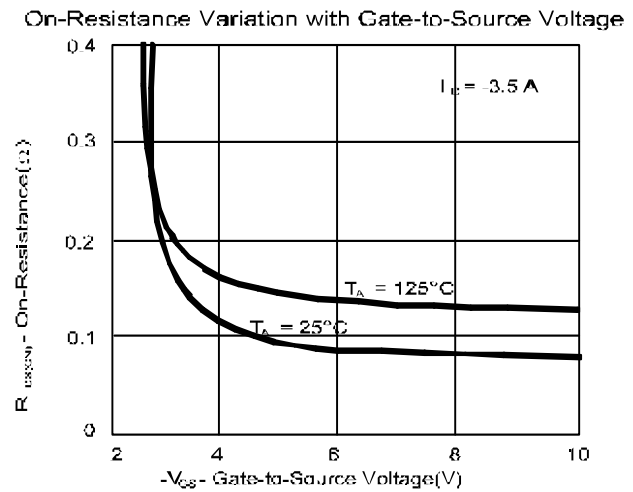
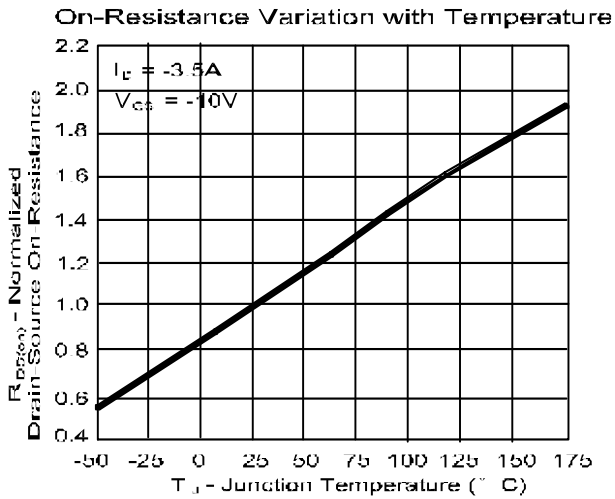
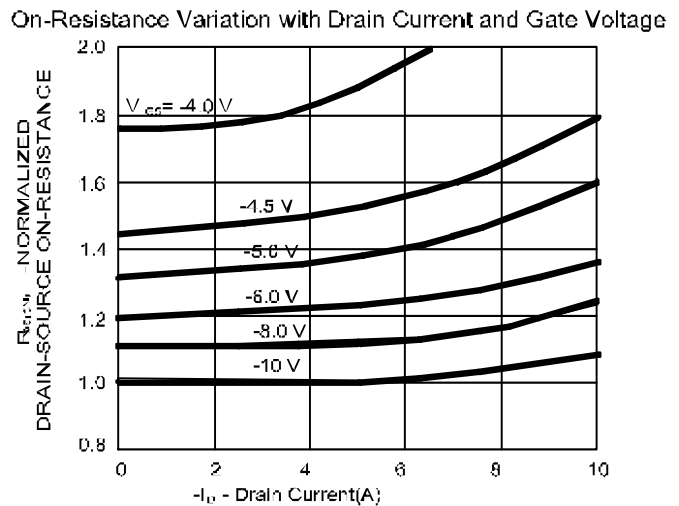
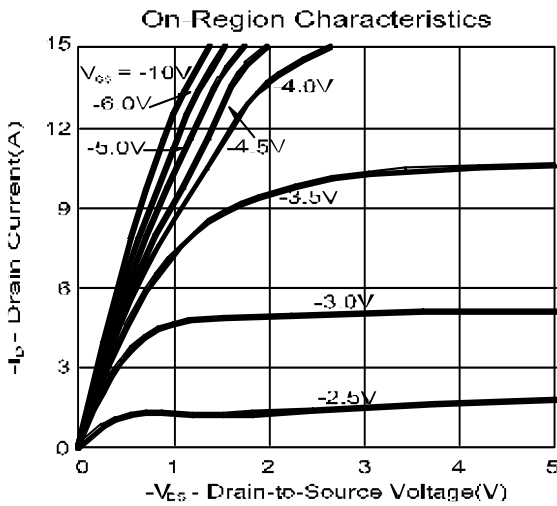

Complementary MOSFET

ELM34608AA-N

