

RoHS Compliant Product
A suffix of "-C" specifies halogen free

DESCRIPTION

SSD14N02E is the best-performance trench N-ch MOSFETs with extreme high cell density, which provides excellent $R_{DS(ON)}$ and gate charge for most of the synchronous buck converter applications.

SSD14N02E meets the RoHS and Green Product requirement with full function reliability approved.

FEATURES

- Advanced high cell density Trench technology
- Super low gate charge
- Excellent CdV/dt effect decline
- ESD protection
- Green device available

MARKING



PACKAGE INFORMATION

Package	MPQ	Leader Size
TO-252	2.5K	13 inch

TO-252(D-Pack)

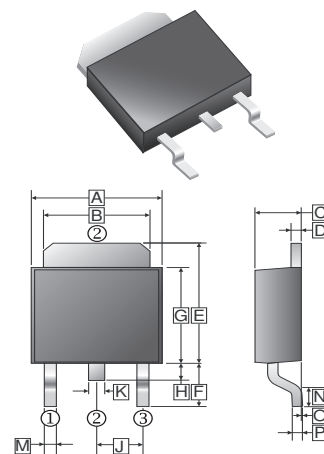

REF.	Millimeter		REF.	Millimeter	
	Min.	Max.		Min.	Max.
A	6.35	6.90	J	2.336	REF.
B	4.95	5.50	K	0.89	REF.
C	2.10	2.50	M	0.50	1.14
D	0.43	0.9	N	1.3	1.8
E	6.0	7.5	O	0	0.13
F	2.90	REF.	P	0.58	REF.
G	5.40	6.40			
H	0.60	1.20			

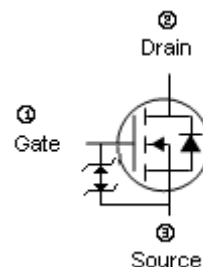

ABSOLUTE MAXIMUM RATINGS ($T_A=25^\circ\text{C}$ unless otherwise specified)

Parameter	Symbol	Rating	Unit
Drain-Source Voltage	V_{DS}	20	V
Gate-Source Voltage	V_{GS}	± 12	V
Continuous Drain Current @ $V_{GS}=4.5\text{V}^1$	I_D	$T_A=25^\circ\text{C}$	14.7
		$T_A=70^\circ\text{C}$	11.6
Pulsed Drain Current ³	I_{DM}	20	A
Total Power Dissipation @ $T_A=25^\circ\text{C}$	P_D	6.3	W
Thermal Resistance from Junction to Ambient ¹	$R_{\theta JA}$	$t \leq 10\text{sec}$	20
		Steady State	62.5
			110
Thermal Resistance from Junction to Ambient			
Operating Junction and Storage Temperature Range	T_J, T_{STG}	-55~150	$^\circ\text{C}$

ELECTRICAL CHARACTERISTICS ($T_J=25^\circ\text{C}$ unless otherwise specified)

Parameter	Symbol	Min.	Typ.	Max.	Unit	Test Condition
Drain-Source Breakdown Voltage	BV_{DSS}	20	-	-	V	$V_{GS}=0, I_D=250\mu\text{A}$
Drain-Source Leakage Current	I_{DSS}	-	-	1	μA	$V_{DS}=16\text{V}, V_{GS}=0, T_J=25^\circ\text{C}$
		-	-	30		$V_{DS}=16\text{V}, V_{GS}=0, T_J=85^\circ\text{C}$
Gate-Source Leakage Current	I_{GSS}	-	-	± 10	μA	$V_{DS}=0\text{V}, V_{GS}=\pm 10\text{V}$
Gate-Threshold Voltage	$V_{GS(th)}$	0.5	0.7	1.2	V	$V_{DS}=V_{GS}, I_D=250\mu\text{A}$
Static Drain-Source On-Resistance ²	$R_{DS(ON)}$	-	-	19.5	m Ω	$V_{GS}=4.5\text{V}, I_D=10\text{A}$
		-	-	26.5		$V_{GS}=2.5\text{V}, I_D=5\text{A}$
Input Capacitance	C_{iss}	-	630	-	pF	$V_{DS}=15\text{V}$ $V_{GS}=0$ $f=1\text{MHz}$
Output Capacitance	C_{oss}	-	105	-		
Reverse Transfer Capacitance	C_{rss}	-	100	-		
Total Gate Charge	Q_g	-	12	-	nC	$V_{DS}=10\text{V}$ $V_{GS}=4.5\text{V}$ $I_D=10\text{A}$
Gate-Source Charge	Q_{gs}	-	1.4	-		
Gate-Drain ("Miller") Charge	Q_{gd}	-	4.4	-		
Turn-on Delay Time	$T_{d(on)}$	-	5	-	nS	$V_{DD}=10\text{V}$ $V_{GS}=4.5\text{V}$ $R_G=6\Omega$ $R_L=10\Omega$ $I_D=1\text{A}$
Rise Time	T_r	-	9	-		
Turn-off Delay Time	$T_{d(off)}$	-	25	-		
Fall Time	T_f	-	5	-		
Source-Drain Diode Characteristics						
Diode Forward Voltage ²	V_{SD}	-	-	1.3	V	$I_S=1.3\text{A}, V_{GS}=0$
Continuous Source Current ^{1,4}	I_S	-	-	14.7	A	$V_G=V_D=0\text{V}, \text{Force Current}$
Pulsed Source Current ^{2,4}	I_{SM}	-	-	20	A	
Reverse Recovery Time	T_{RR}	-	16	-	nS	$I_F=10\text{A}, dI/dt=100\text{A}/\mu\text{s}, T_J=25^\circ\text{C}$
Reverse Recovery Charge	Q_{RR}	-	10	-	nC	

Notes:

- The data is tested when the surface of the device is mounted on a 1 inch² FR-4 board with 2OZ copper.
- The data is tested by the pulse: Pulse width $\leq 300\mu\text{s}$, duty cycle $\leq 2\%$.
- The Power dissipation is limited by 150°C junction temperature.
- The data is theoretically the same as I_D and I_{DM} , in real applications, the data should be limited by the total power dissipation.

CHARACTERISTIC CURVE

Output Characteristics

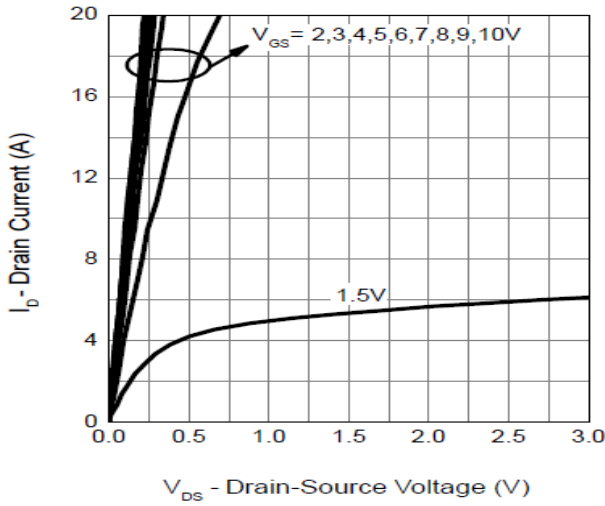

Drain-Source On Resistance

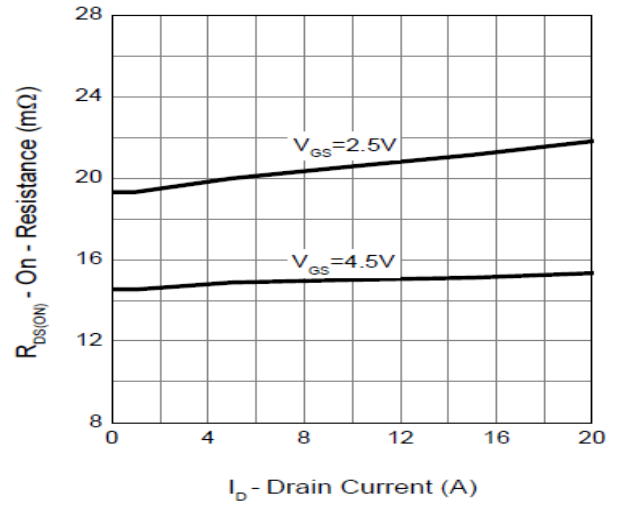

Gate-Source On Resistance

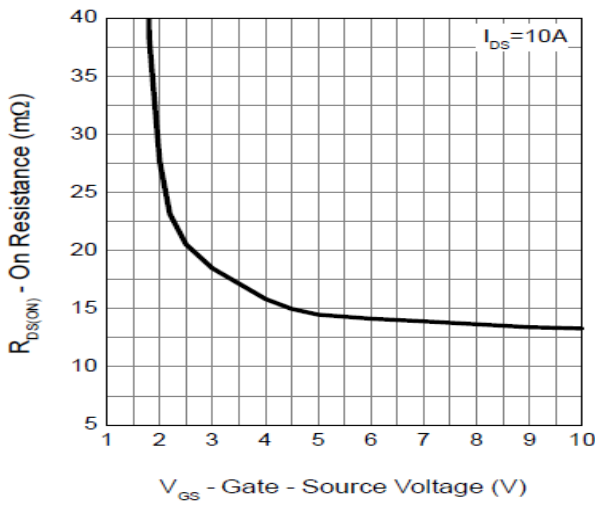

Gate Threshold Voltage

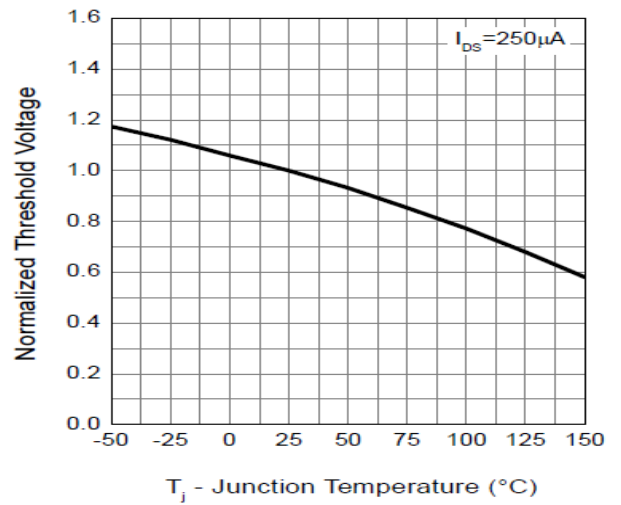

Drain-Source On Resistance

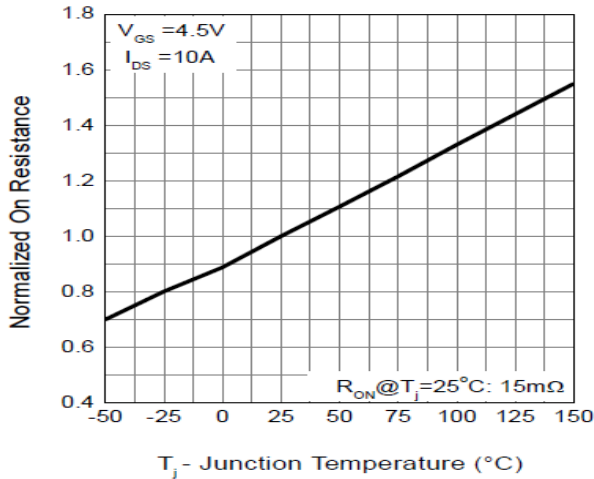

Source-Drain Diode Forward

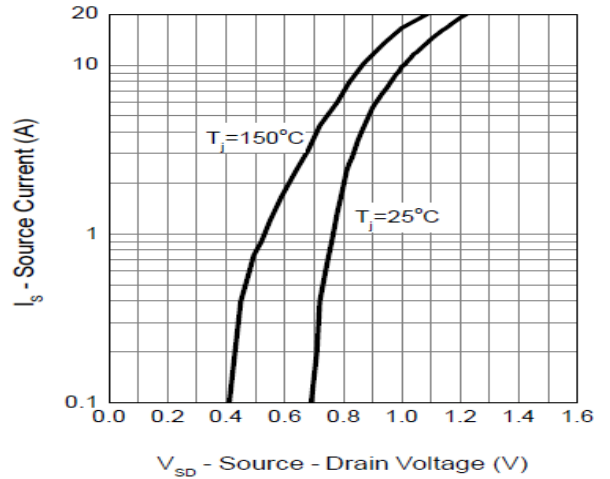

CHARACTERISTIC CURVE

Capacitance

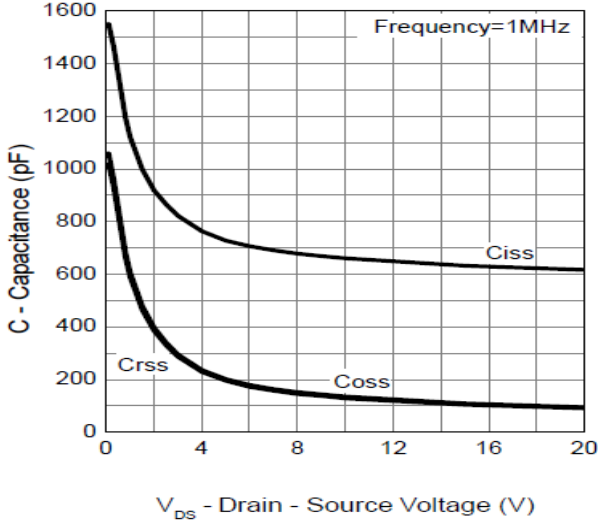

Gate Charge

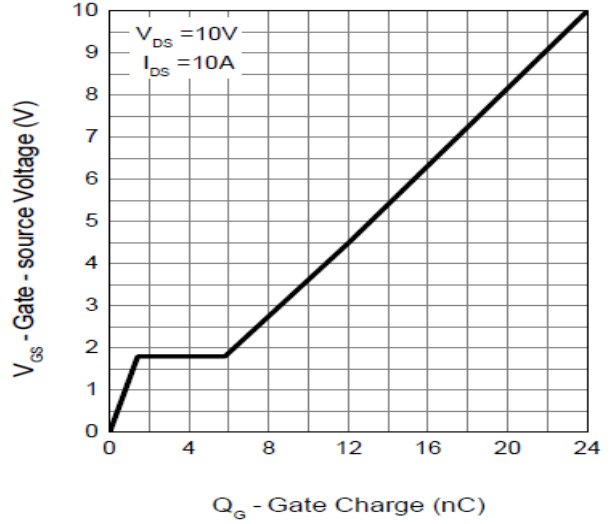

Power Dissipation

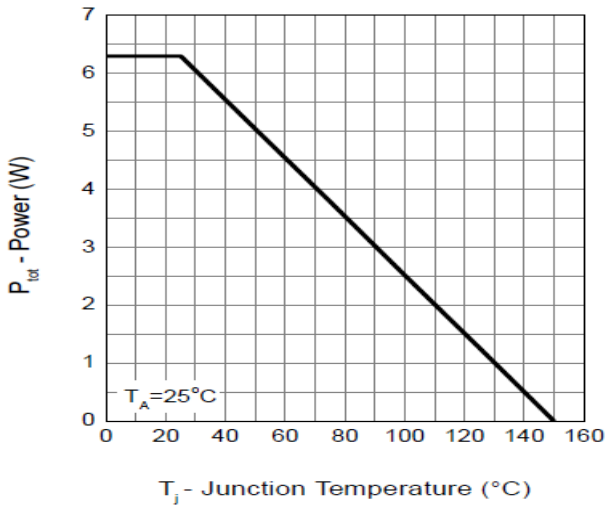

Drain Current

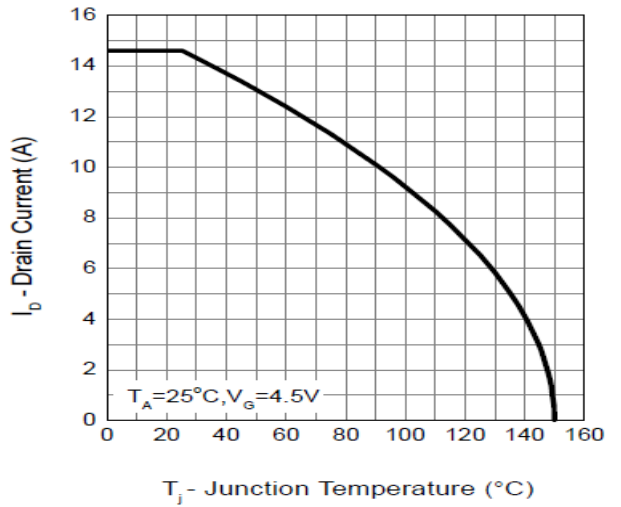

Safe Operation Area

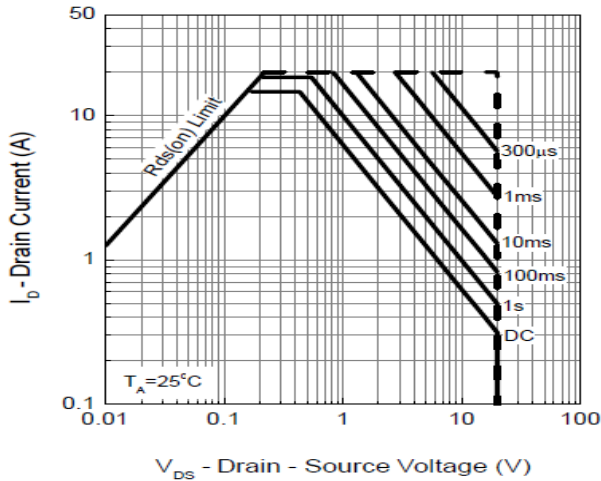

Thermal Transient Impedance

