



Thin-Film Cascadable Amplifier 2 to 500 MHz

Technical Data

UTO/UTC 515 Series

Features

- **Frequency Range: 2 to 500 MHz**
- **Medium Power Output: +15.5 dBm (Typ)**
- **Temperature Compensated**

Applications

- **IF/RF Amplification**

Description

The 515 Series is a thin-film bipolar RF amplifier that uses resistive feedback and active bias to provide temperature compensation and increased immunity to bias voltage variations. Blocking capacitors couple the RF through the amplifier. The 515 Series is available in either the TO-8 hermetic case or connected TC-1A package.

Pin Configuration UTO—TO-8U

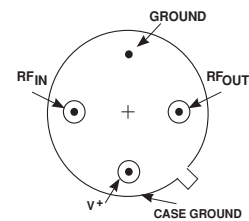

UTC—TC-1A

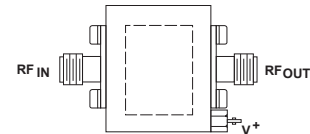

Schematic

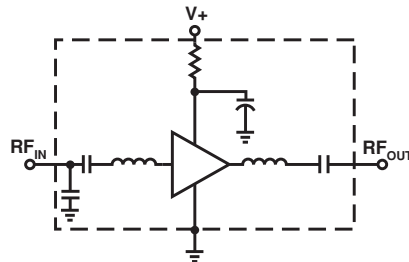

Maximum Ratings

Parameter	Maximum
DC Voltage	+17 Volts
Continuous RF Input Power	+13 dBm
Operating Case Temperature	-55 to +100°C
Storage Temperature	-62 to +150°C
"R" Series Burn-In Temperature	+100°C

Thermal Characteristics¹

θ_{JC}	75°C/W
Active Transistor Power Dissipation	600 mW
Junction Temperature Above Case Temperature	45°C
MTBF (MIL-HDBK-217E, A_{UF} @ 90°C)	1,328,000 Hrs.

Weight: (typical) UTO—2.1 grams; UTC—21.5 grams

Electrical Specifications

(Measured in 50 Ω system @ +15 VDC nominal unless otherwise noted)

Symbol	Characteristic	Typical $T_C = 25^\circ\text{C}$	Guaranteed Specifications		Unit
			$T_C = 0 \text{ to } 50^\circ\text{C}$	$T_C = -55 \text{ to } +85^\circ\text{C}$	
BW	Frequency Range	2-500	2-500	2-500	MHz
GP	Small Signal Gain (Min.)	12.5	12.0	11.0	dB
—	Gain Flatness (Max.)	± 0.2	± 0.5	± 0.7	dB
NF	Noise Figure (Max.)	4.5	5.5	6.0	dB
P_{1dB}	Power Output @ +1 dB Comp. (Min.)	+15.5	+14.0	+13.0	dBm
—	Input VSWR (Max.)	<1.3:1	2.0:1	2.0:1	—
—	Output VSWR (Max.)	<1.6:1	2.0:1	2.0:1	—
IP_3	Two Tone 3rd Order Intercept Point	+24.0	—	—	dBm
IP_2	Two Tone 2nd Order Intercept Point	+35.0	—	—	dBm
HP_2	One Tone 2nd Harmonic Intercept Point	+40.0	—	—	dBm
I_D	DC Current	65	—	—	mA

Typical Performance Over Temperature (@ +15 VDC unless otherwise noted)

Key: +25°C —
+85°C - -
-55°C = =

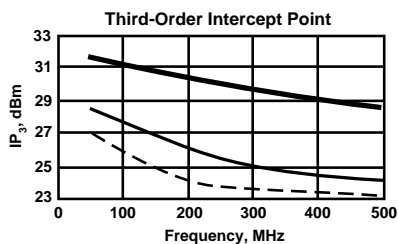
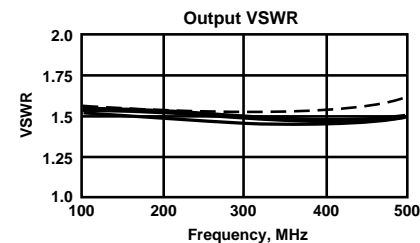
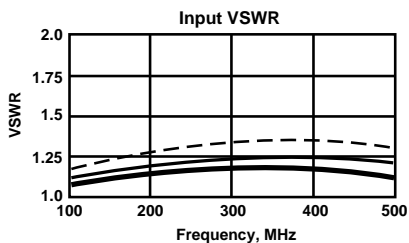
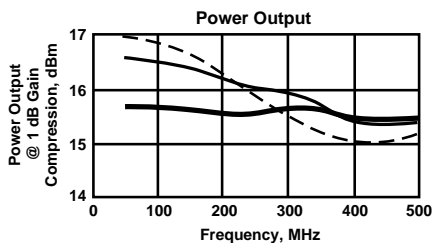
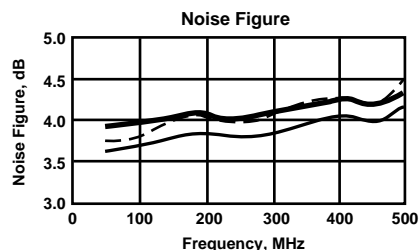
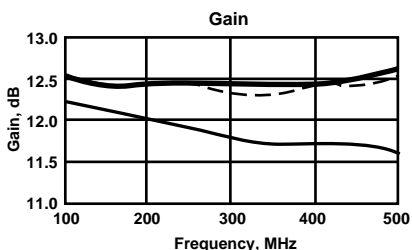

Automatic Network Analyzer Measurements (Typical production unit @ +25°C ambient)**Numerical Readings****Bias = 15.00 Volts**

FREQUENCY MHz	VSWR IN	GAIN dB	PHASE DEGREES	PHASE DEV	GROUP DELAY ns	VSWR OUT	ISOLATION dB
100.0	1.21	12.87	152.97	-.70	—	1.30	21.72
150.0	1.20	12.86	139.61	-.60	.73	1.31	21.72
200.0	1.17	12.70	126.69	-.05	.72	1.31	21.69
250.0	1.14	12.70	113.72	.44	.72	1.33	21.67
300.0	1.11	12.64	100.88	1.06	.73	1.36	21.59
350.0	1.10	12.61	87.30	.95	.77	1.40	21.50
400.0	1.11	12.59	73.33	.45	.78	1.46	21.47
450.0	1.16	12.63	59.29	-.12	.80	1.55	21.40
500.0	1.25	12.71	44.50	-1.44	.83	1.67	21.39
550.0	1.37	12.76	29.34	—	.87	1.84	21.47
600.0	1.55	12.82	13.21	—	.98	2.09	21.63

LINEARIZATION RANGE: 100.0 to 500.0 MHz

S-Parameters**Bias = 15.00 Volts**

FREQUENCY MHz	S ₁₁		S ₂₁		S ₁₂		S ₂₂	
	Mag	Ang	dB	Ang	dB	Ang	Mag	Ang
100.00	.112	-18.6	13.16	151.4	-21.51	-14.1	.129	164.5
200.00	.090	-36.8	12.98	127.3	-21.51	-30.4	.133	146.1
300.00	.059	-42.3	12.97	100.2	-21.21	-47.6	.153	123.9
400.00	.036	5.2	12.88	72.5	-21.31	-67.5	.185	98.1
500.00	.094	42.2	12.84	44.0	-21.21	-90.9	.248	71.4
600.00	.208	37.1	12.86	12.7	-21.31	-115.5	.347	40.9
700.00	.408	20.4	12.85	-24.7	-22.38	-146.1	.487	7.2
800.00	.680	-5.2	11.30	-70.2	-25.68	-178.5	.549	-25.8
900.00	.880	-37.3	7.50	-115.2	-30.75	167.8	.523	-48.5
1000.00	.927	-61.4	2.54	-143.1	-33.15	166.8	.554	-58.6

Product Options

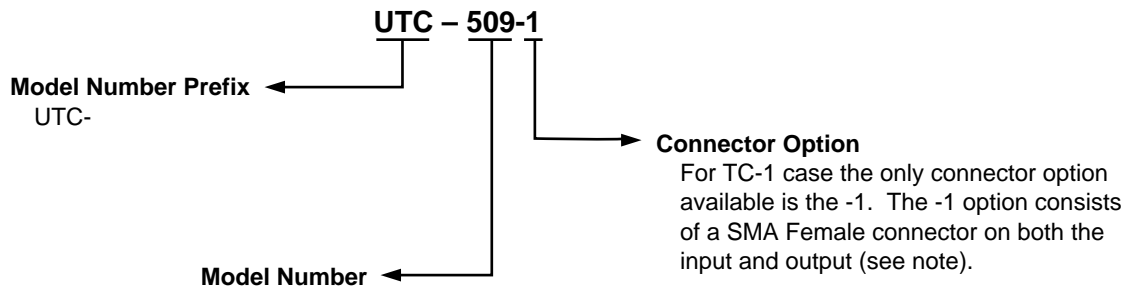
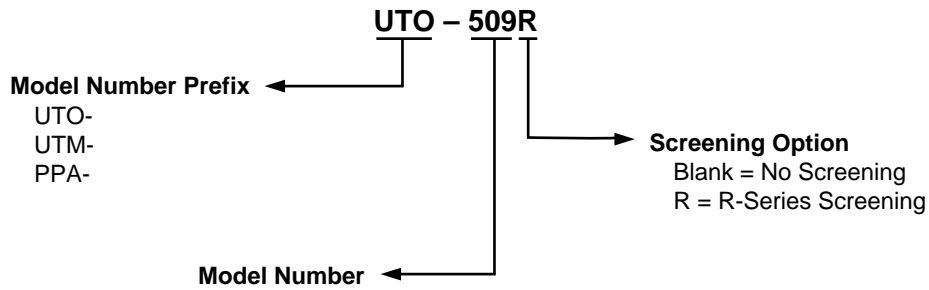

Note: R-Series screening is not available in the TC-1 case as the case is non-hermetic.

**Case Drawings
TO-8U**

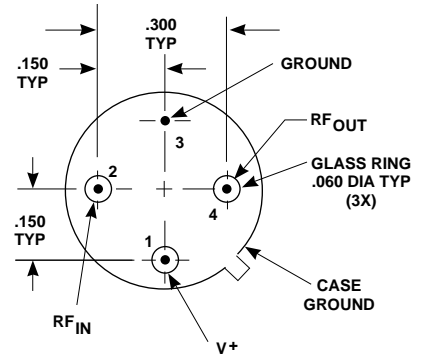
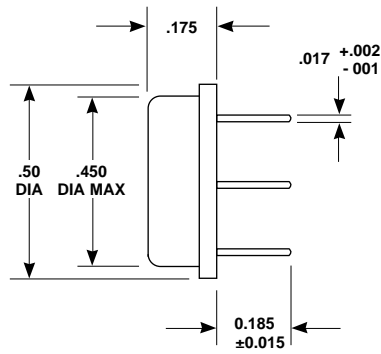
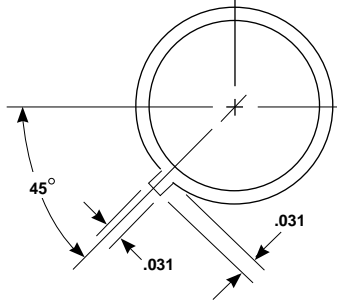

APPROXIMATE WEIGHT 2.1 GRAMS

- NOTES (UNLESS OTHERWISE SPECIFIED):**
 1. DIMENSIONS ARE SPECIFIED IN INCHES
 2. TOLERANCES: xx $\pm .02$
 xxx $\pm .010$

TC-1A

