

# High Efficiency Buck-Boost Regulator with 4.5A Switches

## ISL91110

The [ISL91110](#) is a high-current buck-boost switching regulator for systems using new battery chemistries. It uses Intersil's proprietary buck-boost algorithm to maintain voltage regulation while providing excellent efficiency and very low output voltage ripple when the input voltage is close to the output voltage.

The ISL91110 is capable of delivering at least 2A continuous output current ( $V_{OUT} = 3.3V$ ) over a battery voltage range of 2.5V to 4.35V. This maximizes the energy utilization of advanced single-cell Li-ion battery chemistries that have significant capacity left at voltages below the system voltage. Its fully synchronous low ON-resistance 4-switch architecture and a low quiescent current of only 35µA optimize efficiency under all load conditions.

The ISL91110 supports standalone applications with a fixed 3.3V or 3.5V output voltage or adjustable output voltage with an external resistor divider. Output voltages as low as 1.0V or as high as 5.2V are supported.

The ISL91110 is available in a 25-bump, 0.4mm pitch WLCSP (2.33mmx2.07mm) and a 2.5MHz switching frequency, which further reduces the size of external components.

## Features

- Accepts input voltages above or below regulated output voltage
- Automatic and seamless transitions between buck and boost modes
- Input voltage range: 1.8V to 5.5V
- Output current: up to 2A ( $P_{VIN} = 2.5V, V_{OUT} = 3.3V$ )
- Burst current: up to 3A ( $P_{VIN} = 3V, V_{OUT} = 3.3V, t_{ON} < 600\mu s, t = 4.6ms$ )
- High efficiency: up to 96%
- 35µA quiescent current maximizes light-load efficiency
- 2.5MHz switching frequency minimizes external component size
- Fully protected for short-circuit, over-temperature, and undervoltage
- Small 2.33mmx2.07mm WLCSP

## Applications

- Brownout free system voltage for smartphones and tablet PCs
- Wireless communication devices
- 2G/3G/4G RF power amplifiers

## Related Literature

- [AN1912](#) "ISL91110IIN-EVZ, ISL91110I2A-EVZ, ISL91110I1A-EVZ Evaluation Boards"

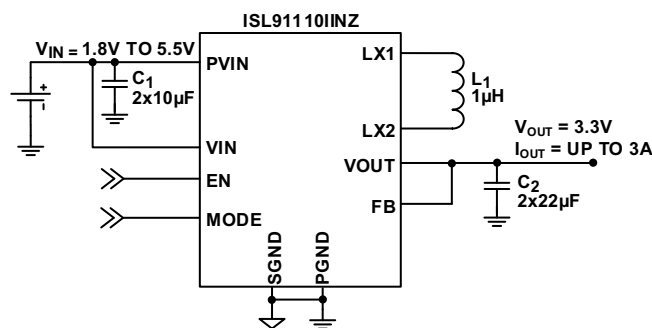

NOTE: Confirm with Intersil Applications Engineer for any deviation from above circuit

FIGURE 1. TYPICAL APPLICATION:  $V_{OUT} = 3.3V$

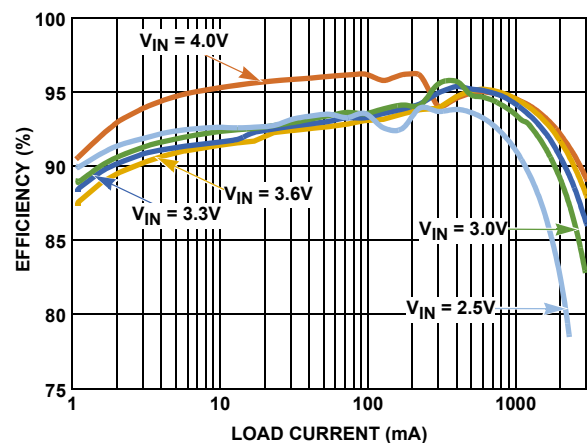

FIGURE 2. EFFICIENCY:  $V_{OUT} = 3.3V, T_A = +25^\circ C$

Block Diagram

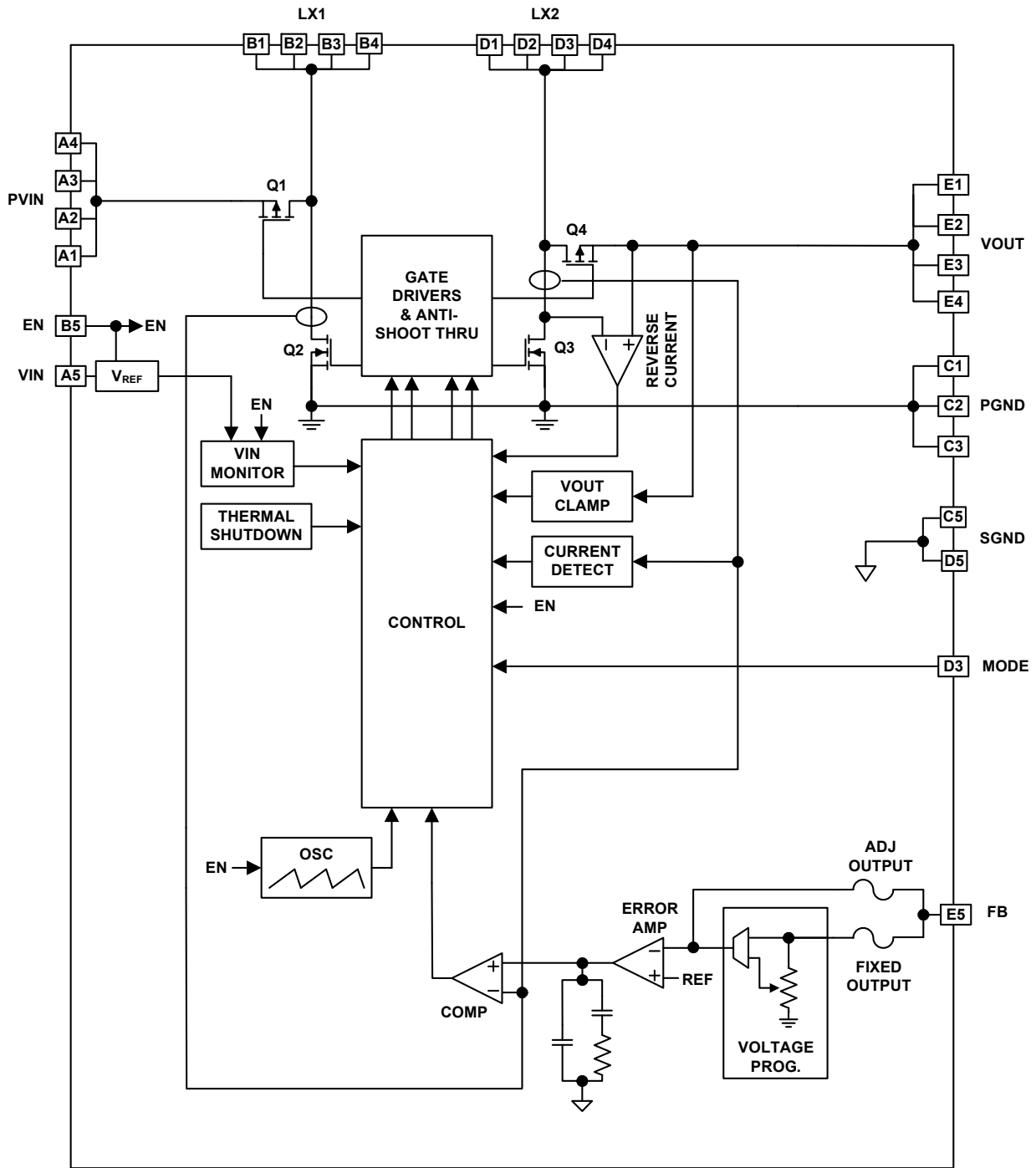
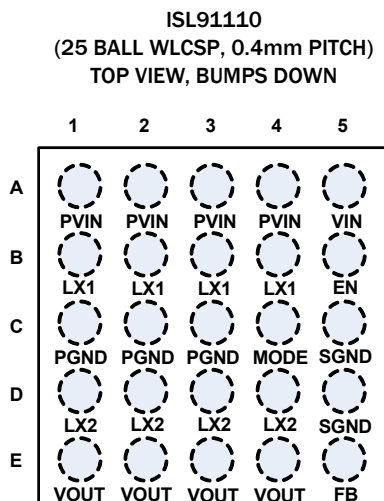

FIGURE 3. BLOCK DIAGRAM

# ISL91110

## Pin Configuration



## Pin Descriptions

| PIN #          | PIN NAMES | DESCRIPTION   |
|----------------|-----------|---|
| A1, A2, A3, A4 | PVIN      | Power input; Range: 1.8V to 5.5V. Connect 2x10µF capacitors to PGND.  |
| B1, B2, B3, B4 | LX1       | Inductor connection, input side   |
| C1, C2, C3     | PGND      | Power ground for high switching current   |
| D1, D2, D3, D4 | LX2       | Inductor connection, output side  |
| E1, E2, E3, E4 | VOUT      | Buck-boost regulator output; Connect 2x22µF capacitors to PGND.   |
| C4             | MODE      | Logic input, HIGH for auto PFM mode. LOW for forced PWM operation. Also, this pin can be used with an external clock sync input. Range: 2.75MHz to 3.25MHz. |
| A5             | VIN       | Supply input; Range: 1.8V to 5.5V.  |
| B5             | EN        | Logic input, drive HIGH to enable device.   |
| C5, D5         | SGND      | Analog ground pin   |
| E5             | FB        | Voltage feedback pin  |

## Ordering Information

| PART NUMBER<br>(Notes 1, 2, 3) | PART MARKING                      | OUTPUT VOLTAGE (V) | TAPE AND REEL OPTIONS | TEMP RANGE (°C) | PACKAGE (RoHS Compliant) | PKG. DWG. # |
|--------------------------------|-----------------------------------|--------------------|-----------------------|-----------------|--------------------------|-------------|
| ISL91110IINZ-T                 | 110N                              | 3.3                | 3k                    | -40 to +85      | 25 Ball WLCSP            | W5x5.25E    |
| ISL91110IINZ-T7A               | 110N                              | 3.3                | 250                   | -40 to +85      | 25 Ball WLCSP            | W5x5.25E    |
| ISL91110I2AZ-T                 | 102A                              | 3.5                | 3k                    | -40 to +85      | 25 Ball WLCSP            | W5x5.25E    |
| ISL91110I2AZ-T7A               | 102A                              | 3.5                | 250                   | -40 to +85      | 25 Ball WLCSP            | W5x5.25E    |
| ISL91110IIAZ-T                 | 110A                              | ADJ                | 3k                    | -40 to +85      | 25 Ball WLCSP            | W5x5.25E    |
| ISL91110IIAZ-T7A               | 110A                              | ADJ                | 250                   | -40 to +85      | 25 Ball WLCSP            | W5x5.25E    |
| ISL91110IIA-EVZ                | Evaluation Board for ISL91110IIAZ |                    |                       |                 |                          |             |

### NOTES:

- Please refer to [TB347](#) for details on reel specifications.
- These Intersil Pb-free WLCSP and BGA packaged products employ special Pb-free material sets; molding compounds/die attach materials and SnAgCu - e1 solder ball terminals, which are RoHS compliant and compatible with both SnPb and Pb-free soldering operations. Intersil Pb-free WLCSP and BGA packaged products are MSL classified at Pb-free peak reflow temperatures that meet or exceed the Pb-free requirements of IPC/JEDEC J STD-020.
- For Moisture Sensitivity Level (MSL), please see product information page for [ISL91110](#). For more information on MSL please see techbrief [TB363](#).

TABLE 1. KEY DIFFERENCES BETWEEN FAMILY OF PARTS

| PART NUMBER | PEAK CURRENT LIMIT | r <sub>DS(ON)</sub> PFET | r <sub>DS(ON)</sub> NFET | HICCUP MODE | PACKAGE                   | THERMAL RESISTANCE     |
|-------------|--------------------|--------------------------|--------------------------|-------------|---------------------------|------------------------|
| ISL91110    | 4.5A               | 40mΩ                     | 30mΩ                     | Yes         | 25-bump 2.33x2.07mm WLCSP | θ <sub>JB</sub> 13 C/W |
| ISL91110IR  | 5.4A               | 47mΩ                     | 40mΩ                     | No          | 20 Ld 4x4mm TQFN          | θ <sub>JC</sub> 4 C/W  |

# ISL91110

## Absolute Maximum Ratings

|  |               |
|--|---------------|
| PVIN, VIN  | -0.3V to 6.5V |
| LX1, LX2   | -0.3V to 6.5V |
| FB (Adjustable Version)                          | -0.3V to 2.7V |
| FB (Fixed V <sub>OUT</sub> Versions)             | -0.3V to 6.5V |
| GND, PGND  | -0.3V to 0.3V |
| All Other Pins                                   | -0.3V to 6.5V |
| ESD Rating                                       |               |
| Human Body Model (Tested per JESD22-A114E)       | 3kV           |
| Machine Model (Tested per JESD22-A115-A)         | 250V          |
| Latch-Up (Tested per JESD-78B; Class 2, Level A) | 100mA         |

## Thermal Information

|                                    |                           |                      |
|------------------------------------|---------------------------|----------------------|
| Thermal Resistance (Typical)       | $\theta_{JA}$ (°C/W)      | $\theta_{JB}$ (°C/W) |
| 25 Ball WLCSP Package (Notes 4, 5) | 66                        | 13                   |
| Maximum Junction Temperature       | +125°C                    |                      |
| Storage Temperature Range          | -65°C to +150°C           |                      |
| Pb-Free Reflow Profile             | see <a href="#">TB493</a> |                      |

## Recommended Operating Conditions

|   |                |
|---|----------------|
| Ambient Temperature Range   | -40°C to +85°C |
| Supply Voltage Range  | 1.8V to 5.5V   |
| Max Load Current (V <sub>IN</sub> = 2.5V V <sub>OUT</sub> = 3.3V)                                     | 2ADC           |
| Max Load Current (V <sub>IN</sub> = 3.0V V <sub>OUT</sub> = 3.3V, t <sub>ON</sub> = 600µs, t = 4.6ms) | 3A             |

**CAUTION:** Do not operate at or near the maximum ratings listed for extended periods of time. Exposure to such conditions may adversely impact product reliability and result in failures not covered by warranty.

### NOTES:

- $\theta_{JA}$  is measured in free air with the component mounted on a high effective thermal conductivity test board with “direct attach” features. See Tech Brief [TB379](#).
- For  $\theta_{JB}$ , the board temp is taken on the board near the edge of the package, on a trace at the middle of one side. See Tech Brief [TB379](#).

**Analog Specifications** V<sub>IN</sub> = V<sub>PVIN</sub> = V<sub>EN</sub> = 3.6V, V<sub>OUT</sub> = 3.3V, L1 = 1µH, C1 = 2x10µF, C2 = 2x22µF, T<sub>A</sub> = +25°C. **Boldface limits apply across the operating temperature range, -40°C to +85°C and input voltage range (1.8V to 5.5V) unless specified otherwise.**

| SYMBOL                                  | PARAMETER                                      | TEST CONDITIONS   | MIN<br>(Note 6) | TYP<br>(Note 7) | MAX<br>(Note 6) | UNIT  |
|---|--|---|-----------------|-----------------|-----------------|-------|
| <b>POWER SUPPLY</b>                     |  |   |                 |                 |                 |       |
| V <sub>IN</sub>                         | Input Voltage Range                            |   | <b>1.8</b>      |                 | <b>5.5</b>      | V     |
| V <sub>UVLO</sub>                       | V <sub>IN</sub> Undervoltage Lockout Threshold | Rising  |                 | 1.725           | <b>1.775</b>    | V     |
|   |  | Falling   | <b>1.550</b>    | 1.650           |                 | V     |
| I <sub>VIN</sub>                        | V <sub>IN</sub> Supply Current                 | PFM mode, no external load on V <sub>OUT</sub> (Note 8)                                   |                 | 35              | <b>60</b>       | µA    |
| I <sub>SD</sub>                         | V <sub>IN</sub> Supply Current, Shutdown       | EN = GND, V <sub>IN</sub> = 3.6V  |                 | 0.05            | <b>1.00</b>     | µA    |
| <b>OUTPUT VOLTAGE REGULATION</b>        |  |   |                 |                 |                 |       |
| V <sub>OUT</sub>                        | Output Voltage Range                           | ISL91110IIAZ, I <sub>OUT</sub> = 100mA, V <sub>IN</sub> = 3.6V                            | <b>1.00</b>     |                 | <b>5.20</b>     | V     |
|   | Output Voltage Accuracy                        | V <sub>IN</sub> = 3.7V, V <sub>OUT</sub> = 3.3V, I <sub>OUT</sub> = 0mA, PWM mode         | <b>-2</b>       |                 | <b>+2</b>       | %     |
|   |  | V <sub>IN</sub> = 3.7V, V <sub>OUT</sub> = 3.3V, I <sub>OUT</sub> = 1mA, PFM mode         | <b>-3</b>       |                 | <b>+4</b>       | %     |
| V <sub>FB</sub>                         | FB Pin Voltage Regulation                      | For adjustable output version, V <sub>IN</sub> = 3.6V                                     | <b>0.783</b>    | 0.800           | <b>0.813</b>    | V     |
| I <sub>FB</sub>                         | FB Pin Bias Current                            | For adjustable output version   |                 |                 | <b>20</b>       | nA    |
| $\frac{\Delta V_{OUT}}{\Delta V_{IN}}$  | Line Regulation, PWM Mode                      | I <sub>OUT</sub> = 500mA, V <sub>OUT</sub> = 3.3V, V <sub>IN</sub> step from 2.3V to 5.5V |                 | ±5              |                 | mV/V  |
| $\frac{\Delta V_{OUT}}{\Delta I_{OUT}}$ | Load Regulation, PWM Mode                      | V <sub>IN</sub> = 3.7V, V <sub>OUT</sub> = 3.3V, I <sub>OUT</sub> step from 0mA to 1000mA |                 | ±0.005          |                 | mV/mA |
| $\frac{\Delta V_{OUT}}{\Delta V_I}$     | Line Regulation, PFM Mode                      | I <sub>OUT</sub> = 100mA, V <sub>OUT</sub> = 3.3V, V <sub>IN</sub> step from 2.3V to 5.5V |                 | ±12.5           |                 | mV/V  |
| $\frac{\Delta V_{OUT}}{\Delta I_{OUT}}$ | Load Regulation, PFM Mode                      | V <sub>IN</sub> = 3.7V, V <sub>OUT</sub> = 3.3V, I <sub>OUT</sub> step from 0mA to 100mA  |                 | ±0.4            |                 | mV/mA |
| V <sub>CLAMP</sub>                      | Output Voltage Clamp                           | Rising  | <b>5.25</b>     |                 | <b>5.95</b>     | V     |
|   | Output Voltage Clamp Hysteresis                |   |                 | 400             |                 | mV    |
| <b>DC/DC SWITCHING SPECIFICATIONS</b>   |  |   |                 |                 |                 |       |
| f <sub>SW</sub>                         | Oscillator Frequency                           |   | <b>2.10</b>     | 2.50            | <b>2.90</b>     | MHz   |
| t <sub>ONMIN</sub>                      | Minimum On Time                                |   |                 | 80              |                 | ns    |
| I <sub>PFETLEAK</sub>                   | LX1 Pin Leakage Current                        | V <sub>IN</sub> = 3.6V  | <b>-1</b>       |                 | <b>1</b>        | µA    |
| I <sub>NFETLEAK</sub>                   | LX2 Pin Leakage Current                        | V <sub>IN</sub> = 3.6V  | <b>-1</b>       |                 | <b>1</b>        | µA    |

# ISL91110

**Analog Specifications**  $V_{IN} = V_{PVIN} = V_{EN} = 3.6V$ ,  $V_{OUT} = 3.3V$ ,  $L1 = 1\mu H$ ,  $C1 = 2 \times 10\mu F$ ,  $C2 = 2 \times 22\mu F$ ,  $T_A = +25^\circ C$ . **Boldface limits apply across the operating temperature range,  $-40^\circ C$  to  $+85^\circ C$  and input voltage range (1.8V to 5.5V) unless specified otherwise. (Continued)**

| SYMBOL                               | PARAMETER                                     | TEST CONDITIONS  | MIN<br>(Note 6) | TYP<br>(Note 7) | MAX<br>(Note 6) | UNIT |
|--------------------------------------|---|--|-----------------|-----------------|-----------------|------|
| <b>SOFT-START AND SOFT DISCHARGE</b> |   |  |                 |                 |                 |      |
| t <sub>SS</sub>                      | Soft-Start Time                               | Time from when EN signal asserts to when output voltage ramp starts.   |                 | 1               |                 | ms   |
|                                      |   | Time from when output voltage ramp starts to when output voltage reaches 95% of its nominal value with device operating in buck mode.<br>$V_{IN} = 4V$ , $V_{OUT} = 3.3V$ , $I_O = 200mA$  |                 | 1               |                 | ms   |
|                                      |   | Time from when output voltage ramp starts to when output voltage reaches 95% of its nominal value with device operating in boost mode.<br>$V_{IN} = 2V$ , $V_{OUT} = 3.3V$ , $I_O = 200mA$ |                 | 2               |                 | ms   |
| R <sub>DISCHG</sub>                  | V <sub>OUT</sub> Soft-Discharge ON-Resistance | $EN < V_{IL}$  |                 | 120             |                 | Ω    |
| <b>POWER MOSFET</b>                  |   |  |                 |                 |                 |      |
| R <sub>DSON_P</sub>                  | P-Channel MOSFET ON-Resistance                | $V_{IN} = 3.6V$ , $I_O = 200mA$  |                 | 40              |                 | mΩ   |
|                                      |   | $V_{IN} = 2.5V$ , $I_O = 200mA$  |                 | 55              |                 | mΩ   |
| R <sub>DSON_N</sub>                  | N-Channel MOSFET ON-Resistance                | $V_{IN} = 3.6V$ , $I_O = 200mA$  |                 | 30              |                 | mΩ   |
|                                      |   | $V_{IN} = 2.5V$ , $I_O = 200mA$  |                 | 45              |                 | mΩ   |
| I <sub>PK_LMT</sub>                  | P-Channel MOSFET Peak Current Limit           |  | <b>3.9</b>      | 4.5             | <b>5.1</b>      | A    |
| <b>PFM/PWM TRANSITION</b>            |   |  |                 |                 |                 |      |
|                                      | Load Current Threshold, PFM to PWM            | $V_{IN} = 3.6V$ , $V_{OUT} = 3.3V$   |                 | 200             |                 | mA   |
|                                      | Load Current Threshold, PWM to PFM            | $V_{IN} = 3.6V$ , $V_{OUT} = 3.3V$   |                 | 75              |                 | mA   |
|                                      | Thermal Shutdown                              |  |                 | 155             |                 | °C   |
|                                      | Thermal Shutdown Hysteresis                   |  |                 | 30              |                 | °C   |
| <b>LOGIC INPUTS</b>                  |   |  |                 |                 |                 |      |
| I <sub>LEAK</sub>                    | Input Leakage                                 | $V_{IN} = 3.6V$  |                 | 0.05            | <b>1.00</b>     | μA   |
| V <sub>IH</sub>                      | Input HIGH Voltage                            | $V_{IN} = 3.6V$  | <b>1.4</b>      |                 |                 | V    |
| V <sub>IL</sub>                      | Input LOW Voltage                             | $V_{IN} = 3.6V$  |                 |                 | <b>0.4</b>      | V    |

**NOTES:**

- Parameters with MIN and/or MAX limits are 100% tested at +25°C, unless otherwise specified. Temperature limits established by characterization and are not production tested.
- Typical values are for  $T_A = +25^\circ C$  and  $V_{IN} = 3.6V$ .
- Quiescent current measurements are taken when the output is not switching.

## Typical Performance Curves

Unless otherwise noted, operating conditions are:  $T_A = +25^\circ\text{C}$ ,  $V_{IN} = EN = 3.6\text{V}$ ,  $L = 1\mu\text{H}$ ,  $C_1 = 2 \times 10\mu\text{F}$ ,  $C_2 = 2 \times 22\mu\text{F}$ ,  $V_{OUT} = 3.3\text{V}$ ,  $I_{OUT} = 0\text{A to } 3\text{A}$

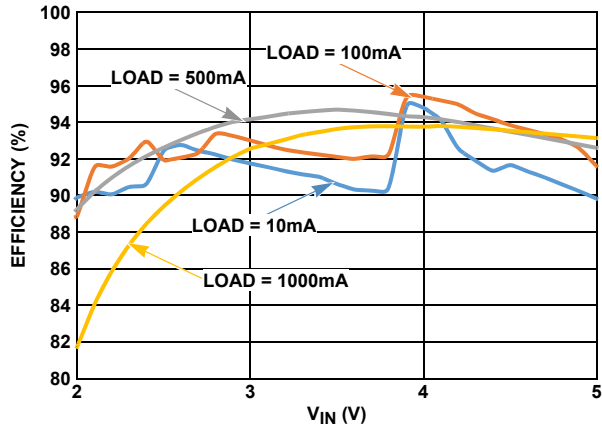

FIGURE 4. EFFICIENCY vs INPUT VOLTAGE

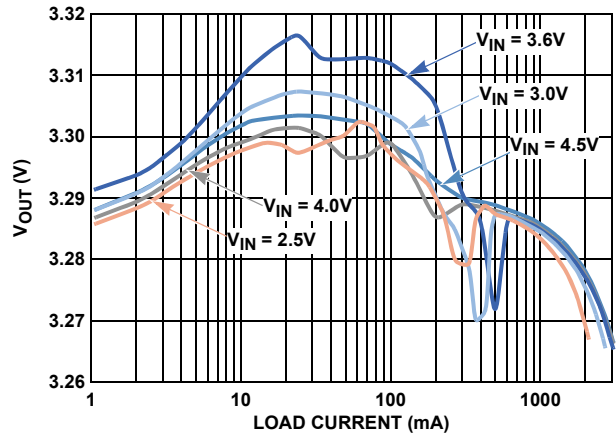

FIGURE 5. OUTPUT VOLTAGE vs LOAD CURRENT

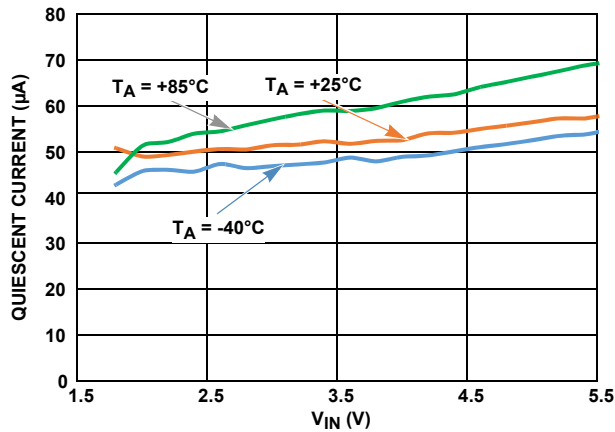

FIGURE 6. QUIESCENT CURRENT vs INPUT VOLTAGE ( $V_{OUT} = 3.3\text{V}$ , MODE = HIGH)

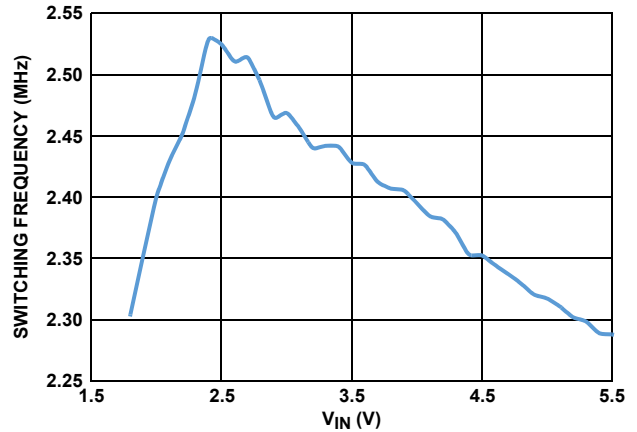

FIGURE 7. SWITCHING FREQUENCY vs INPUT VOLTAGE

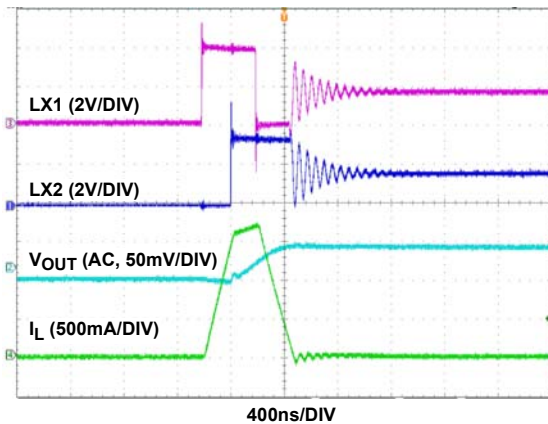

FIGURE 8. STEADY-STATE OPERATION IN PFM ( $V_{IN} = 4\text{V}$ ,  $V_{OUT} = 3.3\text{V}$ , NO LOAD)

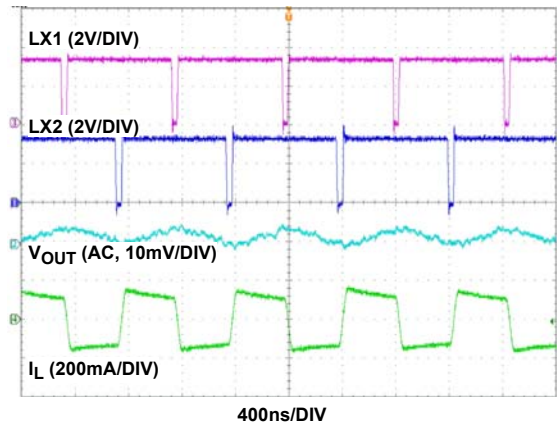

FIGURE 9. STEADY-STATE OPERATION IN PWM ( $V_{IN} = 3.3\text{V}$ ,  $V_{OUT} = 3.3\text{V}$ , NO LOAD)

## Typical Performance Curves

Unless otherwise noted, operating conditions are:  $T_A = +25^\circ\text{C}$ ,  $V_{IN} = EN = 3.6\text{V}$ ,  $L = 1\mu\text{H}$ ,  $C_1 = 2 \times 10\mu\text{F}$ ,  $C_2 = 2 \times 22\mu\text{F}$ ,  $V_{OUT} = 3.3\text{V}$ ,  $I_{OUT} = 0\text{A}$  to  $3\text{A}$  (Continued)

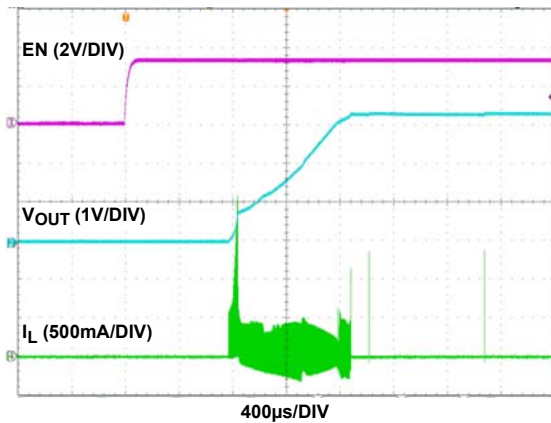

FIGURE 10. SOFT-START ( $V_{IN} = 3.6\text{V}$ ,  $V_{OUT} = 3.3\text{V}$ , NO LOAD)

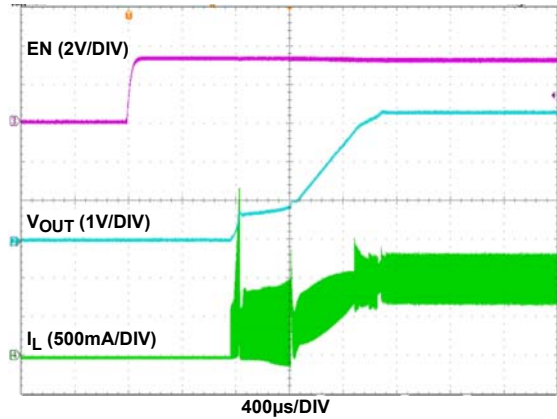

FIGURE 11. SOFT-START ( $V_{IN} = 3.6\text{V}$ ,  $V_{OUT} = 3.3\text{V}$ , 1A R-LOAD)

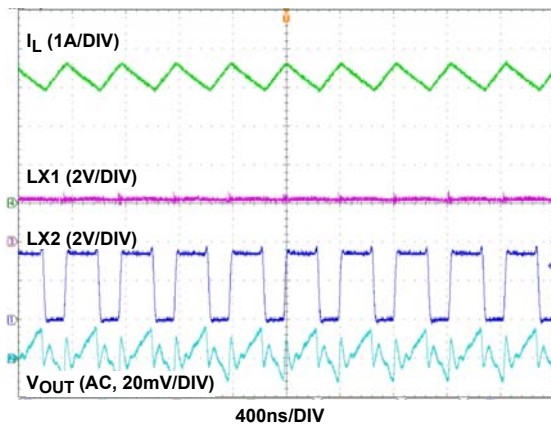

FIGURE 12. STEADY STATE OPERATION ( $V_{IN} = 2.5\text{V}$ ,  $V_{OUT} = 3.3\text{V}$ , 2A LOAD)

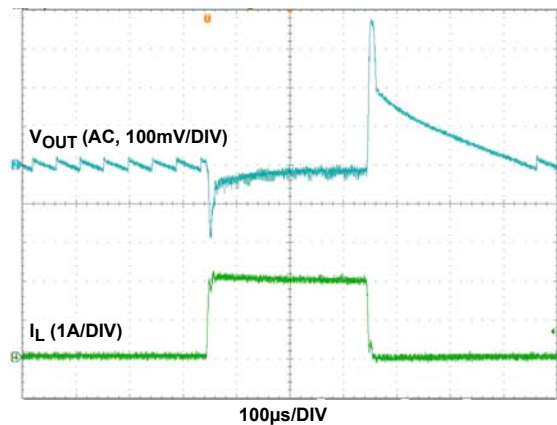

FIGURE 13. 0A TO 2A LOAD TRANSIENT ( $V_{IN} = 3.6\text{V}$ ,  $V_{OUT} = 3.3\text{V}$ )

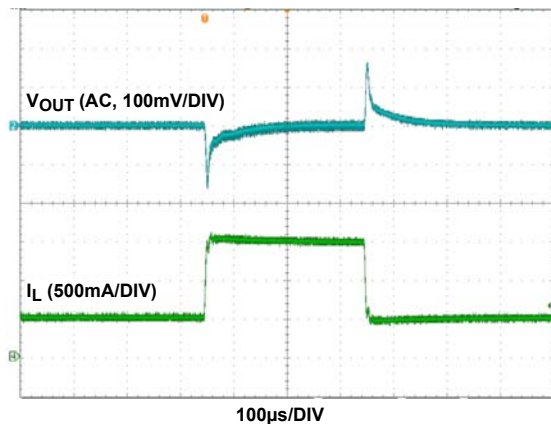

FIGURE 14. 0.5A TO 1.5A LOAD TRANSIENT ( $V_{IN} = 3.6\text{V}$ ,  $V_{OUT} = 3.3\text{V}$ )

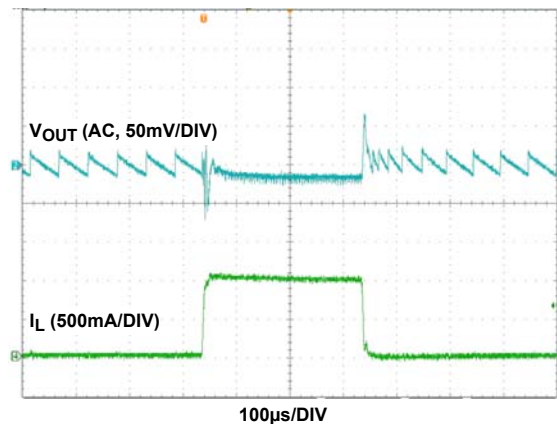

FIGURE 15. 0A TO 1A LOAD TRANSIENT ( $V_{IN} = 3.6\text{V}$ ,  $V_{OUT} = 3.3\text{V}$ )

## Typical Performance Curves

Unless otherwise noted, operating conditions are:  $T_A = +25^\circ\text{C}$ ,  $V_{IN} = EN = 3.6\text{V}$ ,  $L = 1\mu\text{H}$ ,  $C_1 = 2 \times 10\mu\text{F}$ ,  $C_2 = 2 \times 22\mu\text{F}$ ,  $V_{OUT} = 3.3\text{V}$ ,  $I_{OUT} = 0\text{A}$  to  $3\text{A}$  (Continued)

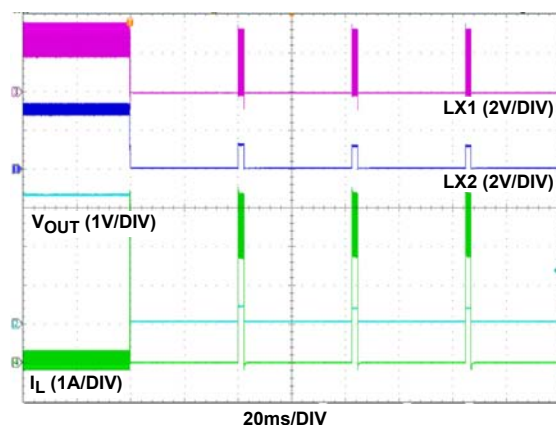

FIGURE 16. OUTPUT SHORT-CIRCUIT BEHAVIOR ( $V_{IN} = 3.6\text{V}$ ,  $V_{OUT} = 3.3\text{V}$ )

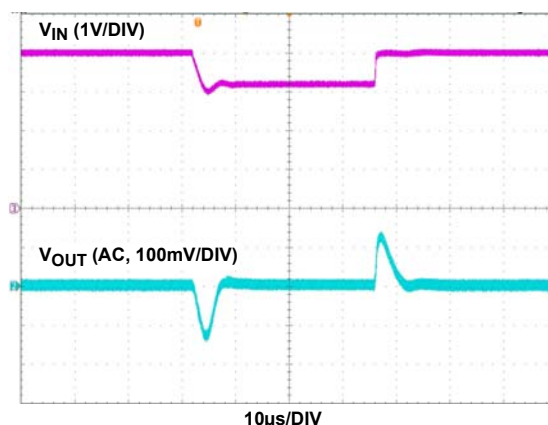

FIGURE 17. 4V TO 3.2V LINE TRANSIENT ( $V_{OUT} = 3.3\text{V}$ , LOAD = 1A)

## Functional Description

### Functional Overview

Refer to the “[Block Diagram](#)” on page 2. The ISL91110 implements a complete buck-boost switching regulator, with PWM controller, internal switches, references, protection circuitry and control inputs.

The PWM controller automatically switches between buck and boost modes as necessary to maintain a steady output voltage, with changing input voltages and dynamic external loads.

### Internal Supply and References

Referring to the “[Block Diagram](#)” on page 2, the ISL91110 provides four power input pins. The PVIN pin supplies input power to the DC/DC converter, while the VIN pin provides operating voltage source required for stable  $V_{REF}$  generation. Separate ground pins (GND and PGND) are provided to avoid problems caused by ground shift due to the high switching currents.

### Enable Input

The device is enabled by asserting the EN pin HIGH. Driving EN LOW invokes a power-down mode, where most internal device functions are disabled.

### Soft Discharge

When the device is disabled by driving EN LOW, an internal resistor between VOUT and GND is activated to slowly discharge the output capacitor. This internal resistor has a typical  $120\Omega$  resistance.

### POR Sequence and Soft-Start

Asserting the EN pin HIGH allows the device to power up. A number of events occur during the start-up sequence. The internal voltage reference powers up, and stabilizes. The device then starts operating. There is a typical 1ms delay between assertion of the EN pin and the start of switching regulator soft-start ramp.

The soft-start feature minimizes output voltage overshoot and input inrush currents. During soft-start, the reference voltage is ramped to provide a ramping  $V_{OUT}$  voltage. While the output voltage is lower than approximately 20% of the target output voltage, switching frequency is reduced to a fraction of the normal switching frequency to aid in producing low duty cycles necessary to avoid input inrush current spikes. Once the output voltage exceeds 20% of the target voltage, switching frequency is increased to its nominal value.

When the target output voltage is higher than the input voltage, there will be a transition from buck mode to boost mode during the soft-start sequence. At the time of this transition, the ramp rate of the reference voltage is decreased, such that the output voltage slew rate is decreased. This provides a slower output voltage slew rate.

The  $V_{OUT}$  ramp time is not constant for all operating conditions. Soft-start into boost mode will take longer than soft-start into buck mode. The total soft-start time into buck operating mode is typically 2ms, whereas the typical soft-start time into boost mode operating mode is typically 3ms. Increasing the load current will increase these typical soft-start times.

### Overcurrent Protection

The ISL91110 provides short-circuit protection by monitoring the feedback voltage. When feedback voltage is sensed to be lower than a certain threshold, the PWM oscillator frequency is reduced in order to protect the device from damage. The P-Channel MOSFET peak current limit remains active during this state.

When the current in the P-Channel MOSFET is sensed to reach the current limit for 16 consecutive switching cycles, the internal protection circuit is triggered, and switching is stopped for approximately 40ms. The device then performs a soft-start cycle. If the external output overcurrent condition exists after the soft-start cycle, the device will again detect 16 consecutive switching cycles reaching the peak current threshold and turns off for 40ms. The process will repeat as long as the external overcurrent condition is present. This behavior is called “hiccup mode”.



## Thermal Shutdown

A built-in thermal protection feature protects the ISL91110 if the die temperature reaches +155 °C (typical). At this die temperature, the regulator is completely shut down. The die temperature continues to be monitored in this thermal shutdown mode. When the die temperature falls to +125 °C (typical), the device will resume normal operation. When exiting thermal shutdown, the ISL91110 will execute its soft-start sequence.

## Buck-Boost Conversion Topology

The ISL91110 operates in either buck or boost mode. When operating in conditions where  $P_{VIN}$  is close to  $V_{OUT}$ , ISL91110 alternates between buck and boost mode as necessary to provide a regulated output voltage.

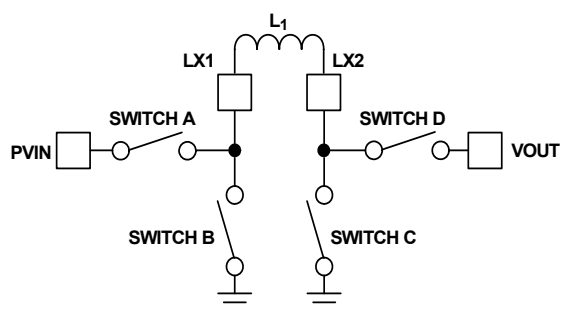

FIGURE 18. BUCK BOOST TOPOLOGY

Figure 18 shows a simplified diagram of the internal switches and external inductor.

## PWM Operation

In buck PWM mode, Switch D is continuously closed, and Switch C is continuously open. Switches A and B operate as a synchronous buck converter when in this mode.

In boost PWM mode, Switch A remains closed and Switch B remains open. Switches C and D operate as a synchronous boost converter when in this mode.

## PFM Operation

During PFM operation in buck mode, Switch D is continuously closed and Switch C is continuously open. Switches A and B operate in discontinuous mode during PFM operation. During PFM operation in boost mode, the ISL91110 closes Switch A and Switch C to ramp up the current in the inductor. When the inductor current reaches a certain threshold, the device turns off Switches A and C, then turns on Switches B and D. With Switches B and D closed, output voltage increases as the inductor current ramps down.

In most operating conditions, there will be multiple PFM pulses to charge up the output capacitor. These pulses continue until  $V_{OUT}$  has achieved the upper threshold of the PFM hysteretic controller. Switching then stops, and remains stopped until  $V_{OUT}$  decays to the lower threshold of the hysteretic PFM controller.

## Operation With $V_{IN}$ Close to $V_{OUT}$

When the output voltage is close to the input voltage, the ISL91110 will rapidly and smoothly switch from boost to buck

mode as needed to maintain the regulated output voltage. This behavior provides excellent efficiency and very low output voltage ripple.

## Output Voltage Programming

The ISL91110 is available in fixed and adjustable output voltage versions. To use the fixed output version, the  $V_{OUT}$  pin must be connected directly to FB.

In the adjustable output voltage version (ISL91110IIAZ), an external resistor divider is required to program the output voltage. The FB pin has very low input leakage current, so it is possible to use large value resistors (e.g.,  $R_1 = 1\text{M}\Omega$  and  $R_2 = 324\text{k}\Omega$  for  $V_{OUT} = 3.3\text{V}$ ) in the resistor divider connected to the FB input.

## Applications Information

### Component Selection

The fixed-output version of ISL91110 requires only three external power components to implement the buck boost converter: an inductor, an input capacitor and an output capacitor.

The adjustable output version of ISL91110 requires three additional components to program the output voltage, as shown in Figure 19. Two external resistors program the output voltage, and a small capacitor is added to improve stability and response.

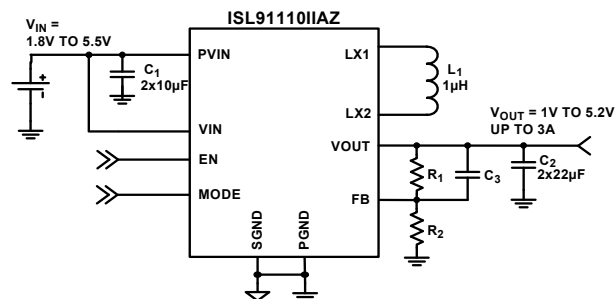

FIGURE 19. ADJUSTABLE OUTPUT APPLICATION

## Output Voltage Programming, Adjustable Version

When  $V_{REF}$  is connected to GND, setting and controlling the output voltage of the ISL91110IIAZ (adjustable output version) can be accomplished by selecting the external resistor values.

Equation 1 can be used to derive the  $R_1$  and  $R_2$  resistor values:

$$V_{OUT} = 0.8\text{V} \cdot \left(1 + \frac{R_1}{R_2}\right) \quad (\text{EQ. 1})$$

When designing a PCB, include a GND guard band around the feedback resistor network to reduce noise and improve accuracy and stability. Resistors  $R_1$  and  $R_2$  should be positioned close to the FB pin.

## Feed-Forward Capacitor Selection

A small capacitor ( $C_3$  in Figure 19) in parallel with resistor  $R_1$  is required to provide the specified load and line regulation. The suggested value of this capacitor is 56pF for  $R_1 = 1\text{M}\Omega$ . An NPO type capacitor is recommended.

## Inductor Selection

TABLE 2. INDUCTOR VENDOR INFORMATION

| MANUFACTURER | MFR. PART NUMBER | DESCRIPTION   | DIMENSION (mm) | WEBSITE  |
|--------------|------------------|---|----------------|--|
| Toko         | 1277AS-H-1R0M    | 1 $\mu$ H, 20%, DCR = 34m $\Omega$ (typ), Isat = 4.6A (typ) | 3.2x2.5x1.2    | <a href="http://www.toko.com">www.toko.com</a>           |
|              | FSD0312-H-1R0M   | 1 $\mu$ H, 20%, DCR = 43m $\Omega$ (typ), Isat = 4.5A (typ) | 3.2x3.0x1.2    |  |
| Coilcraft    | XFL4020-102ME    | 1 $\mu$ H, 20%, DCR = 11m $\Omega$ (typ), Isat = 5.1A (typ) | 4.0x4.0x2.1    | <a href="http://www.coilcraft.com">www.coilcraft.com</a> |

An inductor with high frequency core material (e.g., ferrite core) should be used to minimize core losses and provide good efficiency. The inductor must be able to handle the peak switching currents without saturating.

A 1 $\mu$ H inductor with  $\geq 4A$  saturation current rating is recommended. Select an inductor with low DCR to provide good efficiency. In applications where radiated noise must be minimized, a toroidal or shielded inductor can be used.

## PVIN and VOUT Capacitor Selection

The input and output capacitors should be ceramic X5R type with low ESL and ESR. The recommended input capacitor value is 2x10 $\mu$ F. The recommended V<sub>OUT</sub> capacitor value is 2x22 $\mu$ F.

TABLE 3. CAPACITOR VENDOR INFORMATION

| MANUFACTURER | SERIES | WEBSITE  |
|--------------|--------|--|
| AVX          | X5R    | <a href="http://www.avx.com">www.avx.com</a>         |
| Murata       | X5R    | <a href="http://www.murata.com">www.murata.com</a>   |
| Taiyo Yuden  | X5R    | <a href="http://www.t-yuden.com">www.t-yuden.com</a> |
| TDK          | X5R    | <a href="http://www.tdk.com">www.tdk.com</a>         |

## Recommended PCB Layout

Correct PCB layout is critical for proper operation of the ISL91110. The input and output capacitors should be positioned as closely to the IC as possible. The ground connections of the input and output capacitors should be kept as short as possible, and should be on the component layer to avoid problems that are caused by high switching currents flowing through PCB vias.

# ISL91110

## Revision History

The revision history provided is for informational purposes only and is believed to be accurate, but not warranted. Please go to web to make sure you have the latest revision.

| DATE              | REVISION | CHANGE  |
|-------------------|----------|---|
| February 5, 2016  | FN8434.4 | Added Note to Figure 1 on page 1.<br>Updated pin configuration on page 3 by adding labels.<br>Added Table 1 on page 3.  |
| November 20, 2014 | FN8434.3 | On page 8, "Short Circuit Protection" section title was updated to "Overcurrent Protection." Also in the newly titled "Overcurrent Protection" section, a paragraph was added to explain hiccup mode operation.   |
| October 28, 2014  | FN8434.2 | On Page 1, 3rd paragraph, changed output as low as 0.8V, as high as 5.25V to: "changed output as low as 1.0V, as high as 5.2V".<br>The IC label on Figure 19 changed from ISL91110INZ to ISL91110IAZ<br>Tjb changed from 14 to 13 in Thermal information.   |
| August 22, 2014   | FN8434.1 | Updated Figure 1 on page 1, Changed text from "Li-ion Battery 2.5V to 4.35V" to "VIN = 1.8V TO 5.5V" and "MAX. IOUT = 2A (Min)" to "IOUT = UP TO 3A"<br>Replaced Figure 2 on page 1.<br>Added -T7A parts to the "Ordering Information" table on page 3.<br>Changed "IFB" on page 4, max spec from "1µA to 20nA".<br>Changed Section title on page 5 from "EN LOGIC INPUTS" to "LOGIC INPUTS".<br>Added "Typical Performance Curves" on page 6.<br>Changed text on Figure 19 on page 9, from "VOUT=0.8V TO 5.25V, UP TO 3A" to "VOUT = 1V to 5.2V, UP TO 3A"<br>Replaced "Package Outline Drawing" on page 12. |
| December 24, 2013 | FN8434.0 | Initial Release.  |

## About Intersil

Intersil Corporation is a leading provider of innovative power management and precision analog solutions. The company's products address some of the largest markets within the industrial and infrastructure, mobile computing and high-end consumer markets.

For the most updated datasheet, application notes, related documentation and related parts, please see the respective product information page found at [www.intersil.com](http://www.intersil.com).

You may report errors or suggestions for improving this datasheet by visiting [www.intersil.com/ask](http://www.intersil.com/ask).

Reliability reports are also available from our website at [www.intersil.com/support](http://www.intersil.com/support).

For additional products, see [www.intersil.com/en/products.html](http://www.intersil.com/en/products.html)

Intersil products are manufactured, assembled and tested utilizing ISO9001 quality systems as noted in the quality certifications found at [www.intersil.com/en/support/qualandreliability.html](http://www.intersil.com/en/support/qualandreliability.html)

*Intersil products are sold by description only. Intersil Corporation reserves the right to make changes in circuit design, software and/or specifications at any time without notice. Accordingly, the reader is cautioned to verify that data sheets are current before placing orders. Information furnished by Intersil is believed to be accurate and reliable. However, no responsibility is assumed by Intersil or its subsidiaries for its use; nor for any infringements of patents or other rights of third parties which may result from its use. No license is granted by implication or otherwise under any patent or patent rights of Intersil or its subsidiaries.*

For information regarding Intersil Corporation and its products, see [www.intersil.com](http://www.intersil.com)

# ISL91110

## Package Outline Drawing

### W5x5.25E

5X5 ARRAY 25 BALLS WITH 0.40 PITCH WAFER LEVEL CHIP SCALE PACKAGE (With BSC)

Rev 0, 1/14

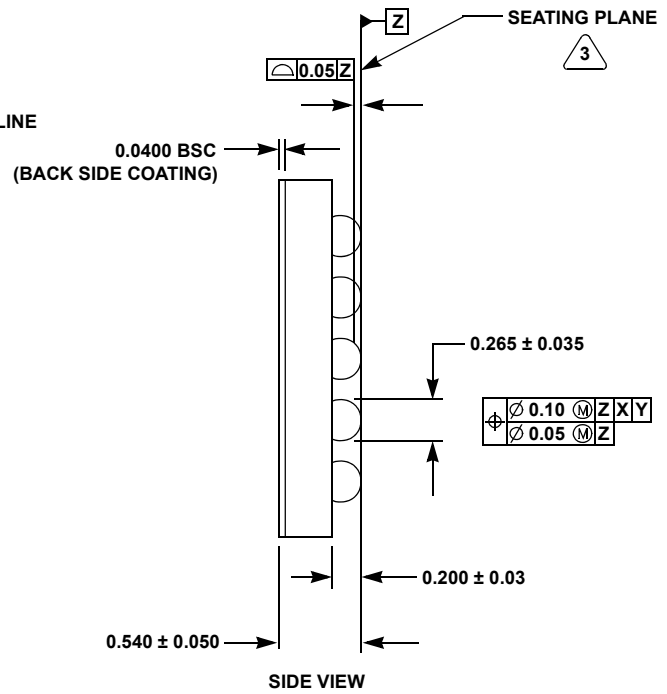
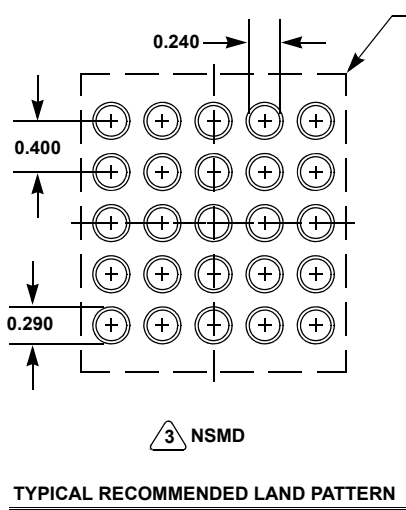
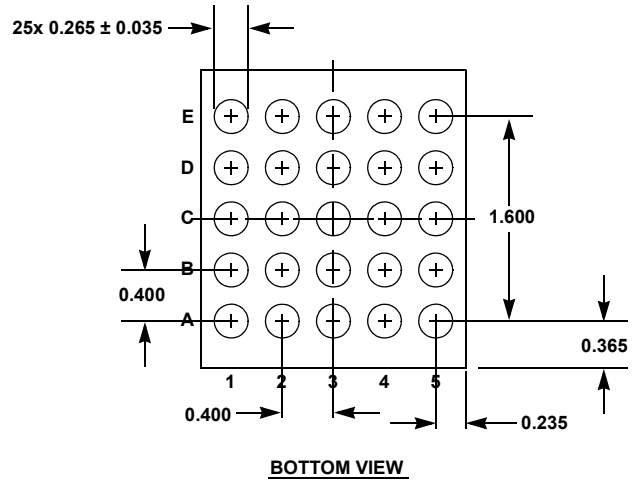
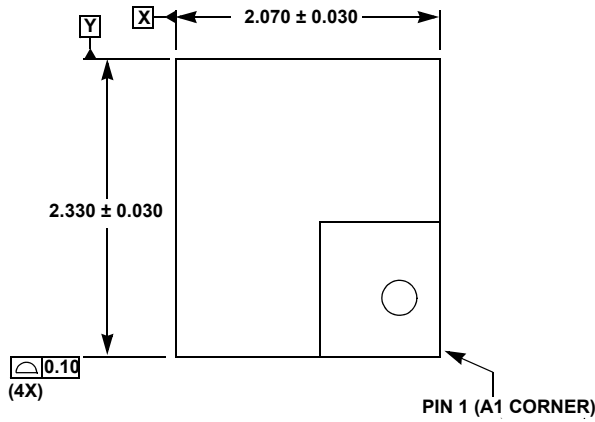

#### NOTES:

- All dimensions are in millimeters.
- Dimension and tolerance per ASMEY 14.5M-1994, and JESD 95-1 SPP-010.
- NSMD refers to Non-Solder Mask Defined pad design per Intersil Tech Brief TB451 located at: <http://www.intersil.com/content/dam/Intersil/documents/tb45/tb451.pdf>