

STD100GKxx B

Thyristor-Diode Modules

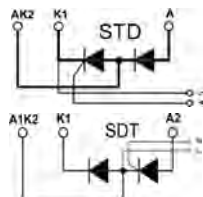

Type	V_{RSM} V_{DSM} V	V_{RRM} V_{DRM} V
STD100GK08B	900	800
STD100GK12B	1300	1200
STD100GK14B	1500	1400
STD100GK16B	1700	1600
STD100GK18B	1900	1800
STD100GK20B	2100	2000
STD100GK22B	2300	2200

Dimensions in mm (1mm=0.0394")

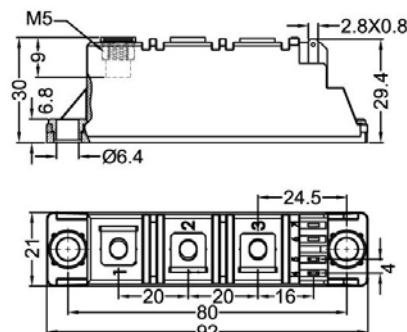

Symbol	Test Conditions	Maximum Ratings	Unit
I_{TRMS}, I_{FRMS} I_{TAVM}, I_{FAVM}	$T_{VJ}=T_{VJM}$ $T_C=85^{\circ}C; 180^{\circ}$ sine	180 100	A
I_{TSM}, I_{FSM}	$T_{VJ}=45^{\circ}C$ $V_R=0$ $t=10ms$ (50Hz), sine $t=8.3ms$ (60Hz), sine	1700 1800	A
	$T_{VJ}=T_{VJM}$ $V_R=0$ $t=10ms$ (50Hz), sine $t=8.3ms$ (60Hz), sine	1540 1640	
$\int i^2 dt$	$T_{VJ}=45^{\circ}C$ $V_R=0$ $t=10ms$ (50Hz), sine $t=8.3ms$ (60Hz), sine	14450 13500	A^2s
	$T_{VJ}=T_{VJM}$ $V_R=0$ $t=10ms$ (50Hz), sine $t=8.3ms$ (60Hz), sine	11850 11300	
$(di/dt)_{cr}$	$T_{VJ}=T_{VJM}$ $f=50Hz, t_p=200us$ $V_D=2/3V_{DRM}$ $I_G=0.45A$ $di_G/dt=0.45A/us$	repetitive, $I_T=250A$ 150	A/us
	non repetitive, $I_T=I_{TAVM}$	500	
$(dv/dt)_{cr}$	$T_{VJ}=T_{VJM};$ $R_{GK}=\infty;$ method 1 (linear voltage rise)	$V_{DR}=2/3V_{DRM}$ 1000	V/us
P_{GM}	$T_{VJ}=T_{VJM}$ $I_T=I_{TAVM}$	$t_p=30us$ 10	W
		$t_p=300us$ 5	
P_{GAV}		0.5	W
V_{RGM}		10	V
T_{VJ} T_{VJM} T_{stg}		-40...+125	$^{\circ}C$
		125	
		-40...+125	
V_{ISOL}	50/60Hz, RMS $I_{ISOL} \leq 1mA$	$t=1min$ 3000	V~
		$t=1s$ 3600	
M_d	Mounting torque (M5) Terminal connection torque (M5)	2.5-4.0/22-35	Nm/lb.in.
		2.5-4.0/22-35	
Weight	Typical	110	g

Sirectifier[®]

STD100GKxx B

Thyristor-Diode Modules

Symbol	Test Conditions	Characteristic Values	Unit
I_{RRM}, I_{DRM}	$T_{VJ}=T_{VJM}; V_R=V_{RRM}; V_D=V_{DRM}$	15	mA
V_T, V_F	$I_T, I_F=300A; T_{VJ}=25^{\circ}C$	1.74	V
V_{TO}	For power-loss calculations only ($T_{VJ}=T_{VJM}$)	0.85	V
r_T		3.2	m Ω
V_{GT}	$V_D=6V; T_{VJ}=25^{\circ}C$ $T_{VJ}=-40^{\circ}C$	1.5 1.6	V
I_{GT}	$V_D=6V; T_{VJ}=25^{\circ}C$ $T_{VJ}=-40^{\circ}C$	100 200	mA
V_{GD}	$T_{VJ}=T_{VJM}; V_D=2/3V_{DRM}$	0.25	V
I_{GD}	$T_{VJ}=T_{VJM}; V_D=2/3V_{DRM}$	10	mA
I_L	$T_{VJ}=25^{\circ}C; t_p=30\mu s; V_D=6V$ $I_G=0.45A; di_G/dt=0.45A/\mu s$	200	mA
I_H	$T_{VJ}=25^{\circ}C; V_D=6V; R_{GK}=\infty$	150	mA
t_{gd}	$T_{VJ}=25^{\circ}C; V_D=1/2V_{DRM}$ $I_G=0.45A; di_G/dt=0.45A/\mu s$	2	μs
t_q	$T_{VJ}=T_{VJM}; I_T=150A; t_p=200\mu s; -di/dt=10A/\mu s$ $V_R=100V; dv/dt=20V/\mu s; V_D=2/3V_{DRM}$	185	μs
Q_S	$T_{VJ}=T_{VJM}; I_T, I_F=50A; -di/dt=6A/\mu s$	170	μC
I_{RM}		45	A
R_{thJC}	per thyristor/diode; DC current per module	0.22 0.11	K/W
R_{thJK}	per thyristor/diode; DC current per module	0.42 0.21	K/W
d_s	Creeping distance on surface	12.7	mm
d_A	Creepage distance in air	9.6	mm
a	Maximum allowable acceleration	50	m/s ²

FEATURES

- * International standard package
- * Copper base plate
- * Glass passivated chips
- * Isolation voltage 3600 V~
- * UL file NO.E310749
- * RoHS compliant

APPLICATIONS

- * DC motor control
- * Softstart AC motor controller
- * Light, heat and temperature control

ADVANTAGES

- * Space and weight savings
- * Simple mounting with two screws
- * Improved temperature and power cycling
- * Reduced protection circuits



STD100GKxxB

Thyristor-Diode Modules

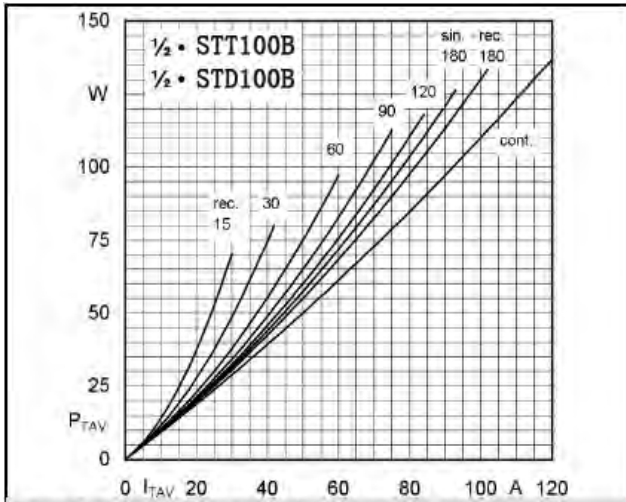

Fig. 1L Power dissipation per thyristor vs. on-state current

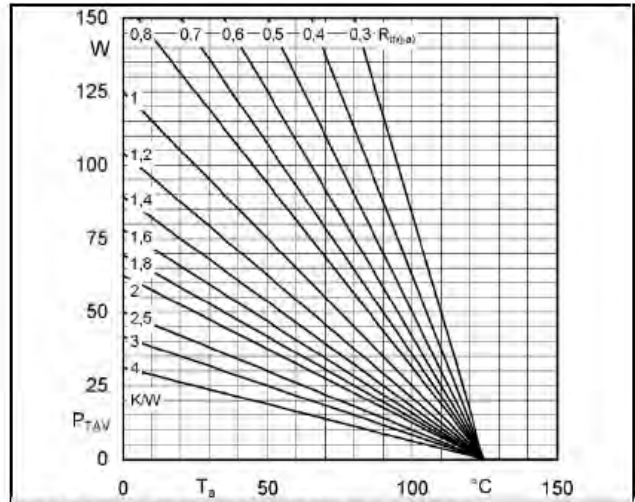

Fig. 1R Power dissipation per thyristor vs. ambient temp.

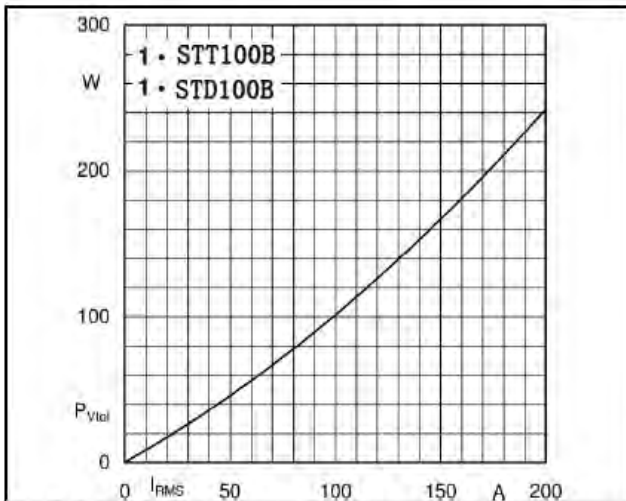

Fig. 2L Power dissipation per module vs. rms current

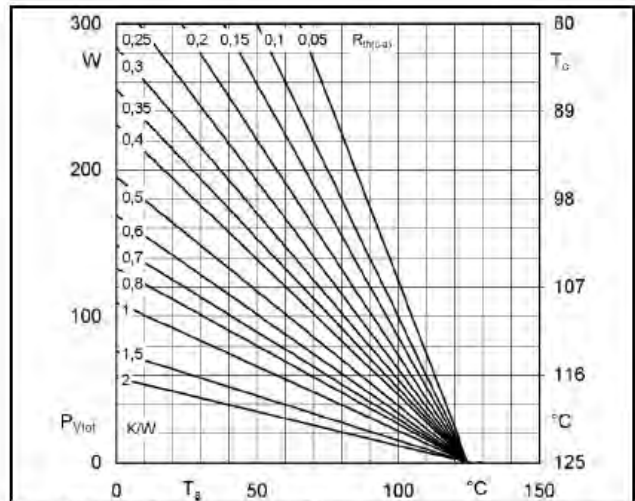

Fig. 2R Power dissipation per module vs. case temp.

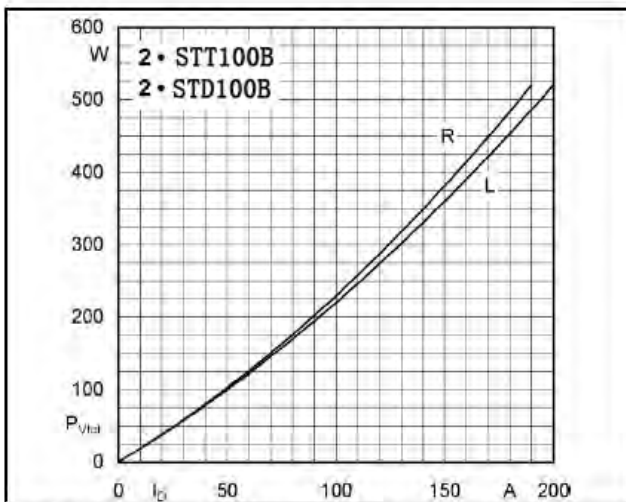

Fig. 3L Power dissipation of two modules vs. direct current

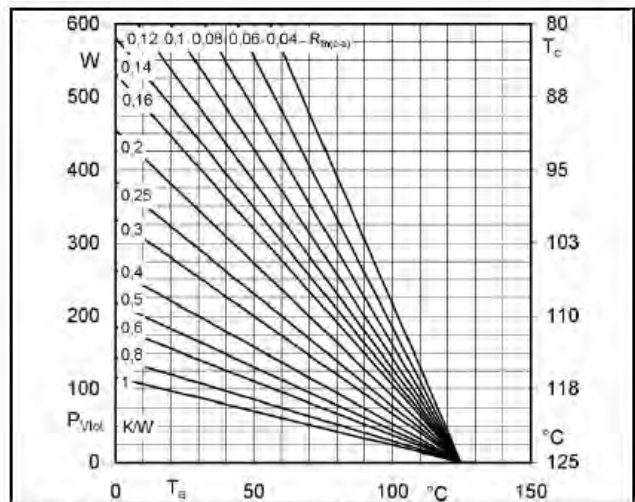

Fig. 3R Power dissipation of two modules vs. case temp.

Sirectifier®

STD100GKxxB

Thyristor-Diode Modules

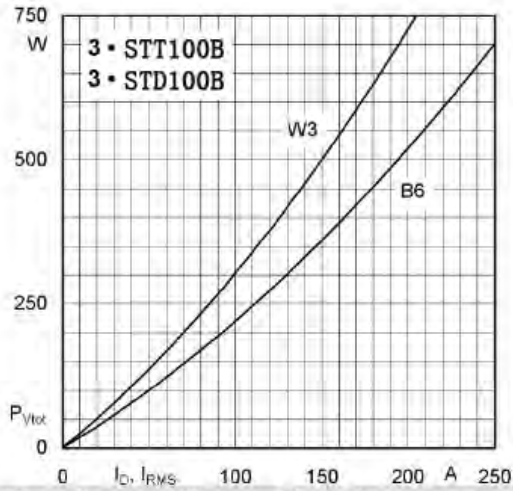

Fig. 4L Power dissipation of three modules vs. direct and rms current

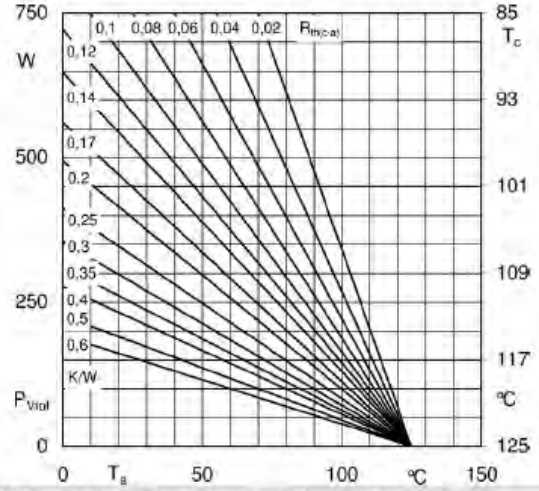

Fig. 4R Power dissipation of three modules vs. case temp.

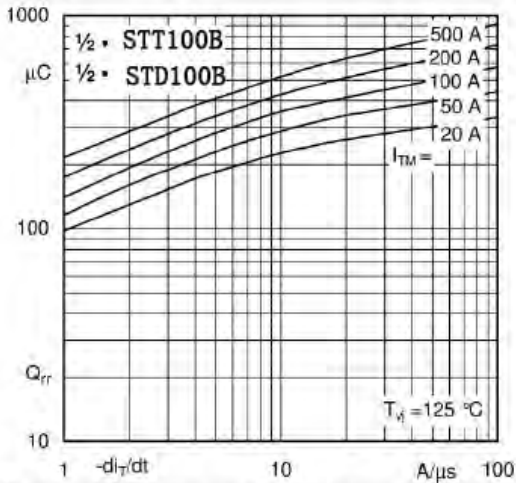

Fig. 5 Recovered charge vs. current decrease

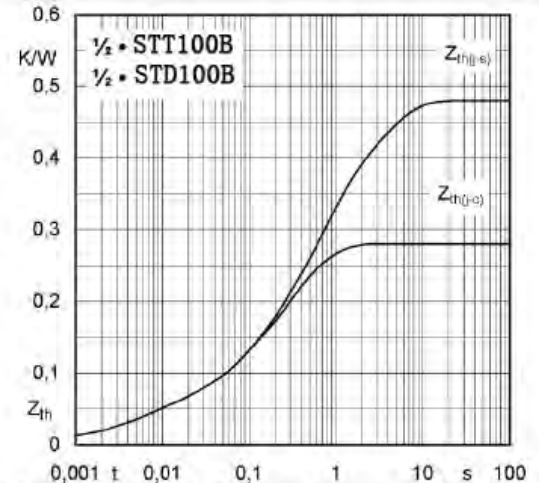

Fig. 6 Transient thermal impedance vs. time

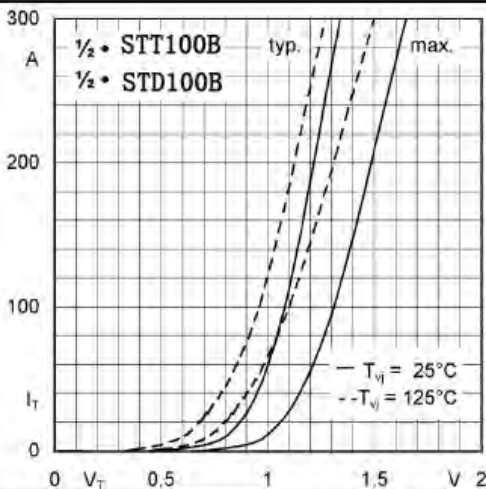

Fig. 7 On-state characteristics

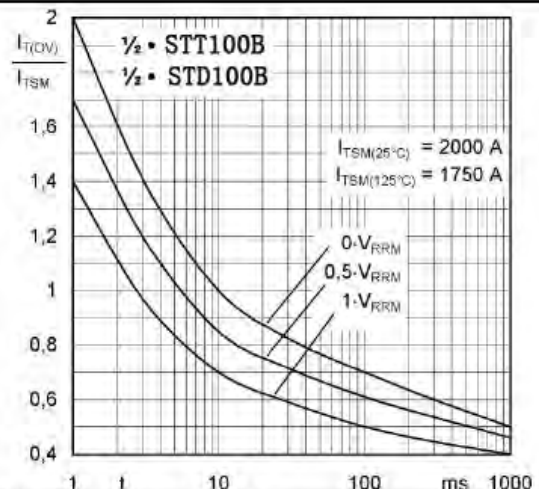

Fig. 8 Surge overload current vs. time