

General Description

The XLH is an HCMOS Crystal Oscillator with 750fs typical phase jitter over 12kHz to 20 MHz bandwidth. Available in a wide frequency range from 0.750MHz to 250MHz, the IDT XLH Series Crystal Oscillator utilizes a family of proprietary ASICs, with a key focus on noise reduction technologies.

The 3rd order Delta Sigma Modulator reduces noise to the levels that are comparable to traditional Bulk Quartz and SAW oscillators. With short lead-time, low cost, low noise, wide frequency range, excellent ambient performance, the XLH is an excellent choice over the conventional technologies. The XLH has stabilities as tight as $\pm 20\text{ppm}$ with extremely quick delivery for both standard and custom frequencies

Features

- Frequency range: 0.750 to 250 MHz
- Output Type: HCMOS/LVCMOS Compatible
- Frequency Stability: $\pm 20\text{ppm}$, $\pm 25\text{ppm}$, $\pm 50\text{ppm}$, or $\pm 100\text{ppm}$
- Supply Voltage: 2.5V or 3.3V
- Phase Jitter (1.875MHz to 20MHz): 225fs typical
- Phase Jitter (12kHz to 20MHz): 750fs typical
- Package options: 3.2mm x 2.5mm x 1.0mm (JX4)
5.0mm x 3.2mm x 1.2mm (JS4)
7.0mm x 5.0mm x 1.3mm (JU4)
- Operating Temperatures: -20°C to $+70^{\circ}\text{C}$ or -40°C to $+85^{\circ}\text{C}$

Pin Assignment

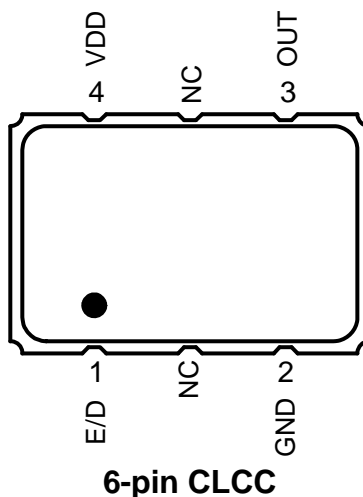

Pin Descriptions

Pin Number	Pin Name	Description
1	E/D	Enable/Disable ¹ (0=Output Disabled)
2	GND	Connect to ground
3	OUT	Output
4	VDD	Supply voltage

1. Pulled high internally.

Absolute Maximum Ratings

Stresses above the ratings listed below can cause permanent damage to the XLH. These ratings, which are standard values for IDT commercially rated parts, are stress ratings only. Functional operation of the device at these or any other conditions above those indicated in the operational sections of the specifications is not implied. Exposure to absolute maximum rating conditions for extended periods can affect product reliability. Electrical parameters are guaranteed only over the recommended operating temperature range.

Item	Rating
VDD	-0.5 to +5.0 V
E/D	-0.5 V to VDD + 0.5 V
OUT	-0.5 V to VDD + 0.5 V
Storage Temperature	-55°C to 125°C
Theta Ja (Junction to Ambient)	102°C/W – Still Air

ESD Compliance

Human Body Model (HBM)	1000V
Machine Model (MM)	150V

Mechanical Testing

Parameter	Test Method
Mechanical Shock	Drop from 75cm to hardwood surface–3 times
Mechanical Vibration	10–55Hz, 1.5mm amplitude, 1 minute sweep 2 hours each in 3 directions (X, Y, Z)
High Temperature Burn-in	Under power @ 125°C for 2000 hours
Hermetic Seal	He pressure: 4 ±1kgf/cm ² 2 hour soak

Solder Reflow Profile

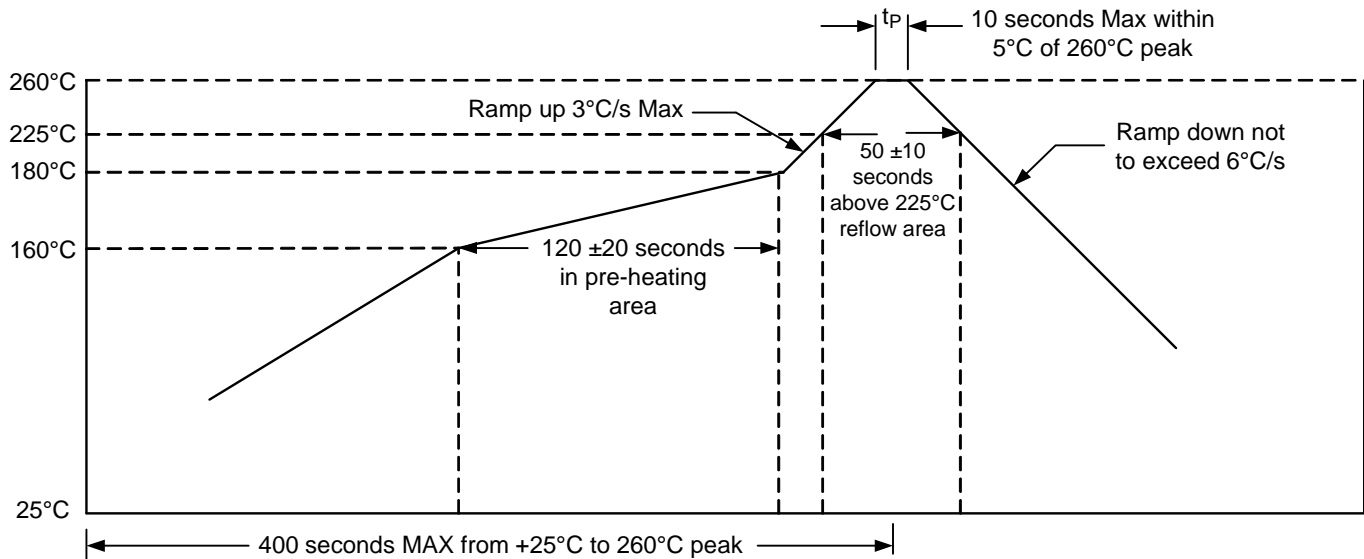

DC Characteristics

($V_{DD} = 3.3\text{ V} \pm 5\%$, $T_A = -20^\circ\text{C}$ to $+70^\circ\text{C}$; -40° to $+85^\circ\text{C}$)

Parameter	Symbol	Condition	Min	Typ	Max	Units
Power Supply Current	I_{DD}	Standard Frequencies			55	mA
Output HIGH Voltage	V_{OH}	$F_{out} = 0.750$ to 150MHz $F_{out} = 150+$ to 250MHz	$90\%V_{DD}$ $80\%V_{DD}$			V
Output LOW Voltage	V_{OL}	$F_{out} = 0.750$ to 150MHz $F_{out} = 150+$ to 250MHz			$10\%V_{DD}$ $20\%V_{DD}$	V
Enable/Disable Input HIGH Voltage (Output enabled)*	V_{IH}		$70\%V_{DD}$			V
Enable/Disable Input LOW Voltage (Output disabled)	V_{IL}				$30\%V_{DD}$	V

* A pullup resistor from pin 4 (VDD) to pin 1 (E/D) enables output when pin 1 is left open.

AC Characteristics

($V_{DD} = 3.3\text{ V} \pm 5\%$, $T_A = -20^\circ\text{C}$ to $+70^\circ\text{C}$; -40° to $+85^\circ\text{C}$)

Parameter	Symbol	Condition	Min	Typ	Max	Units
Output Frequency Range	F_{OUTR}		0.750		250	MHz
Frequency Stability		Temperature = -20°C to $+70^\circ\text{C}$	± 20		± 100	ppm
		Temperature = -40°C to $+85^\circ\text{C}$	± 25		± 100	ppm
Aging (1 st year)		$T_a = 25^\circ\text{C}$			± 3	
Aging (10 years)		$T_a = 25^\circ\text{C}$			± 10	
Output Load					15	pF
Start-up Time	T_{ST}	Output valid time after VDD meets minimum specified level			10	ms
Output Rise Time		20% to 80% V_{DD}			3	ns
Output Fall Time		80% to 20% V_{DD}			3	ns
Duty Cycle	T_{DTCY}	@ 50% V_{DD}	45		55	%
Output Enable/ Disable Time	T_{OE}				100	ns
Period Jitter, RMS	J_{PER}	Frequency = 125MHz		3		psec
Random Jitter	R_J	Frequency = 125MHz Per MJSQ spec (Methodologies for Jitter and Signal Quality specifications)		1.2		psec
Deterministic Jitter	D_J			8		psec
Total Jitter	T_J				25.2	
Phase Jitter (12kHz – 20MHz)	ϕ_{JITTER}	Frequency = 125MHz		0.75		psec
Phase Noise Performance Frequency = 125 MHz	ϕ_{NOISE}	100Hz of Carrier		-95		dBc/Hz
		1kHz of Carrier		-118		dBc/Hz
		10kHz of Carrier		-120		dBc/Hz
		100kHz of Carrier		-124		dBc/Hz
		1MHz of Carrier		-143		dBc/Hz
		10MHz of Carrier		-153		dBc/Hz
Output Frequency (Standards)	F_{OUT}	10MHz, 12MHz, 12.288MHz, 16MHz, 20MHz, 24MHz, 24.576MHz, 25MHz, 33.333MHz, 40MHz, 48MHz, 50MHz, 100MHz, 125MHz, 156.25MHz (Contact IDT for additional frequencies)				

Note: Inclusive of initial frequency accuracy, operating temperature range, supply variation, load variation, 3 times solder reflow, shock, vibration and 1 year aging at 25°C. We do not recommend hand soldering the devices

DC Characteristics

($V_{DD} = 2.5\text{ V} \pm 5\%$, $T_A = -20^\circ\text{C}$ to $+70^\circ\text{C}$; -40° to $+85^\circ\text{C}$)

Parameter	Symbol	Condition	Min	Typ	Max	Units
Power Supply Current	I_{DD}	Standard Frequencies			35	mA
Output HIGH Voltage	V_{OH}	$F_{out} = 0.750$ to 160MHz $F_{out} = 160+$ to 180MHz	$10\%V_{DD}$ $20\%V_{DD}$			V
Output LOW Voltage	V_{OL}	$F_{out} = 0.750$ to 160MHz $F_{out} = 160+$ to 180MHz			$10\%V_{DD}$ $20\%V_{DD}$	V
Enable/Disable Input HIGH Voltage (Output enabled)*	V_{IH}		$70\%V_{DD}$			V
Enable/Disable Input LOW Voltage (Output disabled)	V_{IL}				$30\%V_{DD}$	V

* A pullup resistor from pin 4 (VDD) to pin 1 (E/D) enables output when pin 1 is left open.

AC Characteristics

($V_{DD} = 2.5\text{ V} \pm 5\%$, $T_A = -20^\circ\text{C}$ to $+70^\circ\text{C}$; -40° to $+85^\circ\text{C}$)

Parameter	Symbol	Condition	Min	Typ	Max	Units
Output Frequency Range	F_{OUTR}		0.750		180	MHz
Frequency Stability		Temperature = -20°C to $+70^\circ\text{C}$	± 20		± 100	ppm
		Temperature = -40°C to $+85^\circ\text{C}$	± 25		± 100	ppm
Output Load					15	pF
Start-up Time	T_{ST}	Output valid time after VDD meets minimum specified level			10	ms
Output Rise Time		20% to 80% V_{DD}			3	ns
Output Fall Time		80% to 20% V_{DD}			3	ns
Duty Cycle	T_{DTCY}	@ 50% V_{DD}	45		55	%
Output Enable/ Disable Time	T_{OE}				100	ns
Period Jitter, RMS	J_{PER}	Frequency = 125MHz		3.3		psec
Random Jitter	R_J	Frequency = 125MHz		1.3		psec
Deterministic Jitter	D_J	Per MJSQ spec (Methodologies for Jitter and Signal Quality specifications)		6.7		psec
Total Jitter	T_J			25.6		psec
Phase Jitter (12kHz – 20MHz)	ϕ_{JITTER}	Frequency = 125MHz		0.85		psec
Phase Noise Performance Frequency = 125 MHz	ϕ_{NOISE}	100Hz of Carrier		-91		dBc/Hz
		1kHz of Carrier		-107		dBc/Hz
		10kHz of Carrier		-117		dBc/Hz
		100kHz of Carrier		-123		dBc/Hz
		1MHz of Carrier		-140		dBc/Hz
		10MHz of Carrier		-149		dBc/Hz
Output Frequency (Standards)	F_{OUT}	10MHz, 12MHz, 12.288MHz, 16MHz, 20MHz, 24MHz, 24.576MHz, 25MHz, 33.333MHz, 40MHz, 48MHz, 50MHz, 100MHz, 125MHz, 156.25MHz (Contact IDT for additional frequencies)				

Note: Inclusive of initial frequency accuracy, operating temperature range, supply variation, load variation, 3 times solder reflow, shock, vibration and 1 year aging at 25°C. We do not recommend hand soldering the devices

Output Waveform

Rise Time / Fall Time Measurements

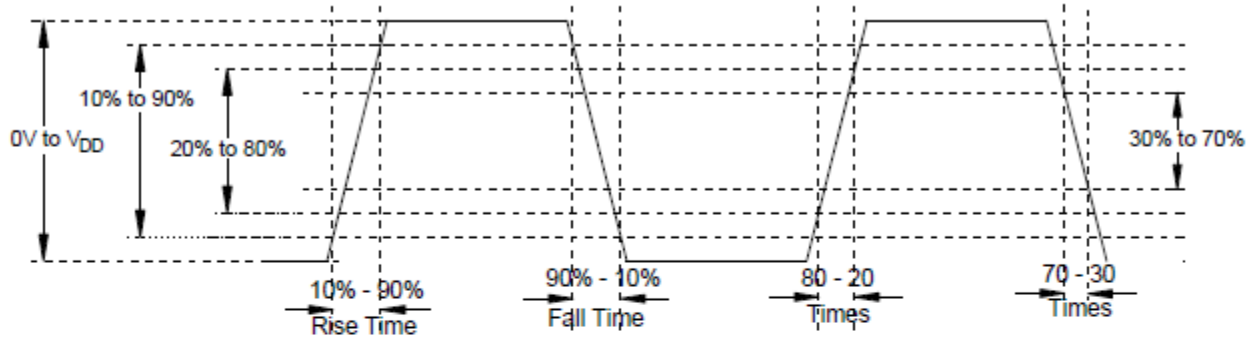

Oscillator Symmetry

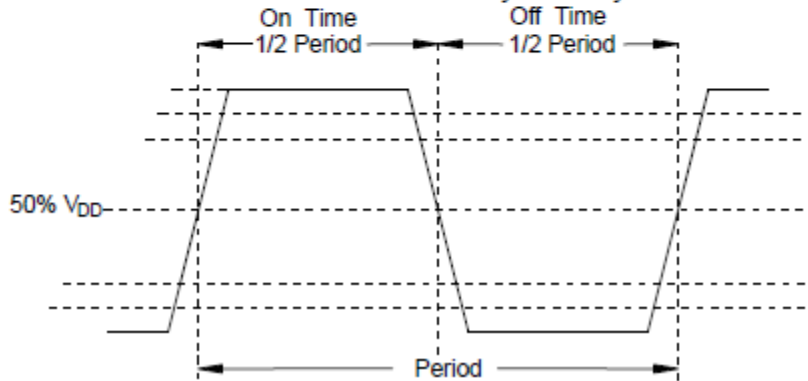

Typical Phase Noise (3.3V)

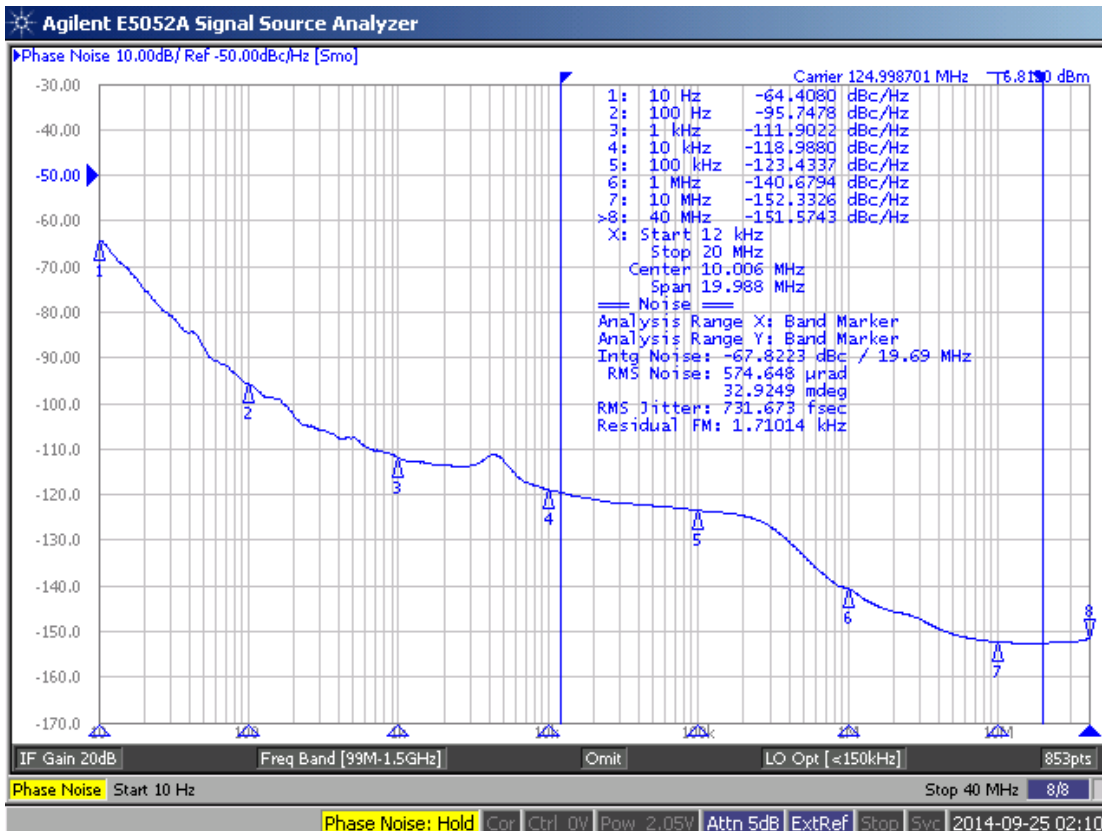

JS4 Package Outline and Dimensions

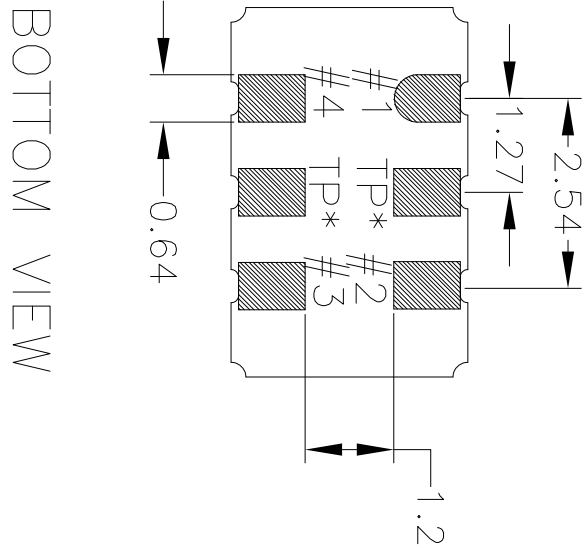
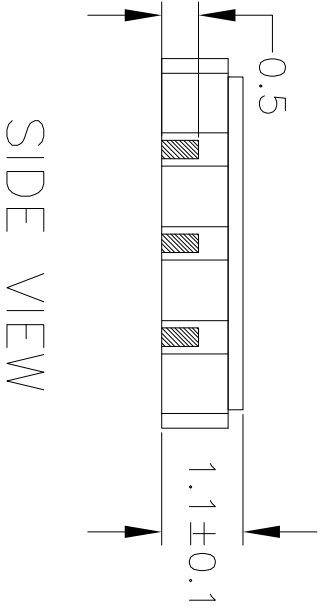
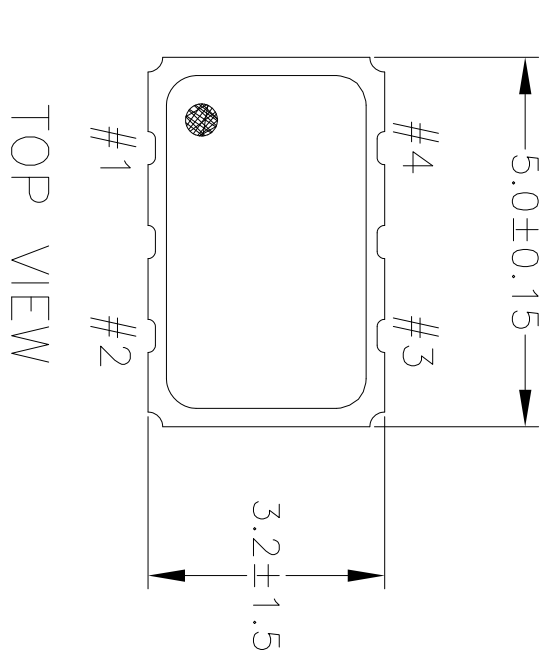

NOTES:
1. ALL DIMENSIONS IN MM.

REV	DESCRIPTION	DATE	APPROVED
00	INITIAL RELEASE	08/21/12	K. Stahn
01	UPDATED LID TOLERANCES	12/03/12	K. Stahn
02	UPDATE PACKAGE DRAWING	8/8/14	JHUA

TOLERANCES UNLESS SPECIFIED	
DECIMAL	ANGULAR
XXX	±
XXXX	
XXXXX	
APPROVALS	DATE
DRAWN JCS	07/16/12
CHECKED	
SIZE	DRAWING No.
C	PSC-4429
REV	02

NO NOT SCALE DRAWING SHEET 1 OF 2

8024 Silver Creek Valley Rd
San Jose, CA 95138
PHONE: (408) 727-6116
FAX: (408) 492-8674
www.IDT.com

JS4 Package Outline and Dimensions (cont.)

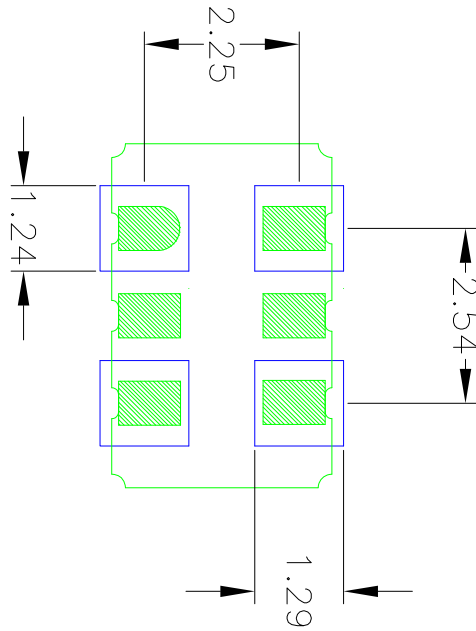

RECOMMENDED LAND PATTERN

- NOTES:
1. ALL DIMENSION ARE IN mm. ANGLES IN DEGREES.
 2. TOP DOWN VIEW, AS VIEWED ON PCB.
 3. COMPONENT OUTLINE SHOW FOR REFERENCE IN GREEN.
 4. LAND PATTERN IN BLUE. NSMD PATTERN ASSUMED.
 5. LAND PATTERN RECOMMENDATION PER IPC-7351B GENERIC REQUIREMENT FOR SURFACE MOUNT DESIGN AND LAND PATTERN.

REVISIONS			
REV	DESCRIPTION	DATE	APPROVED
00	INITIAL RELEASE	08/21/12	K. Sidhn
01	UPDATED LID TOLERANCES	12/03/12	K. Sidhn
02	UPDATE PACKAGE DRAWING	8/8/14	JHUA

TOLERANCES UNLESS SPECIFIED			6024 Silver Creek Valley Rd San Jose, CA 95138 Phone: (408) 727-6116 Fax: (408) 482-8674	
DECIMAL	ANGULAR		www.IDT.com	
XXXX	°	TITLE JS4 PACKAGE OUTLINE 5.0 x 3.2 mm BODY 1.1 mm Thick		
APPROVALS	DATE	SIZE	DRAWING No.	REV
CHECKED	07/18/12	C	PSC-4429	02
DO NOT SCALE DRAWING				SHEET 2 OF 2

JU4 Package Outline and Dimensions

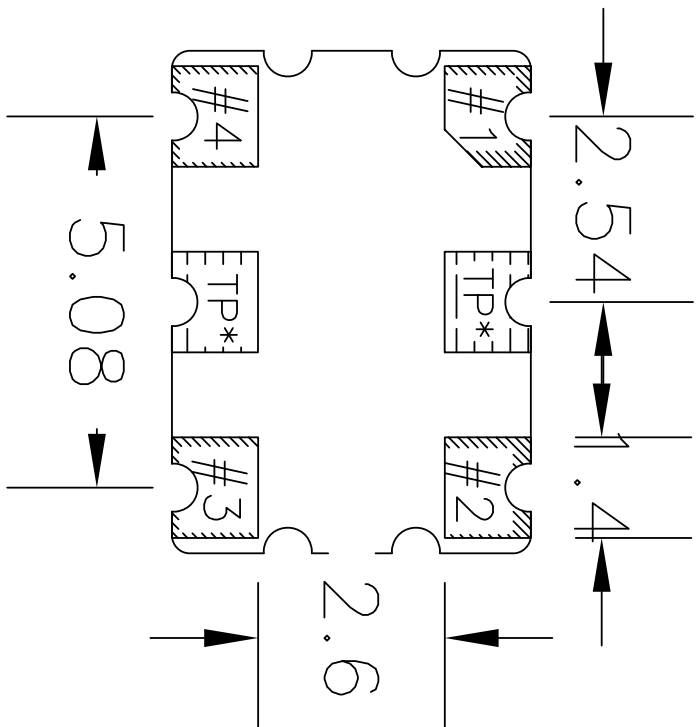
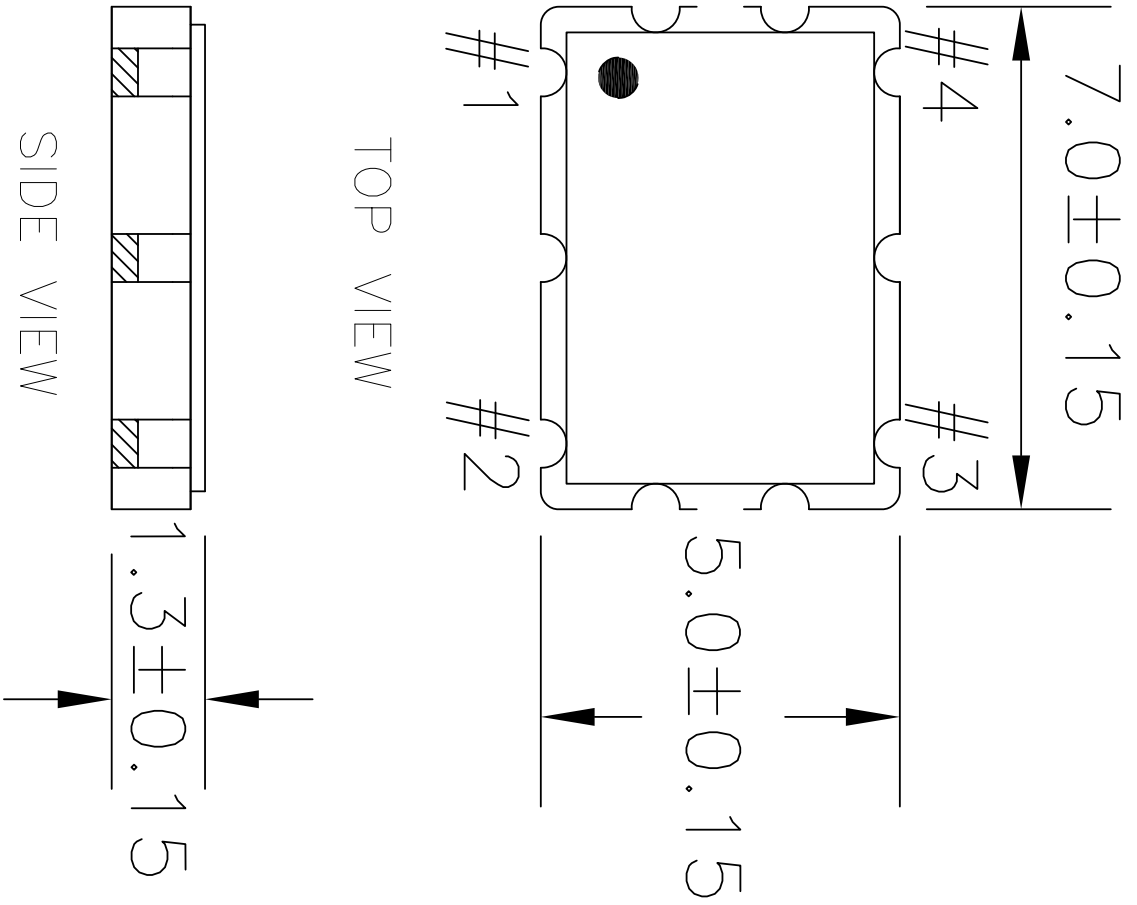

NOTES:
1. ALL DIMENSIONS IN MM.

REVISIONS			
REV	DESCRIPTION	DATE	APPROVED
00	INITIAL RELEASE	10/09/12	KS
01	UPDATE PACKAGE DRWG	8/11/14	JHUA

TOLERANCES UNLESS SPECIFIED		<p>6024 Silver Creek Valley Rd San Jose, CA 95138 PHONE: (408) 727-6116 FAX: (408) 492-8674</p>
DECIMAL	ANGULAR	
XXX ±	±	
XXXX ±		
APPROVALS	DATE	TITLE
DRAWN XJS	10/09/12	JU4 PACKAGE OUTLINE
CHECKED		7.0 x 5.0 mm BODY
		1.3 mm Thick
SIZE	DRAWING No.	REV
C	PSC-4431	01
DO NOT SCALE DRAWING		SHEET 1 OF

JU4 Package Outline and Dimensions (cont.)

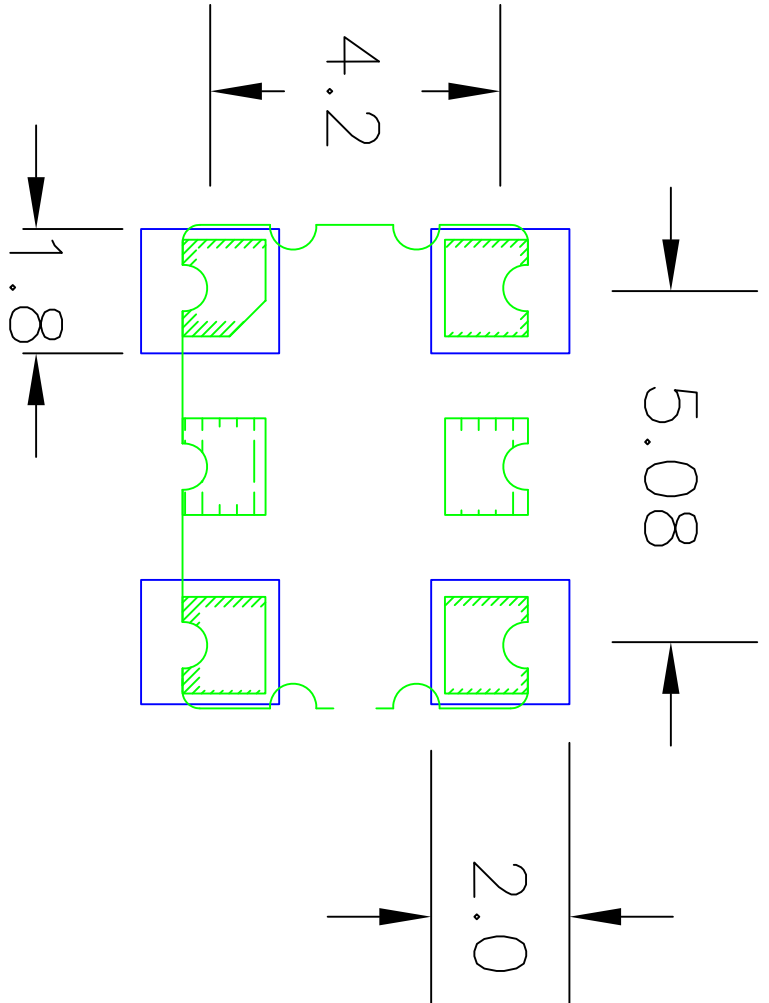

RECOMMENDED LAND PATTERN

NOTES:

1. ALL DIMENSION ARE IN mm. ANGLES IN DEGREES.
2. TOP DOWN VIEW, AS VIEWED ON PCB.
3. COMPONENT OUTLINE SHOW FOR REFERENCE IN GREEN.
4. LAND PATTERN IN BLUE. NSMD PATTERN ASSUMED.
5. LAND PATTERN RECOMMENDATION PER IPC-7351B GENERIC REQUIREMENT FOR SURFACE MOUNT DESIGN AND LAND PATTERN.

REVISIONS			
REV	DESCRIPTION	DATE	APPROVEI
00	INITIAL RELEASE	10/09/12	KS
01	UPDATE PACKAGE DRWING	8/11/14	J.HUA

TOLERANCES UNLESS SPECIFIED			6024 Silver Creek Valley R San Jose, CA 95138 PHONE: (408) 727-6116 FAX: (408) 492-9874
DECIMAL	ANGULAR		
±	±	www.IDT.com	
APPROVALS	DATE	TITLE	
XXXXX	10/09/12	JU4 PACKAGE OUTLINE	
DRAWN	3/3	7.0 x 5.0 mm BODY	
CHECKED		1.3 mm Thick	
SIZE	DRAWING No.	PSC-4431	
C			
DO NOT SCALE DRAWING		SHEET 2 OF	

JX4 Package Outline and Dimensions

NOTES:
1. ALL DIMENSIONS IN MM.

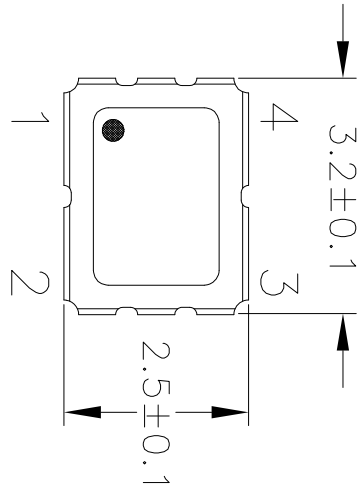

TOP VIEW

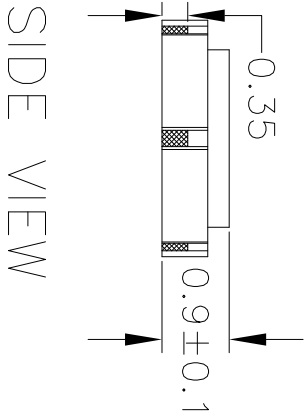

SIDE VIEW

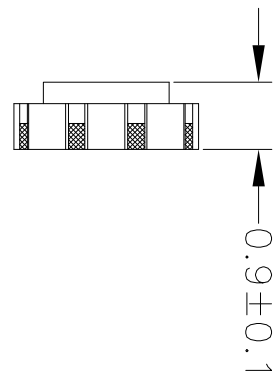

END VIEW

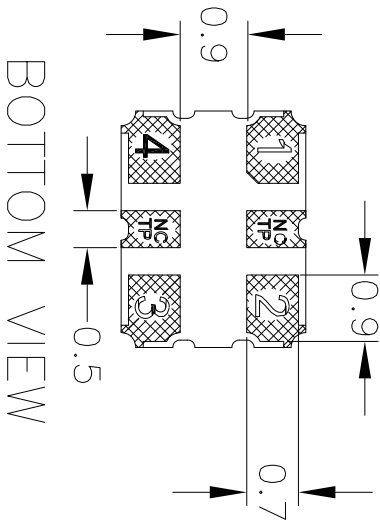

BOTTOM VIEW

REVISIONS		
REV	DESCRIPTION	DATE
00	INITIAL RELEASE	8/8/14

TOLERANCES UNLESS SPECIFIED		 6024 Silver C San Jose, CA PHONE: (408) 448-1000 FAX: (408) 448-1001 www.IDT.com
DECIMAL	ANGULAR	
XX#	±	
XXXX#		
APPROVALS	DATE	TITLE
DRAWN /BAG	8/8/14	JX4 PACKAGE OUTLINE
CHECKED		3.2 x 2.5 mm BODY
		0.9 mm Thick
SIZE	DRAWING No.	
C	PSC-4489	

JX4 Package Outline and Dimensions (cont.)

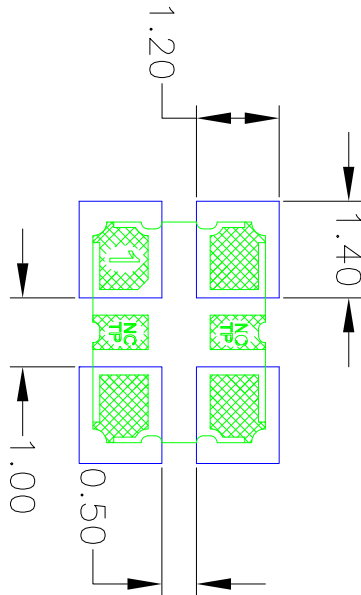

RECOMMENDED LAND PATTERN

NOTES:

1. ALL DIMENSION ARE IN mm. ANGLES IN DEGREES.
2. TOP DOWN VIEW. AS VIEWED ON PCB.
3. COMPONENT OUTLINE SHOW FOR REFERENCE IN GREEN.
4. LAND PATTERN IN BLUE. NSMD PATTERN ASSUMED.
5. LAND PATTERN RECOMMENDATION PER IPC-7351B GENERIC REQUIREMENT FOR SURFACE MOUNT DESIGN AND LAND PATTERN.

REVISIONS		
REV	DESCRIPTION	DATE
00	INITIAL RELEASE	8/8/14
		JJH/A

TOLERANCES UNLESS SPECIFIED		 <p>6024 Silver Creek Valley Rd San Jose, CA 95138 PHONE: (408) 727-6116 FAX: (408) 492-8674</p>
DECIMAL	± ANGULAR	
XXX	±	
XXXX		
APPROVALS	DATE	TITLE
DRAWN <i>QAC</i>	8/8/14	JX4 PACKAGE OUTLINE
CHECKED		3.2 x 2.5 mm BODY
		0.9 mm Thick
SIZE	DRAWING No.	REV
C	P30-4489	00
DO NOT SCALE DRAWING		SHEET 2 OF 2

Ordering Information

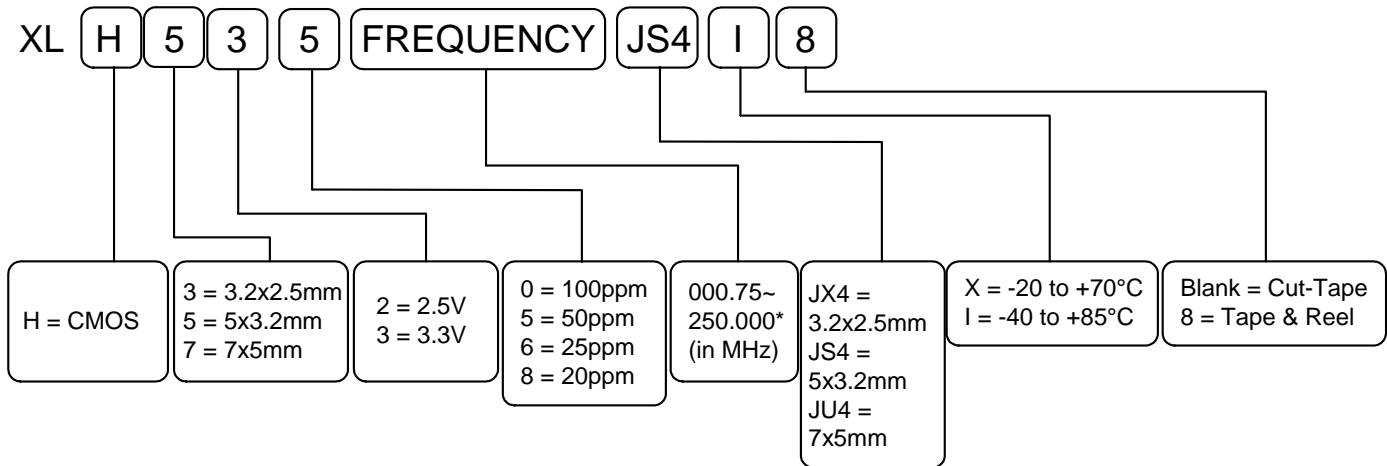

* See table or contact IDT for custom frequencies

Revision History

Rev.	Date	Originator	Description of Change
A	10/01/14	B. Chandhoke	1. Corrected typo in spec for Enable/Disable Low Voltage; from $\geq 30\%VDD$ to $\leq 30\%VDD$. 2. Moved from Advance to Preliminary.
B	12/10/14	B. Chandhoke	1. Added 7 x 5 x 1.3mm JU4 and 3.2 x 2.5 x 1.0mm JX4 package options and package dimension/landing pattern drawings. 2. Updated ordering information table/graphic to show added package options.



Corporate Headquarters
6024 Silver Creek Valley Road
San Jose, CA 95138 USA

Sales
1-800-345-7015 or 408-284-8200
Fax: 408-284-2775
www.IDT.com

Tech Support
email: clocks@idt.com

DISCLAIMER Integrated Device Technology, Inc. (IDT) and its subsidiaries reserve the right to modify the products and/or specifications described herein at any time and at IDT's sole discretion. All information in this document, including descriptions of product features and performance, is subject to change without notice. Performance specifications and the operating parameters of the described products are determined in the independent state and are not guaranteed to perform the same way when installed in customer products. The information contained herein is provided without representation or warranty of any kind, whether express or implied, including, but not limited to, the suitability of IDT's products for any particular purpose, an implied warranty of merchantability, or non-infringement of the intellectual property rights of others. This document is presented only as a guide and does not convey any license under intellectual property rights of IDT or any third parties.

IDT's products are not intended for use in applications involving extreme environmental conditions or in life support systems or similar devices where the failure or malfunction of an IDT product can be reasonably expected to significantly affect the health or safety of users. Anyone using an IDT product in such a manner does so at their own risk, absent an express, written agreement by IDT.

Integrated Device Technology, IDT and the IDT logo are registered trademarks of IDT. Product specification subject to change without notice. Other trademarks and service marks used herein, including protected names, logos and designs, are the property of IDT or their respective third party owners.

Copyright ©2014 Integrated Device Technology, Inc.. All rights reserved.