

# Clamshell BGA Elastomer Socket

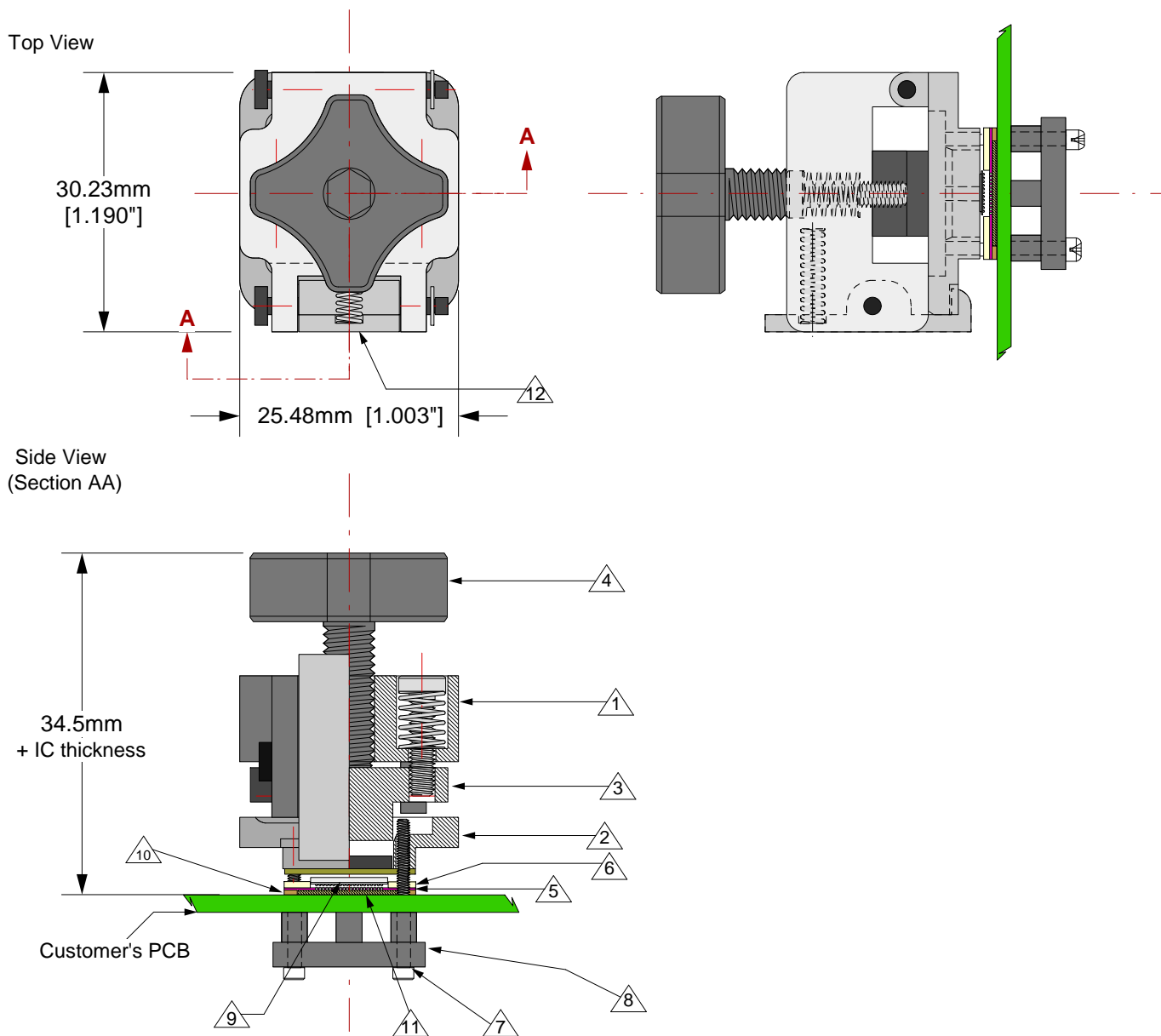

## Features

- Directly mounts to target PCB (needs tooling holes) with hardware
- Minimum real estate required
- Compression plate distributes forces evenly
- Clamshell lid

## Materials:

- 1 Clam Shell Lid: Black anodized Aluminum. Height = 16.5 mm.
- 2 Socket Base: Black anodized Aluminum. Height = 6 mm.
- 3 Compression Plate: Black anodized Aluminum. Thickness = 8.5 mm.
- 4 Compression Screw: Clear anodized Aluminum. Height = 25 mm, Fluted Knob
- 5 Ball Guide: Kapton polyimide.
- 6 IC Guide: Torlon
- 7 Socket Base Screw: Socket Head Cap Screw, alloy steel with black oxide finish, 0-80 Thread, 5/8" long.
- 8 Backing Plate: Black anodized Aluminum. Thickness = 6.35mm
- 9 Customer's BGA IC
- 10 Elastomer Guide: Non-clad FR4. Thickness = 0.735mm.
- 11 Elastomer: 40 micron dia gold plated brass filaments arranged symmetrically in a silicone rubber (63.5 degree angle). Thickness = 0.75mm.
- 12 Latch: Black anodised Aluminum.

	<b>CG-BGA-4011 Drawing</b>	Status: Released	Scale: -	Rev: B
	© 2011 IRONWOOD ELECTRONICS, INC. Tele: (800) 404-0204 www.ironwoodelectronics.com	Drawing: E. Smolentseva		Date: 10/26/11
		File: CG-BGA-4011 Dwg.mcd	Modified: 3/31/14	

All Tolerances: ±0.125mm (unless stated otherwise). Materials and specifications are subject to change without notice.

**\*Note: BGA pattern is not symmetrical with respect to the mounting holes. It is offset by 0.375mm to the right of center with respect to the mounting holes.**

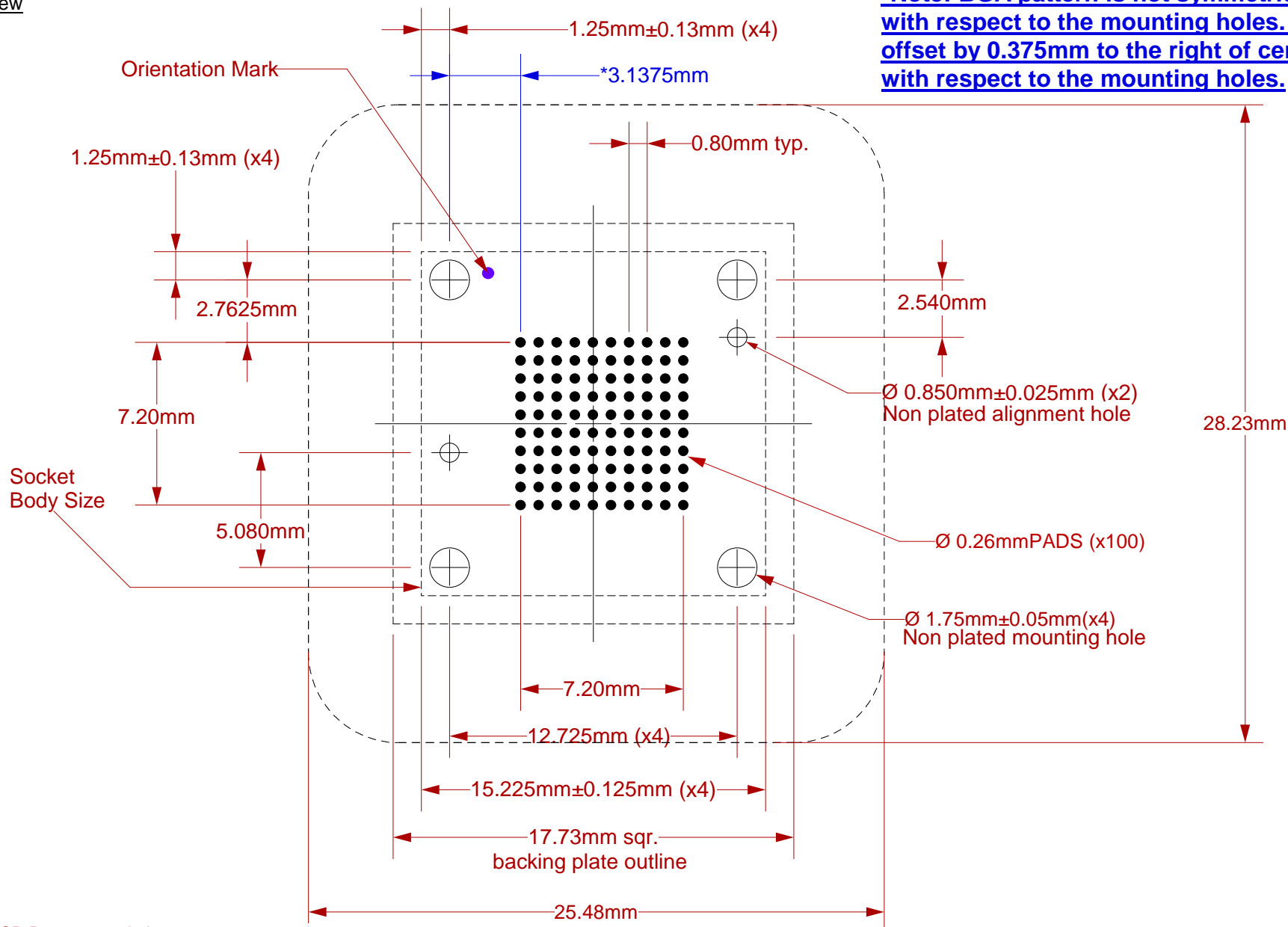

Target PCB Recommendations

Total thickness: 1.6mm min.  
Plating: Gold or Solder finish  
PCB Pad height: Same or higher than solder mask

All dimensions are in mm unless stated otherwise

Recommended PCB Layout  
Tolerances:  $\pm 0.025\text{mm}$  [ $\pm 0.001''$ ]  
unless stated otherwise.

	<b>CG-BGA-4011 Drawing</b>	Status: Released	Scale: -	Rev: B
	© 2011 IRONWOOD ELECTRONICS, INC. Tele: (800) 404-0204 www.ironwoodelectronics.com	Drawing: E. Smolentseva		Date: 10/26/11
		File: CG-BGA-4011 Dwg.mcd	Modified: 3/31/14	

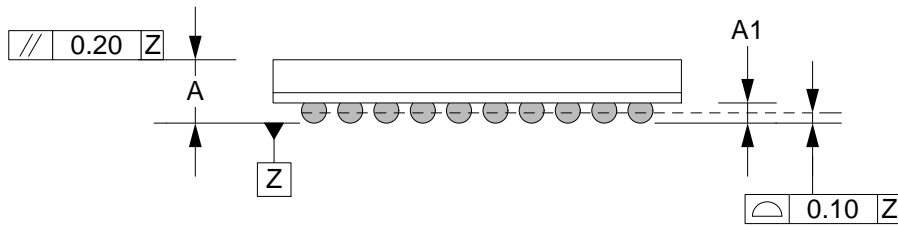
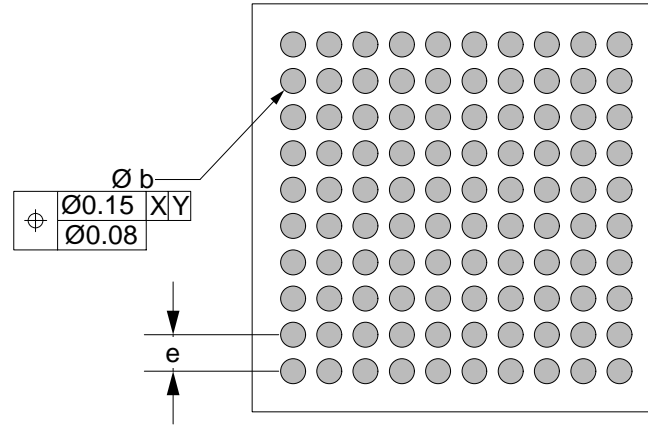
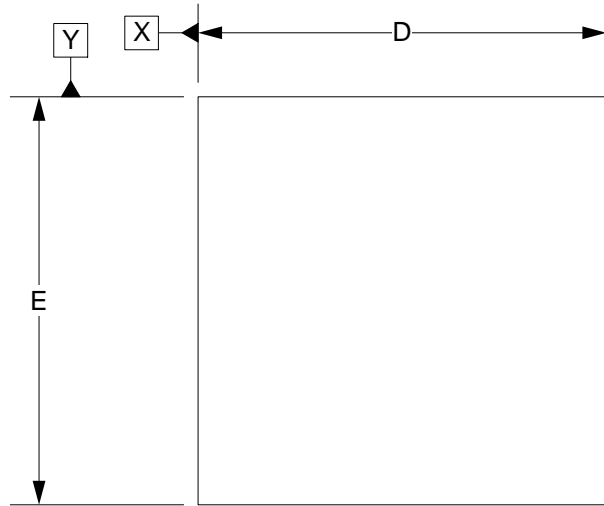

1. Dimensions are in millimeters.
2. Interpret dimensions and tolerances per ASME Y14.5M-1994.

3. Dimension b is measured at the maximum solder ball diameter, parallel to datum plane Z.
4. Datum Z (seating plane) is defined by the spherical crowns of the solder balls.
5. Parallelism measurement shall exclude any effect of mark on top surface of package.

DIM	MIN	MAX
A		1.70
A1	0.25	0.35
b		0.55
D	9.0 BSC	
E	9.0 BSC	
e	0.8 BSC	

	<b>CG-BGA-4011 Drawing</b>	Status: Released	Scale: -	Rev: B
	© 2011 IRONWOOD ELECTRONICS, INC. Tele: (800) 404-0204 www.ironwoodelectronics.com	Drawing: E. Smolentseva		Date: 10/26/11
		File: CG-BGA-4011 Dwg.mcd	Modified: 3/31/14	

Top View

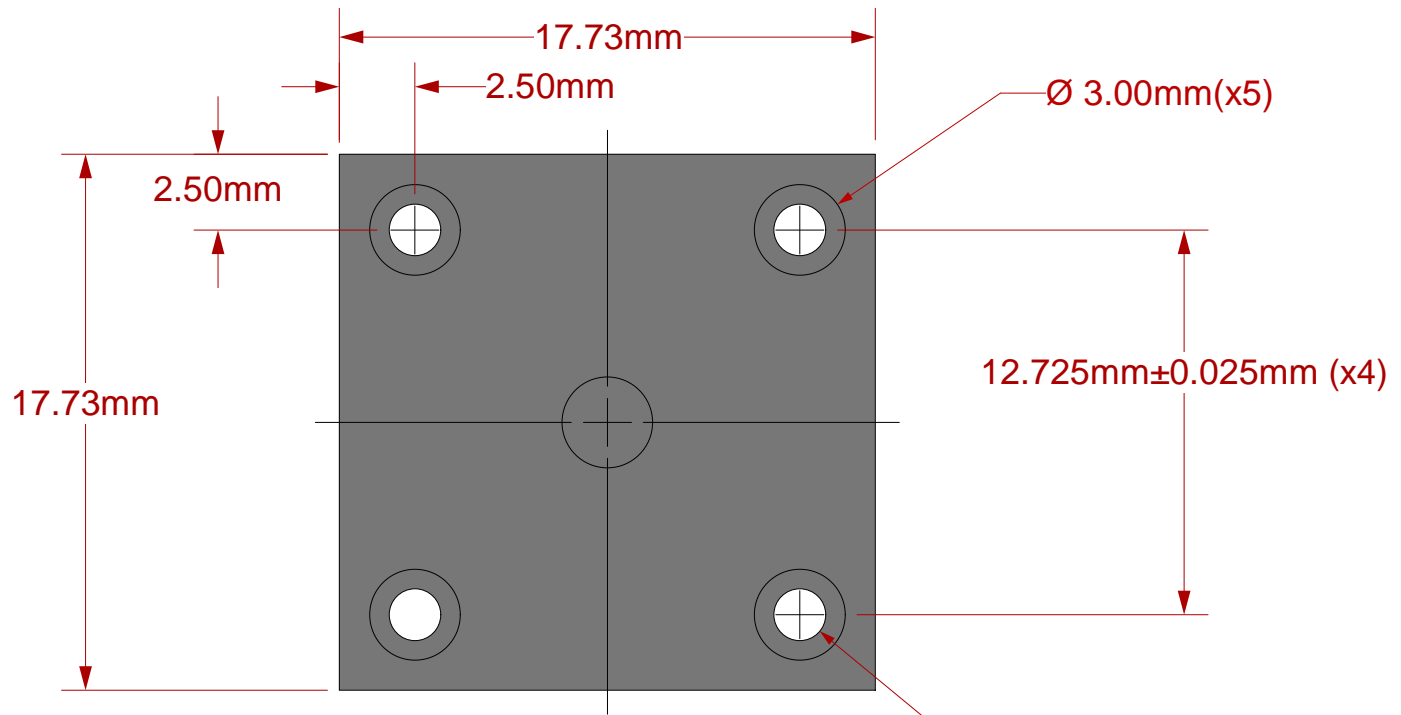

Side View

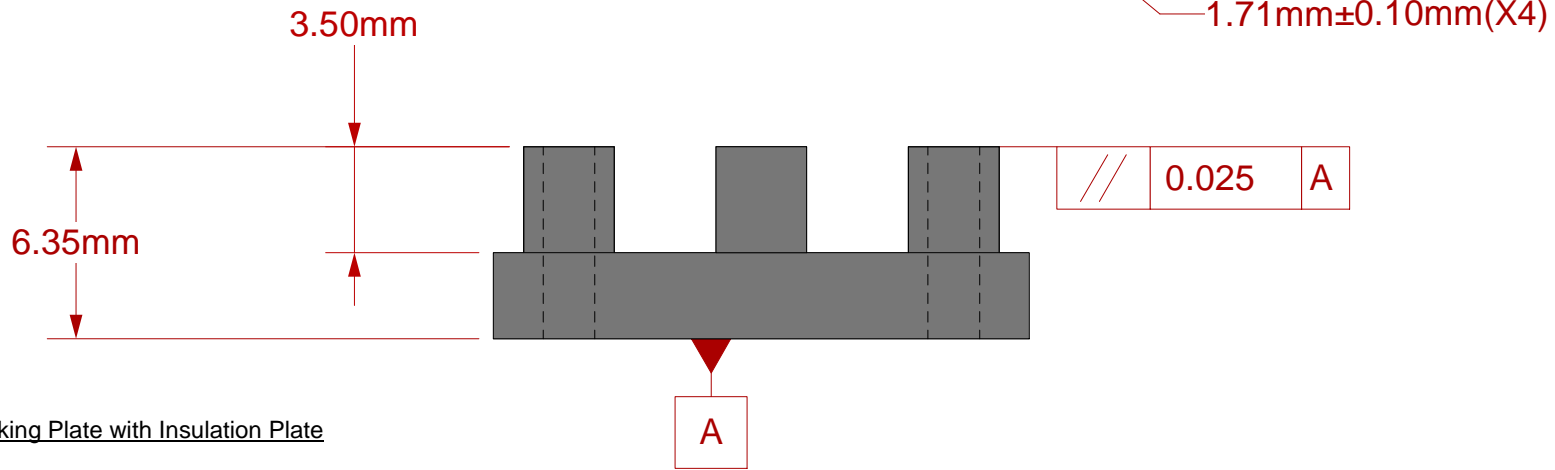

Description: Backing Plate with Insulation Plate

	<b>CG-BGA-4011 Drawing</b>	Status: Released	Scale: -	Rev: B
	© 2011 IRONWOOD ELECTRONICS, INC. Tele: (800) 404-0204 www.ironwoodelectronics.com	Drawing: E. Smolentseva		Date: 10/26/11
		File: CG-BGA-4011 Dwg.mcd	Modified: 3/31/14	

All dimensions are in mm.  
All tolerances are +/- 0.125mm.  
(Unless stated otherwise)