



# MLG3-0870P811

MLG

MEASURING AUTOMATION LIGHT GRIDS

**SICK**  
Sensor Intelligence.



### Ordering information

Type	Part no.
MLG3-0870P811	1042559

Other models and accessories → [www.sick.de/MLG](http://www.sick.de/MLG)



### Detailed technical data

#### Features

<b>Technology</b>	Sender/receiver
<b>Minimum detectable object (MDO)</b>	Parallel beam, 35 mm <sup>1)</sup>
<b>Beam separation</b>	30 mm
<b>Number of beams</b>	≥ 30
<b>Detection height</b>	870 mm
<b>Configuration</b>	GSD data file

<sup>1)</sup> MDO min. detectable object.

#### Performance

<b>Maximum range</b>	7 m <sup>1)</sup>
<b>Minimum range</b>	Parallel beam: ≥ 0 mm
<b>Working range</b>	5 m
<b>Response time</b>	Parallel beam ≥ 5.5 ms <sup>2)</sup>

<sup>1)</sup> No reserve for environmental issue and deterioration of the diode.

<sup>2)</sup> With resistive load.

#### Interfaces

<b>Switching output</b>	1 x PNP
<b>Inputs</b>	1 x PNP
<b>Connection type</b>	Male connector M12, 8-pin
<b>Data interface</b>	PROFIBUS
<b>Fieldbus, industrial network</b>	PROFIBUS DP
<b>Type of fieldbus integration</b>	Integrated in the device

## Mechanics/electronics

<b>Wave length</b>	Infrared light, 880 nm
<b>Supply voltage <math>V_s</math></b>	DC 18 V ... 30 V <sup>1)</sup>
<b>Power consumption sender</b>	$\geq 200$ mA <sup>2)</sup>
<b>Power consumption receiver</b>	$\geq 190$ mA <sup>2)</sup>
<b>Ripple</b>	$< 5$ V <sub>pp</sub>
<b>Output current <math>I_{max}</math></b>	$\leq 100$ mA <sup>3)</sup>
<b>Output load capacitive</b>	100 nF
<b>Output load inductive</b>	1 H
<b>Initialization time</b>	1 s
<b>Dimensions (W x H x D)</b>	34 mm x 964 mm x 29 mm
<b>Housing material</b>	Aluminum
<b>Indication</b>	7-segment display, 7-segment display
<b>Synchronization</b>	Cable
<b>Enclosure rating</b>	IP 65
<b>Circuit protection</b>	$U_V$ connections, reverse polarity protected, Output Q short-circuit protected, Interference pulse suppression
<b>Weight</b>	$\geq 2.501$ kg
<b>Front screen</b>	PMMA

<sup>1)</sup> Without load.

<sup>2)</sup> Without load with 24 V.

<sup>3)</sup> Typical value.

## Ambient data

<b>Protection class</b>	III
<b>EMC</b>	EN 60947-5-2
<b>Ambient temperature</b>	Operation: $-25$ °C ... $+55$ °C Storage: $-40$ °C ... $+70$ °C
<b>Ambient light immunity</b>	Direct: 12,500 lx <sup>1)</sup> Indirect: 50,000 lx <sup>1)</sup>
<b>Vibration resistance</b>	5 g, 10 Hz ... 55 Hz (IEC 68-2-6)
<b>Shock load</b>	10 g / IEC 68-2-29 / 16 ms

<sup>1)</sup> Sunlight.

Dimensional drawing (Dimensions in mm (inch))

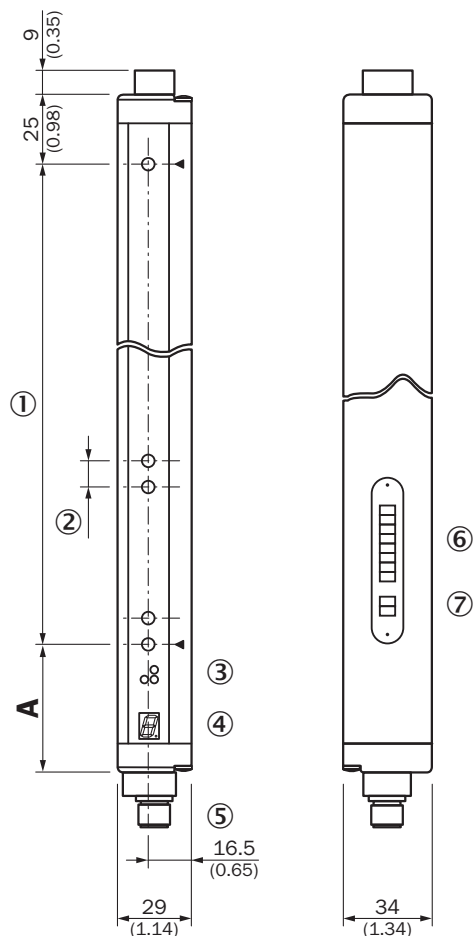

	<b>A</b>
	Distance: MLG edge - first beam
<b>Beam separation 10 mm</b>	49 (1.93)
<b>Beam separation 20 mm</b>	49 (1.93) <sup>1)</sup> / 59 (2.32) <sup>2)</sup>
<b>Beam separation 30 mm</b>	69 (2.72)
<b>Beam separation 50 mm</b>	89 (3.50)

<sup>1)</sup> With even number of beams.  
<sup>2)</sup> With odd number of beams.

- ① Detection height (see optical performance)
- ② Beam separation (10, 20, 30, 50 mm)
- ③ Status indicator: green, yellow, red LEDs
- ④ Indicator panel, 7-segment display
- ⑤ M12 male connector, 8-pin/M12 male connector, 5-pin
- ⑥ Address setting
- ⑦ Bus termination

## Adjustments

LED indicator

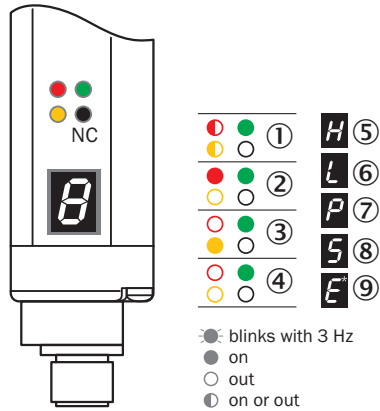





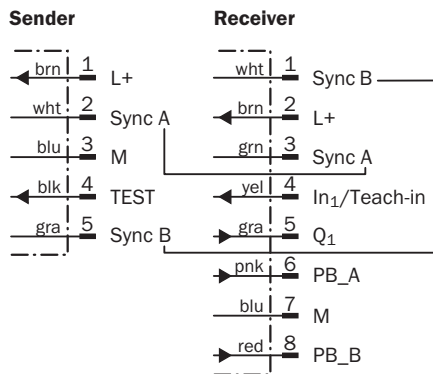
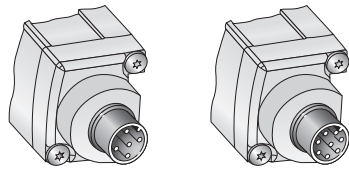





- ① Supply voltage
- ② Device error
- ③ No object in the light path
- ④ Contamination control
- ⑤ Blocked Beams Hold (BBH)
- ⑥ Activated teach-in procedure
- ⑦ ParamMode is active
- ⑧ Standby
- ⑨ Error: E1 = sync. error; E2 = less receiver signal; E9 = defect

## Connection type and diagram



## Recommended accessories

Other models and accessories → [www.sick.de/MLG](http://www.sick.de/MLG)

	Brief description	Type	Part no.
<b>Mounting brackets and mounting plates</b>			
	Side mounting with T-nuts, 4 pieces, mounting hardware included	BEF-NUT-MLG	2023696
<b>Terminal and alignment brackets</b>			
	4 pieces, Mounting kit 1, rotatable, swivel mount, plastic	BEF-2SMKEAKU4	2019649
<b>Adapters and distributors</b>			
	Male connector M12, 5-pin, straight, A-coded to 2 x female connector M12, 5-pin, straight, A-coded	SBO-02G12-SM	6029305
<b>Plug connectors and cables</b>			
	Head A: female connector, M12, 5-pin, straight Head B: cable Cable: PROFIBUS DP, PUR, halogen-free, shielded, 5 m	DOL-1205-G05MQ	6026006
	Head A: female connector, M12, 5-pin, straight Head B: cable Cable: PVC, unshielded, 10 m	DOL-1205-G10M	6010544
	Head A: female connector, M12, 5-pin, straight Head B: cable Cable: PROFIBUS DP, PVC, shielded, 10 m	DOL-1205-G10MQ	6026008
	Head A: female connector, M12, 5-pin, straight Head B: cable Cable: PVC, unshielded, 15 m	DOL-1205-G15M	6029215
	Head A: female connector, M12, 5-pin, angled Head B: cable Cable: PVC, unshielded, 2 m	DOL-1205-W02M	6008900
	Head A: female connector, M12, 5-pin, angled Head B: cable Cable: PVC, unshielded, 5 m	DOL-1205-W05M	6009869
	Head A: female connector, M12, 5-pin, angled Head B: cable Cable: PVC, unshielded, 10 m	DOL-1205-W10M	6010542
	Head A: male connector, M12, 5-pin, straight, B-coded Head B: cable Cable: PROFIBUS DP, drag chain use, PUR, halogen-free, shielded, 5 m Wire shield Al-Pt film, overall shield C-screen tin-plated	STL-1205-G05MQ	6026005
	Head A: male connector, M12, 5-pin, straight, B-coded Head B: cable Cable: PROFIBUS DP, drag chain use, PUR, halogen-free, shielded, 10 m Wire shield Al-Pt film, overall shield C-screen tin-plated	STL-1205-G10MQ	6026007
	Head A: female connector, M12, 5-pin, straight, A-coded Head B: male connector, M12, 5-pin, straight, A-coded Cable: digital I/Os, drag chain use, PUR, halogen-free, unshielded, 5 m	DSL-1205-G05MC	6029282
	Head A: female connector, M12, 5-pin, straight, A-coded Head B: male connector, M12, 5-pin, straight, A-coded Cable: digital I/Os, drag chain use, PUR, halogen-free, unshielded, 10 m	DSL-1205-G10MC	6038954

	<b>Brief description</b>	<b>Type</b>	<b>Part no.</b>
	<p>Head A: female connector, M12, 8-pin, straight                      Head B: male connector, M12, 5-pin, angled                      Cable: PROFIBUS DP, PUR, shielded, 0.3 m                      PROFIBUS-DP adapter cable (PROFIBUS IN, PROFIBUS OUT, and voltage supply, Q1)</p>	<p>ADAPT-PB-WI-MLG</p>	<p>1027901</p>

## SICK AT A GLANCE

SICK is one of the leading manufacturers of intelligent sensors and sensor solutions for industrial applications. A unique range of products and services creates the perfect basis for controlling processes securely and efficiently, protecting individuals from accidents and preventing damage to the environment.

We have extensive experience in a wide range of industries and understand their processes and requirements. With intelligent sensors, we can deliver exactly what our customers need. In application centers in Europe, Asia and North America, system solutions are tested and optimized in accordance with customer specifications. All this makes us a reliable supplier and development partner.

Comprehensive services complete our offering: SICK LifeTime Services provide support throughout the machine life cycle and ensure safety and productivity.

For us, that is “Sensor Intelligence.”

## WORLDWIDE PRESENCE:

Contacts and other locations –[www.sick.com](http://www.sick.com)