

NICHIA CORPORATION

SPECIFICATIONS FOR WHITE LED

NJCWS024Z-M2

- Built-in ESD Protection Device
- RoHS Compliant

SPECIFICATIONS

(1) Absolute Maximum Ratings

Item	Symbol	Absolute Maximum Rating	Unit
Forward Current	I_F	1000	mA
Pulse Forward Current	I_{FP}	1500	mA
Allowable Reverse Current	I_R	85	mA
Power Dissipation	P_D	38.7	W
Operating Temperature	T_{opr}	-40~105	°C
Storage Temperature	T_{stg}	-40~100	°C
Junction Temperature	T_J	150	°C

* Absolute Maximum Ratings at $T_C=25^\circ\text{C}$.

* I_{FP} conditions with pulse width $\leq 10\text{ms}$ and duty cycle $\leq 10\%$.

* The operating Temperature (T_{opr}) range is the range of case temperatures.

(2) Initial Electrical/Optical Characteristics

Item	Symbol	Condition	Typ	Max	Unit
Forward Voltage	V_F	$I_F=500\text{mA}$	35.8	-	V
Luminous Flux	Φ_v	$I_F=500\text{mA}$	1190	-	lm
Chromaticity Coordinate	x	$I_F=500\text{mA}$	0.3360	-	-
	y	$I_F=500\text{mA}$	0.3335	-	-
Thermal Resistance	$R_{\theta JC}$	-	1.14	1.25	°C/W

* Characteristics at $T_C=25^\circ\text{C}$.

* Luminous Flux value as per CIE 127:2007 standard.

* Chromaticity Coordinates as per CIE 1931 Chromaticity Chart.

* $R_{\theta JC}$ is Thermal Resistance from junction to T_C measuring point.

RANKS

Item	Rank	Min	Max	Unit
Forward Voltage	-	33.0	38.7	V
Luminous Flux	Q0107	1070	1310	lm

Color Rank

		Rank smc53
Center Point	x	0.3360
	y	0.3335

- * Ranking at $T_c=25^\circ\text{C}$.
- * Forward Voltage Tolerance: $\pm 0.35\text{V}$
- * Luminous Flux Tolerance: $\pm 7\%$
- * Chromaticity Coordinate Tolerance: ± 0.005
- * The color rank has a chromaticity range within a 3-step MacAdam ellipse.

CHROMATICITY DIAGRAM

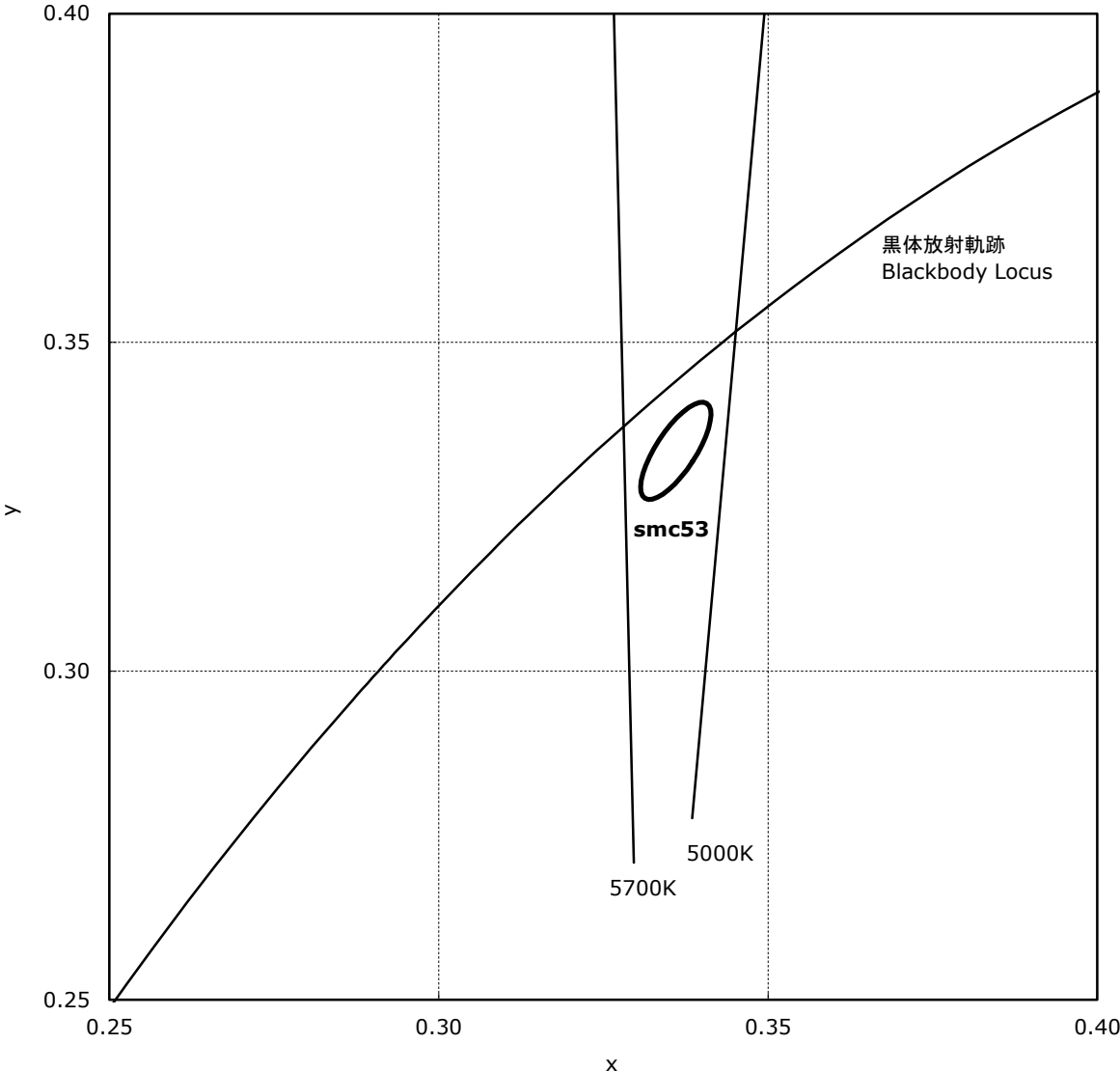

OUTLINE DIMENSIONS

* 本製品はRoHS指令に適合しております。
This product complies with RoHS Directive.

NJCxS024x
管理番号 No. STS-DA7-7286A

* 括弧で囲まれた寸法は参考値です。
The dimension(s) in parentheses are for reference purposes.

(単位 Unit: mm, 公差 Tolerance: ±0.3)

発光部中心の位置精度 ±0.3mm
The center of emitting area to be centered ±0.3mm.

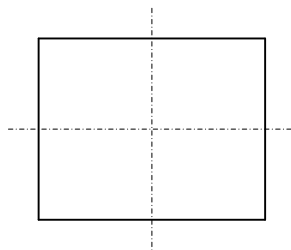
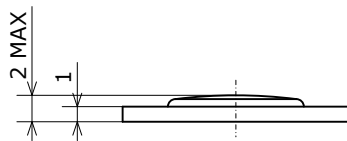
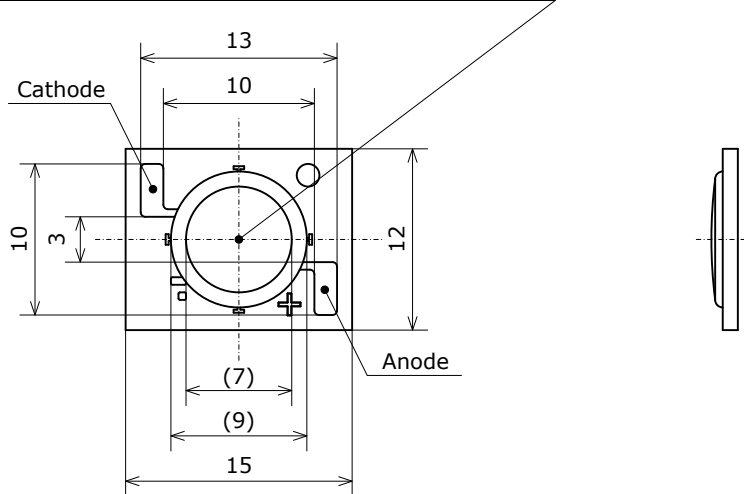

項目 Item	内容 Description
パッケージ材質 Package Materials	セラミックス Ceramics
封止樹脂材質 Encapsulating Resin Materials	シリコン樹脂 (拡散剤+蛍光体入り) Silicone Resin (with diffuser and phosphor)
電極材質 Electrodes Materials	金メッキ Au-plated
質量 Weight	0.66g(TYP)

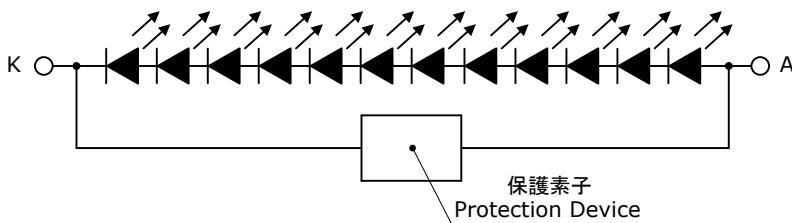

SOLDERING

- Recommended Hand Soldering Condition

Temperature	380°C Max
Soldering Time	5sec Max

- * Hand soldering must not be performed more than once.
- * Since the silicone used in the encapsulating resin frame is soft, do not press on the encapsulating resin frame or resin area. Pressure can cause nicks, chip-outs, encapsulant delamination and deformation, and wire breaks, decreasing reliability.
- * Repairing should not be done after the LEDs have been soldered.
It should be confirmed beforehand whether the characteristics of the LEDs will or will not be damaged by repairing.
- * When soldering, do not apply stress to the LED while the LED is hot.
- * When using a pick and place machine, choose an appropriate nozzle for this product. Using a pick-and-place nozzle with a smaller diameter than the size of the LED's emitting surface will cause damage to the emitting surface and may also cause the LED not to illuminate.
- * When flux is used, it should be a halogen free flux. Ensure that the manufacturing process is not designed in a manner where the flux will come in contact with the LEDs.
- * During and/or after soldering an electric wire to the electrode, ensure that tension is not applied to the electric wire. This may cause the electrode to be damaged and/or reduce the adhesive strength of the electrode to the package.
- * If soldering is used to join electric wires to the electrodes, the adhesive strength of the electrode to the package may be reduced depending on the substances that are found in the solder paste and/or the type of the wire cover that is used. Ensure that there are no issues with the materials that will be used in the chosen application prior to use.

TRAY DIMENSIONS

* 数量は1トレイにつき 80個入りです。
 Tray Size: 80pcs

NxxxS024x
 管理番号 No. STS-DA7-7287

* 寸法は参考です。
 All dimensions shown are for reference only and are not guaranteed.

(単位 Unit: mm)

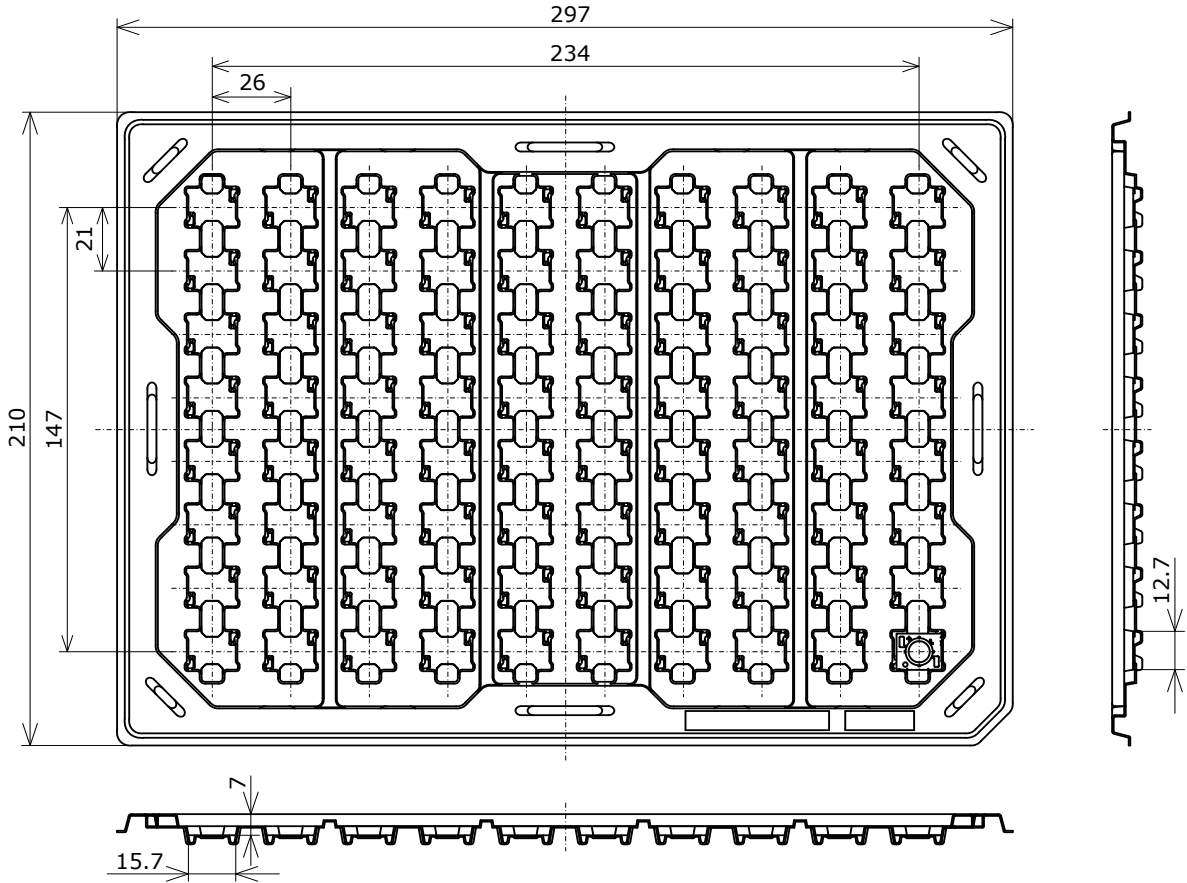

PACKAGING - TRAY PACK

シリカゲルとともにトレイをアルミ防湿袋に入れ、熱シールにより封をします。
Trays are shipped with desiccants in heat-sealed moisture-proof bags.

Nxxxxxxx
管理番号 No. STS-DA7-5106

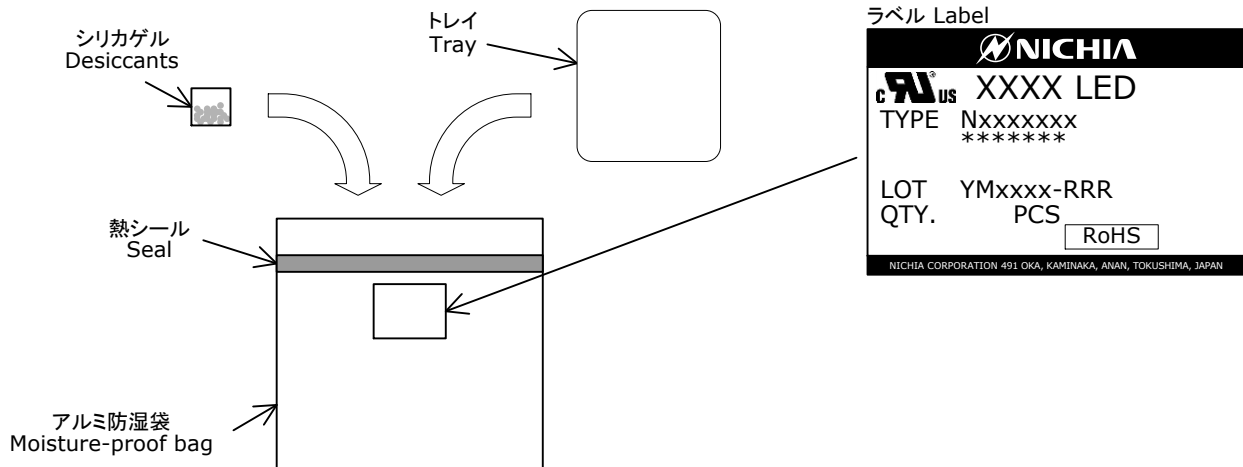

アルミ防湿袋を並べて入れ、ダンボールで仕切ります。
Moisture-proof bags are packed in cardboard boxes with corrugated partitions.

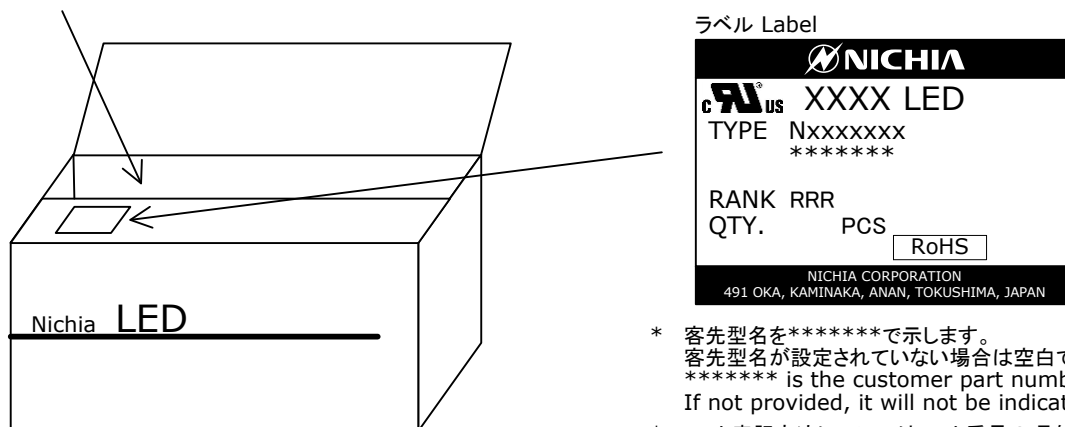

- * 客先型名を*****で示します。
客先型名が設定されていない場合は空白です。
***** is the customer part number.
If not provided, it will not be indicated on the label.
- * ロット表記方法についてはロット番号の項を参照して下さい。
For details, see "LOT NUMBERING CODE" in this document.

- * 本製品はトレイに入れたのち、輸送の衝撃から保護するためダンボールで梱包します。
Products shipped on trays are packed in a moisture-proof bag.
They are shipped in cardboard boxes to protect them from external forces during transportation.
- * 取り扱いに際して、落下させたり、強い衝撃を与えたりしますと、製品を損傷させる原因になりますので注意して下さい。
Do not drop or expose the box to external forces as it may damage the products.
- * ダンボールには防水加工がされておりませんので、梱包箱が水に濡れないよう注意して下さい。
Do not expose to water. The box is not water-resistant.
- * 輸送、運搬に際して弊社よりの梱包状態あるいは同等の梱包を行って下さい。
Using the original package material or equivalent in transit is recommended.

LOT NUMBERING CODE

Lot Number is presented by using the following alphanumeric code.

YMxxxx - RRR

Y - Year

Year	Y
2014	E
2015	F
2016	G
2017	H
2018	I
2019	J

M - Month

Month	M	Month	M
1	1	7	7
2	2	8	8
3	3	9	9
4	4	10	A
5	5	11	B
6	6	12	C

xxxx-Nichia's Product Number

RRR-Ranking by Color Coordinates, Ranking by Luminous Flux

DERATING CHARACTERISTICS

NJCxS024Z-Mx
管理番号 No. STS-DA7-7666

ケース温度測定部温度-許容順電流特性
Temperature at Measure Point on a Case vs
Allowable Forward Current

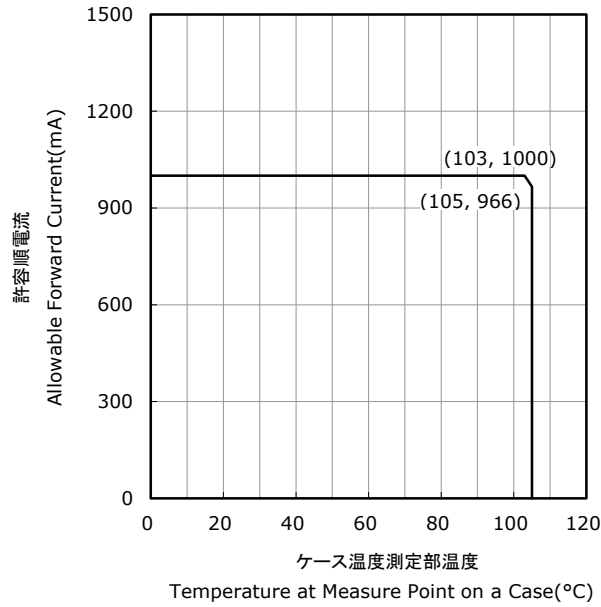

デューティー比-許容順電流特性
Duty Ratio vs
Allowable Forward Current

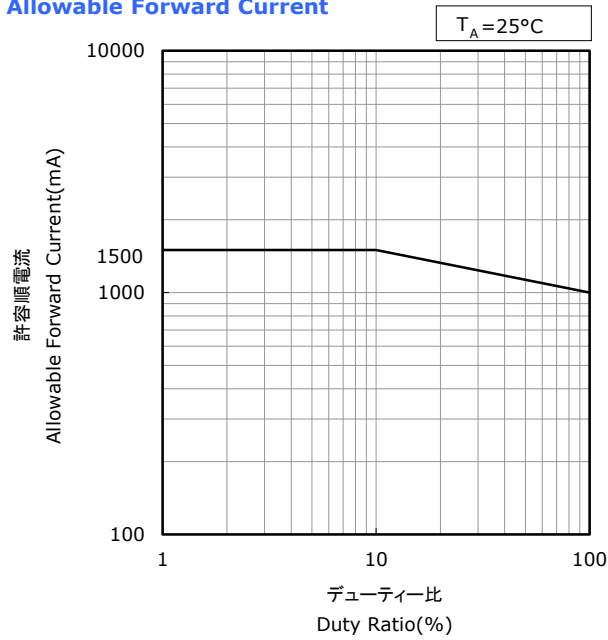

OPTICAL CHARACTERISTICS

* 本特性は参考です。
All characteristics shown are for reference only and are not guaranteed.

NJCWS024Z-M2
管理番号 No. STS-DA7-7767

発光スペクトル Spectrum

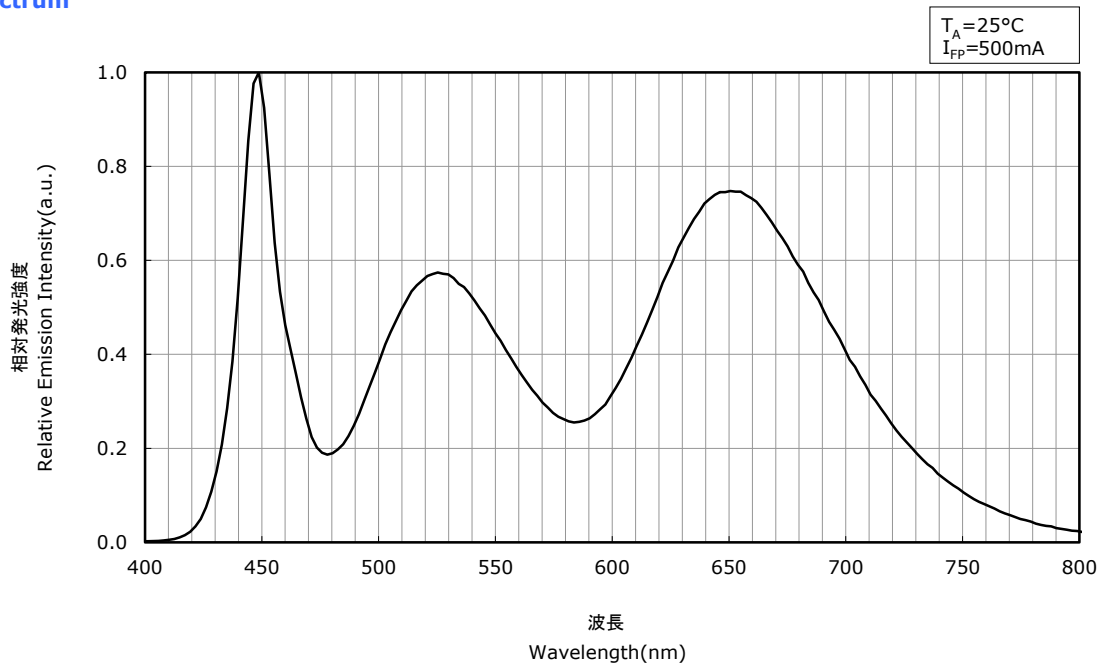

指向特性 Directivity

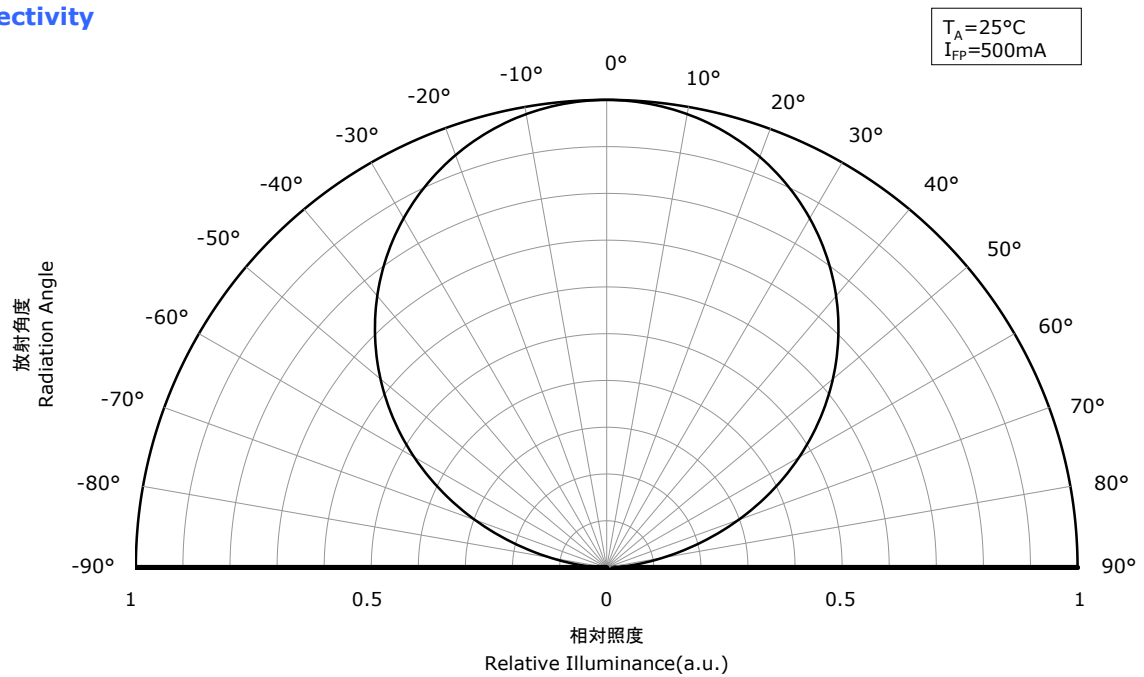

FORWARD CURRENT CHARACTERISTICS / TEMPERATURE CHARACTERISTICS

* 本特性は参考です。
All characteristics shown are for reference only and are not guaranteed.

NJCWS024Z-M2
管理番号 No. STS-DA7-7770

順電圧-順電流特性
Forward Voltage vs
Forward Current

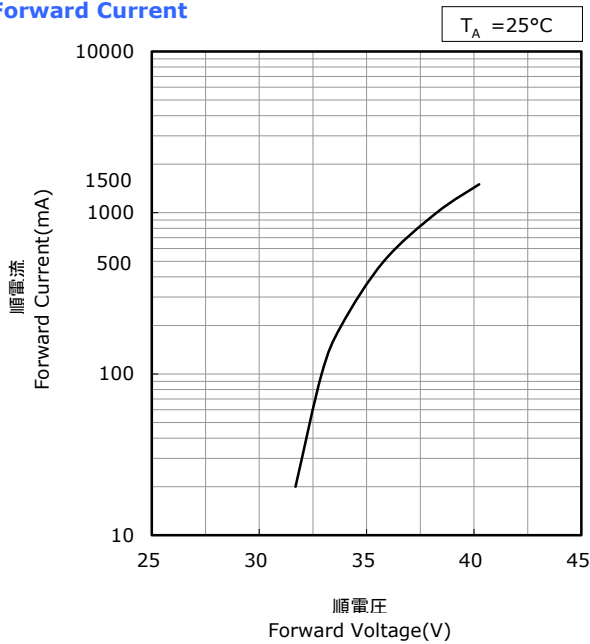

周囲温度-順電圧特性
Ambient Temperature vs
Forward Voltage

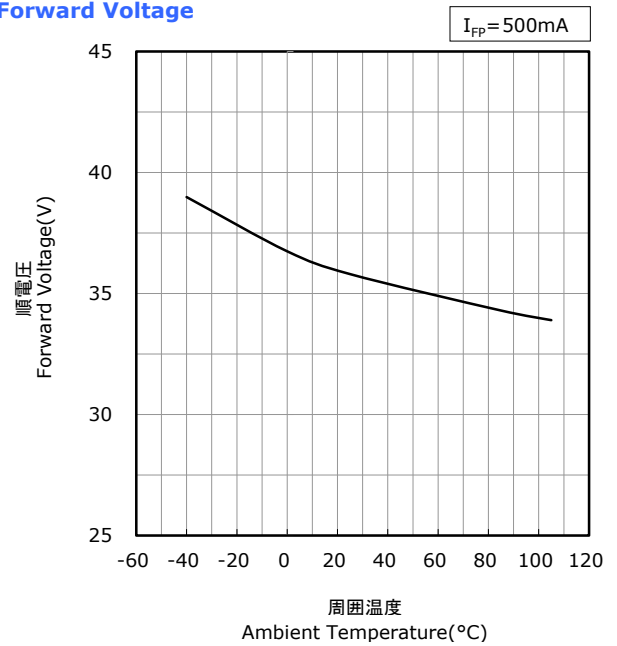

順電流-相対光束特性
Forward Current vs
Relative Luminous Flux

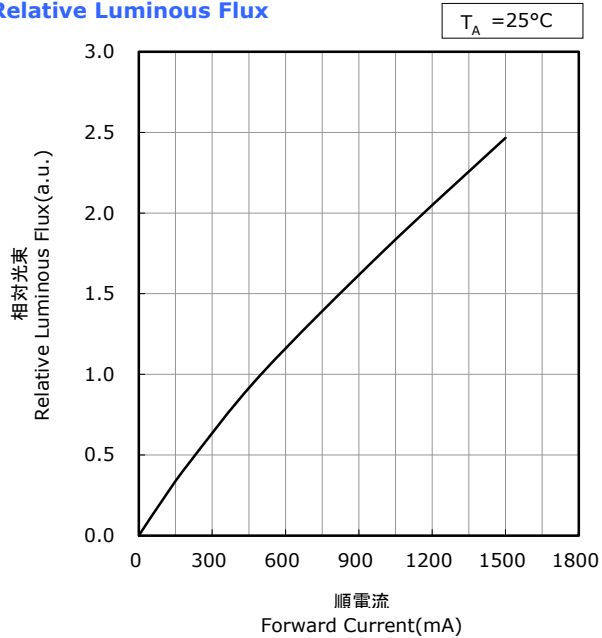

周囲温度-相対光束特性
Ambient Temperature vs
Relative Luminous Flux

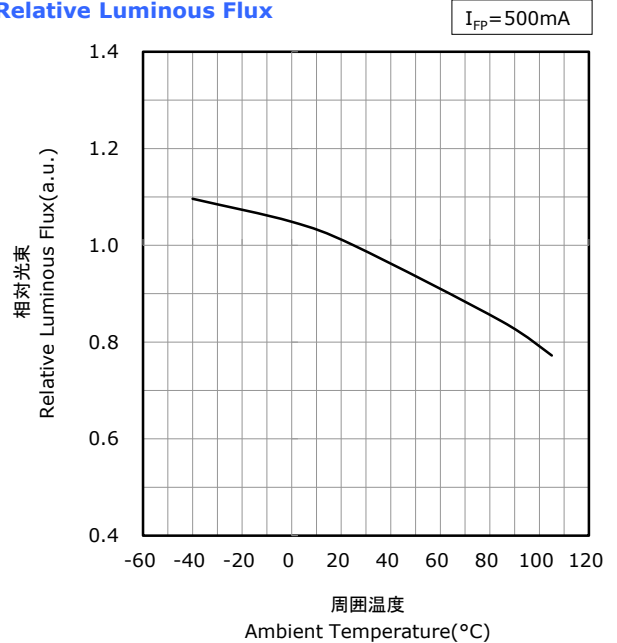

FORWARD CURRENT CHARACTERISTICS / TEMPERATURE CHARACTERISTICS

* 本特性は参考です。
All characteristics shown are for reference only and are not guaranteed.

NJCWS024Z-M2
管理番号 No. STS-DA7-7771

順電流-色度 特性
Forward Current vs Chromaticity Coordinate

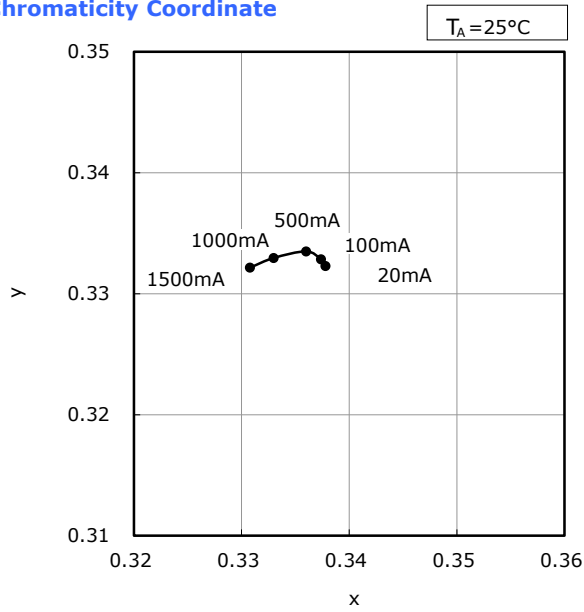

周囲温度-色度 特性
Ambient Temperature vs Chromaticity Coordinate

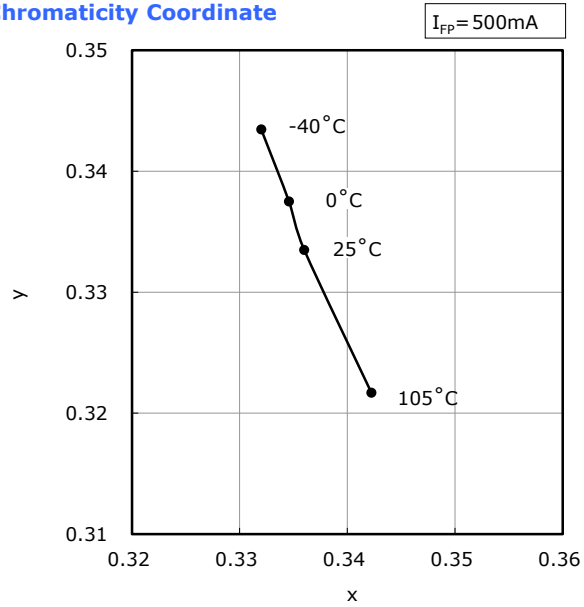

RELIABILITY

(1) Tests and Results

Test	Reference Standard	Test Conditions	Test Duration	Failure Criteria #	Units Failed/Tested
Temperature Cycle	JEITA ED-4701 100 105	-40°C(30min)~25°C(5min)~ 100°C(30min)~25°C(5min)	100cycles	#1	0/10
High Temperature Storage	JEITA ED-4701 200 201	T _A =100°C	1000hours	#1	0/10
Temperature Humidity Storage	JEITA ED-4701 100 103	T _A =60°C, RH=90%	1000hours	#1	0/10
Low Temperature Storage	JEITA ED-4701 200 202	T _A =-40°C	1000hours	#1	0/10
High Temperature Operating Life		T _C =103°C, I _F =1000mA	1000hours	#1	0/10
Electrostatic Discharges	JEITA ED-4701 300 304	HBM, 2kV, 1.5kΩ, 100pF, 3pulses, alternately positive or negative		#1	0/10

NOTES:

Measurements are performed after allowing the LEDs to return to room temperature.

(2) Failure Criteria

Criteria #	Items	Conditions	Failure Criteria
#1	Forward Voltage(V _F)	I _F =500mA	>Initial value×1.1
	Luminous Flux(Φ _v)	I _F =500mA	<Initial value×0.7

CAUTIONS

(1) Storage

Conditions		Temperature	Humidity	Time
Storage	Before Opening Aluminum Bag	≤30°C	≤90%RH	Within 1 Year from Delivery Date
	After Opening Aluminum Bag	≤30°C	≤70%RH	≤168hours

- After opening the moisture-proof aluminum bag, the products should go through the soldering process within the range of the conditions stated above. Unused remaining LEDs should be stored with silica gel desiccants in a hermetically sealed container, preferably the original moisture-proof bags for storage.
- Although the leads or electrode pads (anode and cathode) of the product are plated with gold, prolonged exposure to a corrosive environment might cause the gold plated the leads or electrode pads to tarnish. If unused LEDs remain, they must be stored in a hermetically sealed container. Nichia recommends using the original moisture-proof bag for storage.
- Do not use sulfur-containing materials in commercial products. Some materials, such as seals and adhesives, may contain sulfur. The contaminated plating of LEDs might cause an open circuit. Silicone rubber is recommended as a material for seals. Bear in mind, the use of silicones may lead to silicone contamination of electrical contacts inside the products, caused by low molecular weight volatile siloxane.
- To prevent water condensation, please avoid large temperature and humidity fluctuations for the storage conditions.
- Do not store the LEDs in a dusty environment.
- Do not expose the LEDs to direct sunlight and/or an environment where the temperature is higher than normal room temperature.

(2) Directions for Use

- When designing a circuit, the current through each LED must not exceed the Absolute Maximum Rating. Operating at a constant current per LED is recommended. In case of operating at a constant voltage, Circuit B is recommended. If the LEDs are operated with constant voltage using Circuit A, the current through the LEDs may vary due to the variation in Forward Voltage characteristics of the LEDs.



- This product should be operated using forward current. Ensure that the product is not subjected to either forward or reverse voltage while it is not in use. In particular, subjecting it to continuous reverse voltage may cause migration, which may cause damage to the LED die. When used in displays that are not used for a long time, the main power supply should be switched off for safety.
- Pulse width modulation (PWM) is recommended for dimming LEDs as color point changes with drive current.
- It is recommended to operate the LEDs at a current greater than 10% of the sorting current to stabilize the LED characteristics.
- Ensure that excessive voltages such as lightning surges are not applied to the LEDs.
- For outdoor use, necessary measures should be taken to prevent water, moisture and salt air damage.

(3) Handling Precautions

- Do not handle the LEDs with bare hands as it will contaminate the LED surface and may affect the optical characteristics: it might cause the LED to be deformed and/or the wire to break, which will cause the LED not to illuminate.
- When handling the product with tweezers, be careful not to apply excessive force to the resin. Otherwise, The resin can be cut, chipped, delaminate or deformed, causing wire-bond breaks and catastrophic failures.
- Dropping the product may cause damage.
- Do not stack assembled the products. Failure to comply can cause the resin portion of the product to be cut, chipped, delaminated and/or deformed. It may cause wire to break, leading to catastrophic failures.

(4) Design Consideration

- Volatile organic compounds that have been released from materials present around the LEDs (e.g. housing, packing, adhesive, secondary lens, lens cover, etc.) may penetrate the LED lens and/or encapsulating resin.
If the LEDs are being used in a hermetically sealed environment, these volatile compounds can discolor after being exposed to heat and/or photon energy and it may greatly reduce the LED light output and/or cause a color shift.
In this case, ventilating the environment may improve the reduction in light output and/or color shift.
Perform a light-up test of the chosen application for optical evaluation to ensure that there are no issues, especially if the LEDs are planned to be used in a hermetically sealed environment.
- Excessive forces on this product can cause the ceramic package to crack.
It is recommended to use a holder when fixing this product to a chassis.
- It is recommended to use a thermal film or thermal grease between the product and a chassis for increased heat dissipation.

(5) Electrostatic Discharge (ESD)

- The products are sensitive to static electricity or surge voltage. ESD can damage a die and its reliability.
When handling the products, the following measures against electrostatic discharge are strongly recommended:
Eliminating the charge
Grounded wrist strap, ESD footwear, clothes, and floors
Grounded workstation equipment and tools
ESD table/shelf mat made of conductive materials
- Ensure that tools (e.g. soldering irons), jigs and machines that are being used are properly grounded and that proper grounding techniques are used in work areas. For devices/equipment that mount the LEDs, protection against surge voltages should also be used.
- If tools or equipment contain insulating materials such as glass or plastic, the following measures against electrostatic discharge are strongly recommended:
Dissipating static charge with conductive materials
Preventing charge generation with moisture
Neutralizing the charge with ionizers

(6) Thermal Management

- Proper thermal management is an important when designing products with LEDs. LED die temperature is affected by LED module thermal resistance and LED spacing. Please design products in a way that the LED die temperature does not exceed the maximum Junction Temperature (T_J).
- The dice temperature of the products should be calculated, using the case temperature (T_C) of the product incorporated into the end-product, by the following equation.

$$T_J = T_C + R_{\theta JC} \cdot W$$

* T_J = LED junction temperature: °C

T_C = Case temperature: °C

$R_{\theta JC}$ = Thermal resistance from junction to T_C measuring point: °C/W

W = Input power ($I_F \times V_F$): W

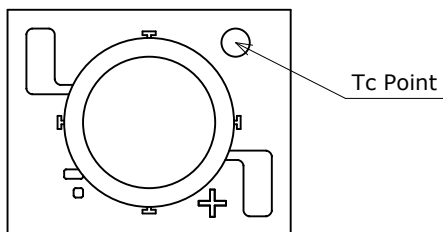

(7) Cleaning

- The LEDs should not be cleaned with water, benzine, and/or thinner.
- If required, isopropyl alcohol (IPA) should be used. Other solvents may cause premature failure to the LEDs due to the damage to the resin portion. The effects of such solvents should be verified prior to use.
In addition, the use of CFCs such as Freon is heavily regulated.
- When dust and/or dirt adheres to the LEDs, soak a cloth with Isopropyl alcohol (IPA), then squeeze it before wiping the LEDs.
- Ultrasonic cleaning is not recommended since it may have adverse effects on the LEDs depending on the ultrasonic power and how LED is assembled.
If ultrasonic cleaning must be used, the customer is advised to make sure the LEDs will not be damaged prior to cleaning.

(8) Eye Safety

- In 2006, the International Electrical Commission (IEC) published IEC 62471:2006 Photobiological safety of lamps and lamp systems, which added LEDs in its scope.
On the other hand, the IEC 60825-1:2007 laser safety standard removed LEDs from its scope.
However, please be advised that some countries and regions have adopted standards based on the IEC laser safety standard IEC 60825-1:2011/2001, which still includes LEDs in its scope.
Most of Nichia's LEDs can be classified as belonging into either the Exempt Group or Risk Group 1.
High-power LEDs, that emit light containing blue wavelengths, may be classified as Risk Group 2.
Please proceed with caution when viewing directly any LEDs driven at high current, or viewing LEDs with optical instruments which may greatly increase the damages to your eyes.
- Viewing a flashing light may cause eye discomfort. When incorporating the LED into your product, please be careful to avoid adverse effects on the human body caused by light stimulation.

(9) Others

- The LEDs described in this brochure are intended to be used for ordinary electronic equipment (such as office equipment, communications equipment, measurement instruments and household appliances).
Consult Nichia's sales staff in advance for information on the applications in which exceptional quality and reliability are required, particularly when the failure or malfunction of the LEDs may directly jeopardize life or health (such as for airplanes, aerospace, submersible repeaters, nuclear reactor control system, automobiles, traffic control equipment, life support systems and safety devices).
- The customer shall not reverse engineer by disassembling or analysis of the LEDs without having prior written consent from Nichia. When defective LEDs are found, the customer shall inform Nichia directly before disassembling or analysis.
- The specifications and appearance of this product may change without notice;
Nichia does not guarantee the contents of this specification. Both the customer and Nichia will agree on the official specifications of supplied products before the volume production of a program begins.