

Product Summary

$V_{(BR)DSS}$	$R_{DS(ON)}$	I_D $T_A = 25^\circ C$
60V	3.0Ω @ $V_{GS} = 10V$	400mA
	4.0Ω @ $V_{GS} = 5V$	330mA

Description and Applications

These N-Channel enhancement mode field effect transistors are produced using DIODES proprietary, high density, uses advanced trench technology. These products have been designed to minimize on-state resistance while provide rugged, reliable, and fast switching performance. These products are particularly suited for low voltage, low current applications such as small

- Load switching

Features and Benefits

- N-Channel MOSFET
- Low On-Resistance
- Low Gate Threshold Voltage
- Low Input Capacitance
- Fast Switching Speed
- Small Surface Mount Package
- ESD Protected Gate, 1.2kV HBM
- Lead, Halogen and Antimony Free, RoHS Compliant
- "Green" Device (Notes 1 and 2)
- Qualified to AEC-Q101 Standards for High Reliability

Mechanical Data

- Case: DFN1006-3
- Case Material: Molded Plastic, "Green" Molding Compound. UL Flammability Classification Rating 94V-0
- Moisture Sensitivity: Level 1 per J-STD-020
- Terminal Connections: See Diagram
- Terminals: Finish – NiPdAu over Copper leadframe. Solderable per MIL-STD-202, Method 208
- Weight: 0.001 grams (approximate)

DFN1006-3



Top View

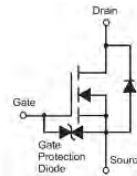

Equivalent Circuit



Top View

Ordering Information (Note 3)

Part Number	Case	Packaging
2N7002XFB-7	DFN1006-3	3000/Tape & Reel

- Notes:
1. No purposefully added lead. Halogen and Antimony Free.
 2. Product manufactured with Data Code V9 (week 33, 2008) and newer are built with Green Molding Compound. Product manufactured prior to Date Code V9 are built with Non-Green Molding Compound and may contain Halogens or Sb203 Fire Retardants.
 3. For packaging details, go to our website at <http://www.diodes.com>

Marking Information

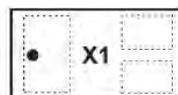

Top View
Dot Denotes
Drain Side

X1 = Product Type Marking Code

Date Code Key

Year	2009	2010	2011	2012	2013	2014	2015
Code	W	X	Y	Z	A	B	C

Month	Jan	Feb	Mar	Apr	May	Jun	Jul	Aug	Sep	Oct	Nov	Dec
Code	1	2	3	4	5	6	7	8	9	O	N	D

Maximum Ratings

Characteristic			Symbol	Value	Units
Drain-Source Voltage			V_{DSS}	60	V
Gate-Source Voltage			V_{GSS}	± 20	V
Continuous Drain Current (Note 4) $V_{GS} = 10V$	Steady State	$T_A = 25^\circ C$	I_D	260	mA
		$T_A = 70^\circ C$		210	
Continuous Drain Current (Note 5) $V_{GS} = 10V$	Steady State	$T_A = 25^\circ C$	I_D	400	mA
		$T_A = 70^\circ C$		310	

Thermal Characteristics

Characteristic	Symbol	Value	Units
Power Dissipation, @ $T_A = 25^\circ C$ (Note 4)	P_D	430	mW
Thermal Resistance, Junction to Ambient @ $T_A = 25^\circ C$ (Note 4)	$R_{\theta JA}$	290	$^\circ C/W$
Power Dissipation, @ $T_A = 25^\circ C$ (Note 5)	P_D	840	mW
Thermal Resistance, Junction to Ambient @ $T_A = 25^\circ C$ (Note 5)	$R_{\theta JSA}$	147	$^\circ C/W$
Operating and Storage Temperature Range	T_J, T_{STG}	-55 to +150	$^\circ C$

Electrical Characteristics @ $T_A = 25^\circ C$ unless otherwise specified

Characteristic	Symbol	Min	Typ	Max	Unit	Test Condition
OFF CHARACTERISTICS (Note 6)						
Drain-Source Breakdown Voltage	BV_{DSS}	60	-	-	V	$V_{GS} = 0V, I_D = 250\mu A$
Zero Gate Voltage Drain Current $T_J = 25^\circ C$	I_{DSS}	-	-	0.1	μA	$V_{DS} = 60V, V_{GS} = 0V$
Gate-Body Leakage	I_{GSS}	-	-	± 10	μA	$V_{GS} = \pm 20V, V_{DS} = 0V$
ON CHARACTERISTICS (Note 6)						
Gate Threshold Voltage	$V_{GS(th)}$	1.2	-	2.0	V	$V_{DS} = V_{GS}, I_D = 250\mu A$
Static Drain-Source On-Resistance	$R_{DS(on)}$	-	2.1	3.0	Ω	$V_{GS} = 10V, I_D = 0.115A$
		-	2.3	4.0		
Forward Transfer Admittance	$ Y_{fs} $	80	320	-	mS	$V_{DS} = 10V, I_D = 0.115A$
Diode Forward Voltage	V_{SD}	-	0.7	1.0	V	$V_{GS} = 0V, I_S = 0.115A$
DYNAMIC CHARACTERISTICS (Note 7)						
Input Capacitance	C_{iss}	-	25	-	pF	$V_{DS} = 25V, V_{GS} = 0V, f = 1.0MHz$
Output Capacitance	C_{oss}	-	4.7	-	pF	
Reverse Transfer Capacitance	C_{rss}	-	2.5	-	pF	
Turn-On Delay Time	$t_{D(on)}$	-	3.27	-	ns	$V_{DD} = 30V, V_{GEN} = 10V, R_{GEN} = 25\Omega, I_D = 0.115A$
Turn-On Rise Time	t_r	-	3.15	-	ns	
Turn-Off Delay Time	$t_{D(off)}$	-	12.025	-	ns	
Turn-Off Fall Time	t_f	-	6.29	-	ns	

- Notes:
4. Device mounted on FR-4 PCB with minimum recommended pad layout, single sided.
 5. Device mounted on 2" x 2" FR-4 PCB with high coverage 2 oz. Copper, single sided.
 6. Short duration pulse test used to minimize self-heating effect.
 7. Guaranteed by design. Not subject to production testing.

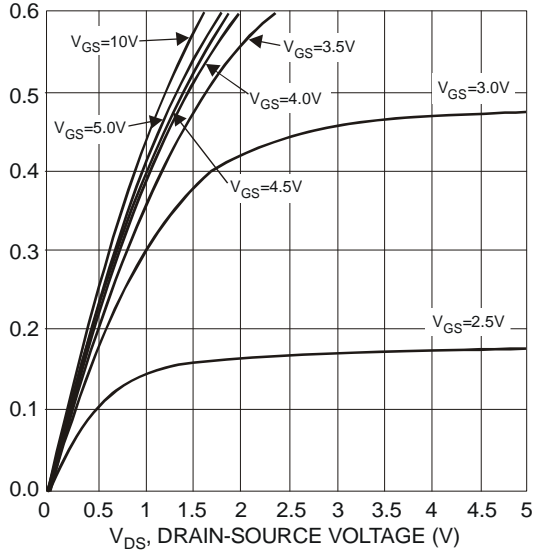

Fig. 1 Typical Output Characteristics

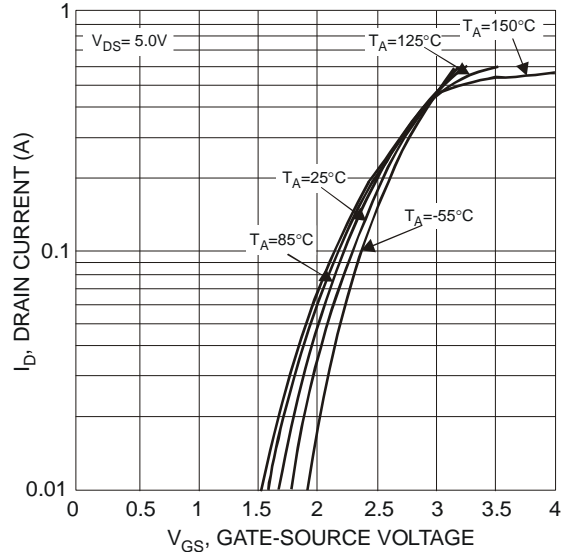

Fig. 2 Typical Transfer Characteristics

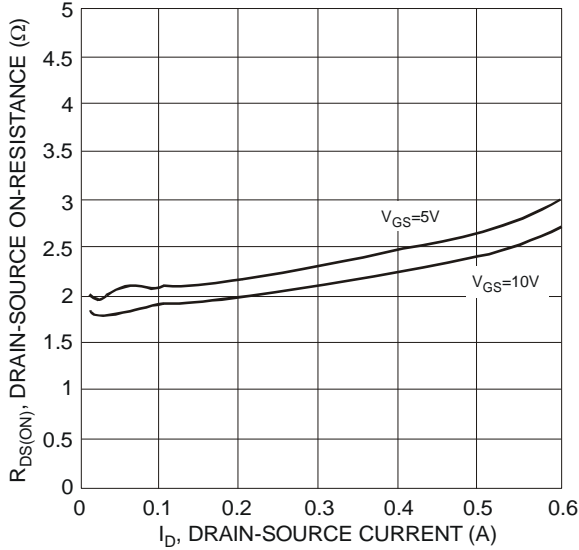

Fig. 3 Typical On-Resistance vs. Drain Current and Gate Charge

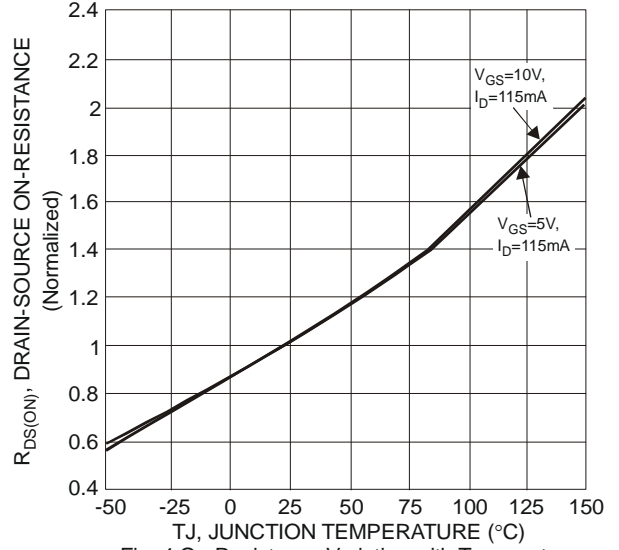

Fig. 4 On-Resistance Variation with Temperature

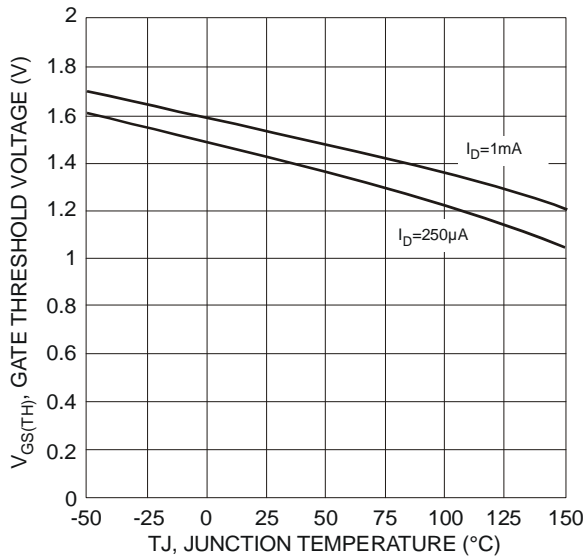

Fig. 5 Gate Threshold Variation vs. Ambient Temperature

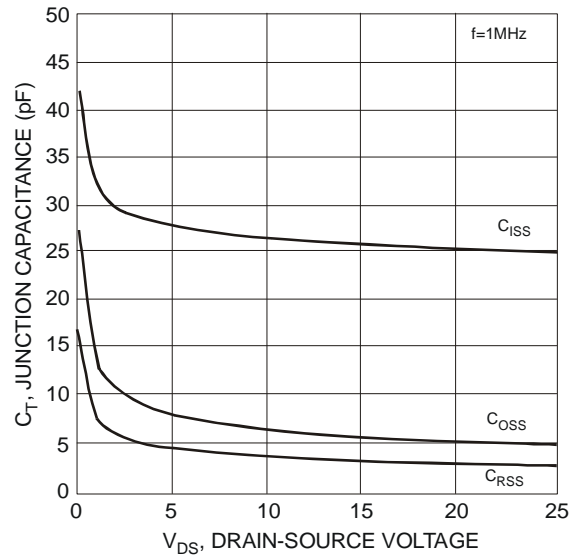
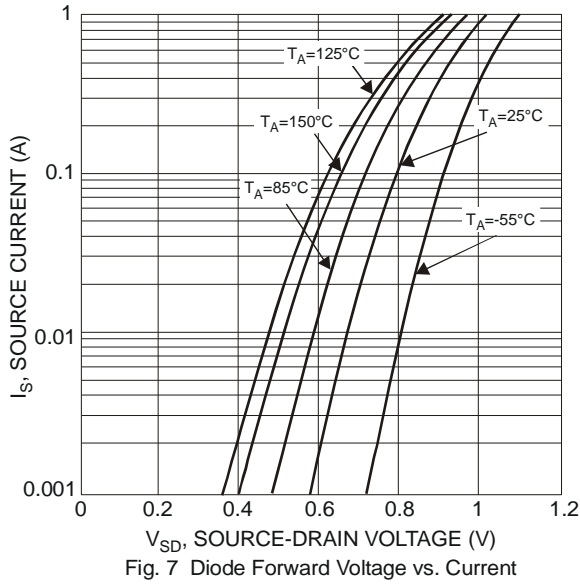
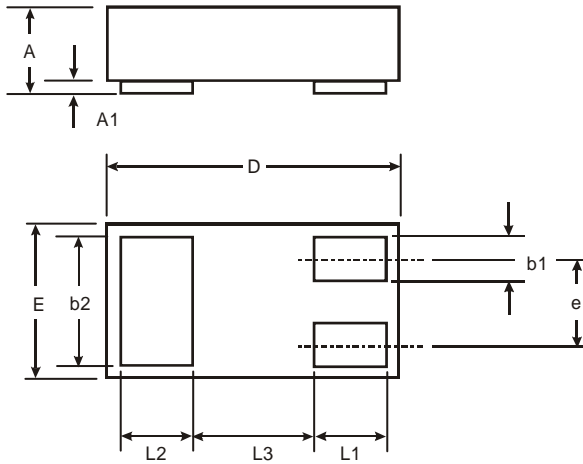

Fig. 6 Typical Junction Capacitance



Package Outline Dimensions



DFN1006			
Dim	Min	Max	Typ
A	0.47	0.53	0.50
A1	0	0.05	0.03
b1	0.10	0.20	0.15
b2	0.45	0.55	0.50
D	0.95	1.075	1.00
E	0.55	0.675	0.60
e	—	—	0.35
L1	0.20	0.30	0.25
L2	0.20	0.30	0.25
L3	—	—	0.40

All Dimensions in mm

Suggested Pad Layout

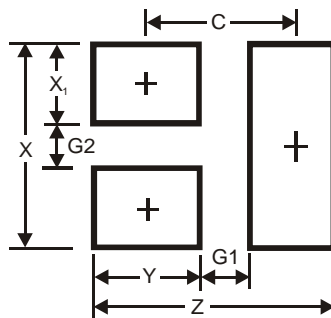

Dimensions	Value (in mm)
Z	1.1
G1	0.3
G2	0.2
X	0.7
X1	0.25
Y	0.4
C	0.7

IMPORTANT NOTICE

DIODES INCORPORATED MAKES NO WARRANTY OF ANY KIND, EXPRESS OR IMPLIED, WITH REGARDS TO THIS DOCUMENT, INCLUDING, BUT NOT LIMITED TO, THE IMPLIED WARRANTIES OF MERCHANTABILITY AND FITNESS FOR A PARTICULAR PURPOSE (AND THEIR EQUIVALENTS UNDER THE LAWS OF ANY JURISDICTION).

Diodes Incorporated and its subsidiaries reserve the right to make modifications, enhancements, improvements, corrections or other changes without further notice to this document and any product described herein. Diodes Incorporated does not assume any liability arising out of the application or use of this document or any product described herein; neither does Diodes Incorporated convey any license under its patent or trademark rights, nor the rights of others. Any Customer or user of this document or products described herein in such applications shall assume all risks of such use and will agree to hold Diodes Incorporated and all the companies whose products are represented on Diodes Incorporated website, harmless against all damages.

Diodes Incorporated does not warrant or accept any liability whatsoever in respect of any products purchased through unauthorized sales channel. Should Customers purchase or use Diodes Incorporated products for any unintended or unauthorized application, Customers shall indemnify and hold Diodes Incorporated and its representatives harmless against all claims, damages, expenses, and attorney fees arising out of, directly or indirectly, any claim of personal injury or death associated with such unintended or unauthorized application.

Products described herein may be covered by one or more United States, international or foreign patents pending. Product names and markings noted herein may also be covered by one or more United States, international or foreign trademarks.

LIFE SUPPORT

Diodes Incorporated products are specifically not authorized for use as critical components in life support devices or systems without the express written approval of the Chief Executive Officer of Diodes Incorporated. As used herein:

A. Life support devices or systems are devices or systems which:

1. are intended to implant into the body, or
2. support or sustain life and whose failure to perform when properly used in accordance with instructions for use provided in the labeling can be reasonably expected to result in significant injury to the user.

B. A critical component is any component in a life support device or system whose failure to perform can be reasonably expected to cause the failure of the life support device or to affect its safety or effectiveness.

Customers represent that they have all necessary expertise in the safety and regulatory ramifications of their life support devices or systems, and acknowledge and agree that they are solely responsible for all legal, regulatory and safety-related requirements concerning their products and any use of Diodes Incorporated products in such safety-critical, life support devices or systems, notwithstanding any devices- or systems-related information or support that may be provided by Diodes Incorporated. Further, Customers must fully indemnify Diodes Incorporated and its representatives against any damages arising out of the use of Diodes Incorporated products in such safety-critical, life support devices or systems.

Copyright © 2011, Diodes Incorporated

www.diodes.com