

# GL79XX Series

## NEGATIVE VOLTAGE REGULATOR

### Description

The GL79XX series of fixed output negative voltage regulators are intended as complements to the popular GL78XX series devices. Available in fixed output voltage options from -5 to -24 Volts, these regulators employ internal current limiting, thermal shutdown, and safe-area compensation-making them remarkably rugged under most operating conditions. With adequate heat-sinking they can deliver output currents in excess of 1.0A.

### Features

- High Line Regulation
- High Load Regulation
- Good Ripple Rejection (70dB)
- Low Temperature Coefficient of Output\* (-1.0mV/°C)
- Wide Range Input Voltage
- Low Input Bias Current
- Low Output Noise
- Output Current in Excess of 1A

### Pin Configuration

(Top View)

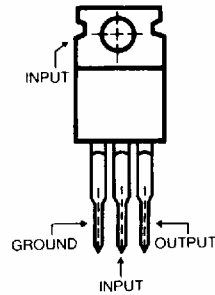

### Type No/Voltage

GL7905	-5.0 Volts
GL7909	-9.0 Volts
GL7912	-12.0 Volts
GL7915	-15.0 Volts
GL7924	-24.0 Volts

### Block Diagram

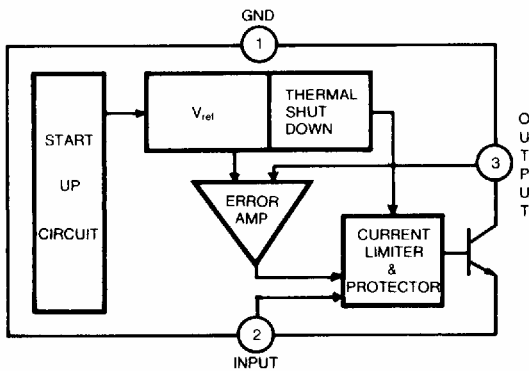

### Maximum Ratings (T<sub>A</sub> = 25°C)

- Input Voltage  
(-5V Through -15V)                      -35V  
(-24V)    -40V
- Output Current                                      2.2A
- Power Dissipation                                Internally Limited
- Operating Junction Temp.                      0°C to +150°C
- Storage Temp.                                      -65°C to +150°C
- Lead Temp. (Soldering, 10S)                      230°C

## GL79XX Series

### GL7905 Electrical Characteristics ( $T_A = 25^\circ\text{C}$ )

PARAMETER	SYMBOL	TEST CONDITIONS	VALUES		UNIT	
			MIN.	MAX.		
Output Voltage (1)	$V_{O1}$	$T_J = 25^\circ\text{C}$ , $V_{in} = -10\text{V}$ , $I_o = 500\text{mA}$	-5.2	-4.8	V	
Output Voltage (2)	$V_{O2}$	$-20\text{V} \leq V_{in} \leq -7\text{V}$ , $5.0\text{mA} \leq I_o \leq 1.0\text{A}$	-5.25	-4.75	V	
Line Regulation	$\Delta V_{O1}$	$T_J = 25^\circ\text{C}$	$-25\text{V} \leq V_{in} \leq -7\text{V}$ , $I_o = 100\text{mA}$		50	mV
	$\Delta V_{O2}$		$-12\text{V} \leq V_{in} \leq -8\text{V}$ , $I_o = 100\text{mA}$		25	mV
	$\Delta V_{O3}$		$-25\text{V} \leq V_{in} \leq -7\text{V}$ , $I_o = 500\text{mA}$		100	mV
	$\Delta V_{O4}$		$-12\text{V} \leq V_{in} \leq -8\text{V}$ , $I_o = 500\text{mA}$		50	mV
Load Regulation	$\Delta V_{O5}$	$T_J = 25^\circ\text{C}$	$5.0\text{mA} \leq I_o \leq 1.5\text{A}$ , $V_{in} = -10\text{V}$		100	mV
	$\Delta V_{O6}$		$250\text{mA} \leq I_o \leq 750\text{mA}$ , $V_{in} = -10\text{V}$		50	mV
Quiescent Current	$I_Q$	$T_J = 25^\circ\text{C}$ , $V_{in} = -10\text{V}$ , $I_o = 500\text{mA}$		2.0	mA	
Quiescent Current Change	$\Delta I_{Q1}$	$-25\text{V} \leq V_{in} \leq -17\text{V}$ , $I_o = 500\text{mA}$		1.3	mA	
	$\Delta I_{Q2}$	$V_{in} = -10\text{V}$ , $5\text{mA} \leq I_o \leq 1.5\text{A}$		0.5	mA	
Output Noise Voltage	$N_o$	$V_{in} = -10\text{V}$ , $I_o = 500\text{mA}$ $10\text{Hz} \leq f \leq 100\text{KHz}$		80	$\mu\text{V}$	
Ripple Rejection	$R_R$	$T_J = 25^\circ\text{C}$ , $V_i = 1\text{V}_{(rms)}$ , $120\text{Hz}$ , $I_o = 20\text{mA}$ , $-18\text{V} \leq V_{in} \leq -8\text{V}$	54		dB	
Input-Output Voltage Differential	$V_d$	$T_J = 25^\circ\text{C}$ , $I_o = 1.0\text{A}$		1.1(TYP)	V	

### GL7909 Electrical Characteristics ( $T_A = 25^\circ\text{C}$ )

PARAMETER	SYMBOL	TEST CONDITIONS	VALUES		UNIT	
			MIN.	MAX.		
Output Voltage (1)	$V_{O1}$	$T_J = 25^\circ\text{C}$ , $V_{in} = -15\text{V}$ , $I_o = 500\text{mA}$	-9.35	-8.65	V	
Output Voltage (2)	$V_{O2}$	$-24\text{V} \leq V_{in} \leq -11.5\text{V}$ , $5.0\text{mA} \leq I_o \leq 1.0\text{A}$	-9.55	-8.55	V	
Line Regulation	$\Delta V_{O1}$	$T_J = 25^\circ\text{C}$	$-26\text{V} \leq V_{in} \leq -11.5\text{V}$ , $I_o = 100\text{mA}$		90	mV
	$\Delta V_{O2}$		$-18\text{V} \leq V_{in} \leq -12\text{V}$ , $I_o = 100\text{mA}$		45	mV
	$\Delta V_{O3}$		$-26\text{V} \leq V_{in} \leq -11.5\text{V}$ , $I_o = 500\text{mA}$		180	mV
	$\Delta V_{O4}$		$-18\text{V} \leq V_{in} \leq -12\text{V}$ , $I_o = 500\text{mA}$		90	mV
Load Regulation	$\Delta V_{O5}$	$T_J = 25^\circ\text{C}$	$5.0\text{mA} \leq I_o \leq 1.5\text{A}$ , $V_{in} = -15\text{V}$		180	mV
	$\Delta V_{O6}$		$250\text{mA} \leq I_o \leq 750\text{mA}$ , $V_{in} = -15\text{V}$		90	mV
Quiescent Current	$I_Q$	$T_J = 25^\circ\text{C}$ , $V_{in} = -15\text{V}$ , $I_o = 500\text{mA}$		3	mA	
Quiescent Current Change	$\Delta I_{Q1}$	$-26\text{V} \leq V_{in} \leq -11.5\text{V}$ , $I_o = 500\text{mA}$		1.0	mA	
	$\Delta I_{Q2}$	$V_{in} = -15\text{V}$ , $5\text{mA} \leq I_o \leq 1.5\text{A}$		0.5	mA	
Output Noise Voltage	$N_o$	$V_{in} = -15\text{V}$ , $I_o = 500\text{mA}$ $10\text{Hz} \leq f \leq 100\text{KHz}$		120	$\mu\text{V}$	
Ripple Rejection	$R_R$	$T_J = 25^\circ\text{C}$ , $V_i = 1\text{V}_{(rms)}$ , $120\text{Hz}$ , $I_o = 20\text{mA}$ , $-22\text{V} \leq V_{in} \leq -12\text{V}$	54		dB	
Input-Output Voltage Differential	$V_d$	$T_J = 25^\circ\text{C}$ , $I_o = 1.0\text{A}$		1.1(TYP)	V	

# GL79XX Series

## GL7912 Electrical Characteristics (T<sub>A</sub> = 25°C)

PARAMETER	SYMBOL	TEST CONDITIONS	VALUES		UNIT	
			MIN.	MAX.		
Output Voltage (1)	V <sub>O1</sub>	T <sub>J</sub> = 25°C, V <sub>in</sub> = -19V, I <sub>o</sub> = 500mA	-12.5	-11.5	V	
Output Voltage (2)	V <sub>O2</sub>	-27V ≤ V <sub>in</sub> ≤ -14.5V, 5.0mA ≤ I <sub>o</sub> ≤ 1.0A	-12.5	-11.4	V	
Line Regulation	ΔV <sub>O1</sub>	T <sub>J</sub> = 25°C		-30V ≤ V <sub>in</sub> ≤ -14.5V, I <sub>o</sub> = 100mA	120	mV
	ΔV <sub>O2</sub>			-22V ≤ V <sub>in</sub> ≤ -16V, I <sub>o</sub> = 100mA	60	mV
	ΔV <sub>O3</sub>			-30V ≤ V <sub>in</sub> ≤ -14.5V, I <sub>o</sub> = 500mA	240	mV
	ΔV <sub>O4</sub>			-22V ≤ V <sub>in</sub> ≤ -16V, I <sub>o</sub> = 500mA	120	mV
Load Regulation	ΔV <sub>O5</sub>	T <sub>J</sub> = 25°C	5.0mA ≤ I <sub>o</sub> ≤ 1.5A, V <sub>in</sub> = -19V	240	mV	
	ΔV <sub>O6</sub>		250mA ≤ I <sub>o</sub> ≤ 750mA, V <sub>in</sub> = -19V	120	mV	
Quiescent Current	I <sub>Q</sub>	T <sub>J</sub> = 25°C, V <sub>in</sub> = -19V, I <sub>o</sub> = 500mA		3	mA	
Quiescent Current Change	ΔI <sub>Q1</sub>	-30V ≤ V <sub>in</sub> ≤ -14.5V, I <sub>o</sub> = 500mA		1.0	mA	
	ΔI <sub>Q2</sub>	V <sub>in</sub> = -19V, 5mA ≤ I <sub>o</sub> ≤ 1.5A		0.5	mA	
Output Noise Voltage	N <sub>o</sub>	V <sub>in</sub> = -19V, I <sub>o</sub> = 500mA 10Hz ≤ f ≤ 100KHz		150	μV	
Ripple Rejection	R <sub>R</sub>	T <sub>J</sub> = 25°C, V <sub>r</sub> = 1V <sub>(rms)</sub> , 120Hz, I <sub>o</sub> = 20mA, -25V ≤ V <sub>in</sub> ≤ -15V	54		dB	
Input-Output Voltage Differential	V <sub>d</sub>	T <sub>J</sub> = 25°C, I <sub>o</sub> = 1.0A		1.1(TYP)	V	

## GL7915 Electrical Characteristics (T<sub>A</sub> = 25°C)

PARAMETER	SYMBOL	TEST CONDITIONS	VALUES		UNIT	
			MIN.	MAX.		
Output Voltage (1)	V <sub>O1</sub>	T <sub>J</sub> = 25°C, V <sub>in</sub> = -23V, I <sub>o</sub> = 500mA	-15.6	-14.4	V	
Output Voltage (2)	V <sub>O2</sub>	-30V ≤ V <sub>in</sub> ≤ -17.5V, 5.0mA ≤ I <sub>o</sub> ≤ 1.0A	-15.75	-14.25	V	
Line Regulation	ΔV <sub>O1</sub>	T <sub>J</sub> = 25°C		-30V ≤ V <sub>in</sub> ≤ -17.5V, I <sub>o</sub> = 100mA	150	mV
	ΔV <sub>O2</sub>			-26V ≤ V <sub>in</sub> ≤ -20V, I <sub>o</sub> = 100mA	75	mV
	ΔV <sub>O3</sub>			-30V ≤ V <sub>in</sub> ≤ -17.5V, I <sub>o</sub> = 500mA	300	mV
	ΔV <sub>O4</sub>			-26V ≤ V <sub>in</sub> ≤ -20V, I <sub>o</sub> = 500mA	150	mV
Load Regulation	ΔV <sub>O5</sub>	T <sub>J</sub> = 25°C	5.0mA ≤ I <sub>o</sub> ≤ 1.5A, V <sub>in</sub> = -23V	300	mV	
	ΔV <sub>O6</sub>		250mA ≤ I <sub>o</sub> ≤ 750mA, V <sub>in</sub> = -23V	150	mV	
Quiescent Current	I <sub>Q</sub>	T <sub>J</sub> = 25°C, V <sub>in</sub> = -23V, I <sub>o</sub> = 500mA		3	mA	
Quiescent Current Change	ΔI <sub>Q1</sub>	-30V ≤ V <sub>in</sub> ≤ -17.5V, I <sub>o</sub> = 500mA		1.0	mA	
	ΔI <sub>Q2</sub>	V <sub>in</sub> = -23V, 5mA ≤ I <sub>o</sub> ≤ 1.5A		0.5	mA	
Output Noise Voltage	N <sub>o</sub>	V <sub>in</sub> = -23V, I <sub>o</sub> = 500mA 10Hz ≤ f ≤ 100KHz		180	μV	
Ripple Rejection	R <sub>R</sub>	T <sub>J</sub> = 25°C, V <sub>r</sub> = 1V <sub>(rms)</sub> , 120Hz, I <sub>o</sub> = 20mA, -28.5V ≤ V <sub>in</sub> ≤ -18.5V	54		dB	
Input-Output Voltage Differential	V <sub>d</sub>	T <sub>J</sub> = 25°C, I <sub>o</sub> = 1.0A		1.1(TYP)	V	

# GL79XX Series

## GL7924 Electrical Characteristics ( $T_A = 25^\circ\text{C}$ )

$C_{in} = 2\mu\text{F}$ ,  $C_{out} = 1\mu\text{F}$

PARAMETER	SYMBOL	TEST CONDITIONS	VALUES		UNIT	
			MIN	MAX.		
Output Voltage (1)	$V_{O1}$	$T_J = 25^\circ\text{C}$ , $V_{in} = -33\text{V}$ , $I_o = 500\text{mA}$	-25	-23	V	
Output Voltage (2)	$V_{O2}$	$-38\text{V} \leq V_{in} \leq -27\text{V}$ , $5.0\text{mA} \leq I_o \leq 1.0\text{A}$	-25.2	-22.8	V	
Line Regulation	$\Delta V_{O1}$	$T_J = 25^\circ\text{C}$	$-38\text{V} \leq V_{in} \leq -27\text{V}$ , $I_o = 100\text{mA}$		240	mV
	$\Delta V_{O2}$		$-36\text{V} \leq V_{in} \leq -30\text{V}$ , $I_o = 100\text{mA}$		120	mV
	$\Delta V_{O3}$		$-38\text{V} \leq V_{in} \leq -27\text{V}$ , $I_o = 500\text{mA}$		480	mV
	$\Delta V_{O4}$		$-36\text{V} \leq V_{in} \leq -30\text{V}$ , $I_o = 500\text{mA}$		240	mV
Load Regulation	$\Delta V_{O5}$	$T_J = 25^\circ\text{C}$	$5.0\text{mA} \leq I_o \leq 1.5\text{A}$ , $V_{in} = -33\text{V}$		480	mV
	$\Delta V_{O6}$		$250\text{mA} \leq I_o \leq 750\text{mA}$ , $V_{in} = -33\text{V}$		240	mV
Quiescent Current	$I_Q$	$T_J = 25^\circ\text{C}$ , $V_{in} = -33\text{V}$ , $I_o = 500\text{mA}$			3	mA
Quiescent Current Change	$\Delta I_{Q1}$	$-38\text{V} \leq V_{in} \leq -27\text{V}$ , $I_o = 500\text{mA}$			1.0	mA
	$\Delta I_{Q2}$	$V_{in} = -33\text{V}$ , $5\text{mA} \leq I_o \leq 1.5\text{A}$			0.5	mA
Output Noise Voltage	$N_o$	$V_{in} = -33\text{V}$ , $I_o = 500\text{mA}$ $10\text{Hz} \leq f \leq 100\text{KHz}$			270	$\mu\text{V}$
Ripple Rejection	$R_R$	$T_J = 25^\circ\text{C}$ , $V_i = 1V_{(rms)}$ , $120\text{Hz}$ , $I_o = 20\text{mA}$ , $-38\text{V} \leq V_{in} \leq -28\text{V}$	54			dB
Input-Output Voltage Differential	$V_d$	$T_J = 25^\circ\text{C}$ , $I_o = 1.0\text{A}$			1.1 (TYP)	V

### \*GL79XX Series Test Circuit (AC & DC)

1  $V_{O1}$ ,  $V_{O2}$ ,  $\Delta V_o$ ,  $I_Q$ ,  $\Delta I_Q$ ,  $V_d$

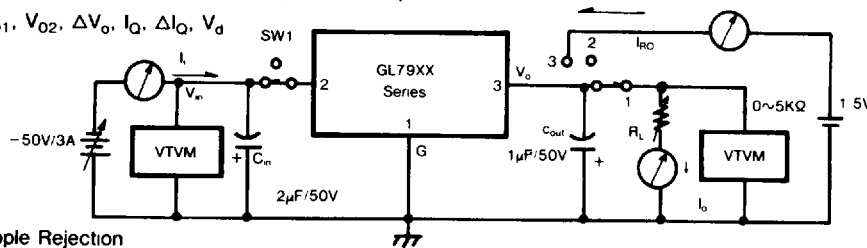

2. Ripple Rejection

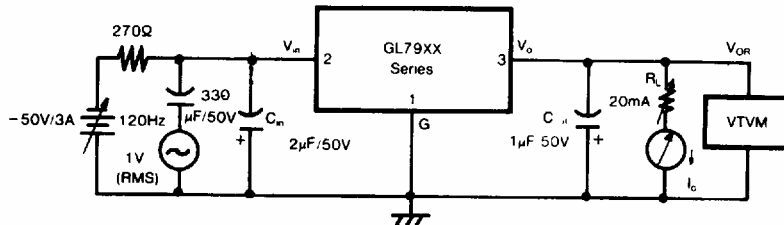

3. Output Noise Voltage

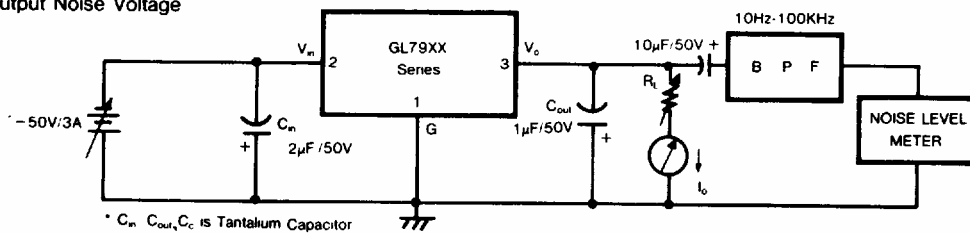

\*  $C_{in}$ ,  $C_{out}$ ,  $C_c$  is Tantalum Capacitor

## TYPICAL CHARACTERISTICS ( $T_A = +25^\circ\text{C}$ unless otherwise noted.)

FIGURE 1 – AVERAGE CASE POWER DISSIPATION AS A FUNCTION OF AMBIENT TEMPERATURE (TO-220)

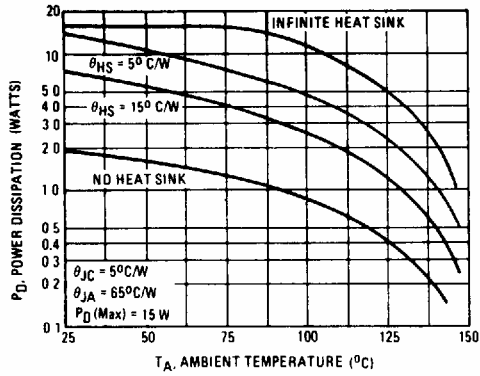

FIGURE 2 – PEAK OUTPUT CURRENT AS A FUNCTION OF INPUT-OUTPUT DIFFERENTIAL VOLTAGE

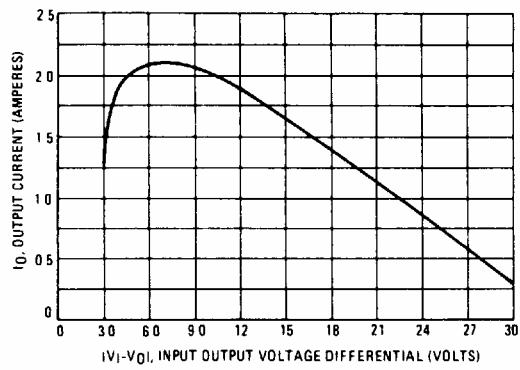

FIGURE 3 – RIPPLE REJECTION AS A FUNCTION OF FREQUENCY

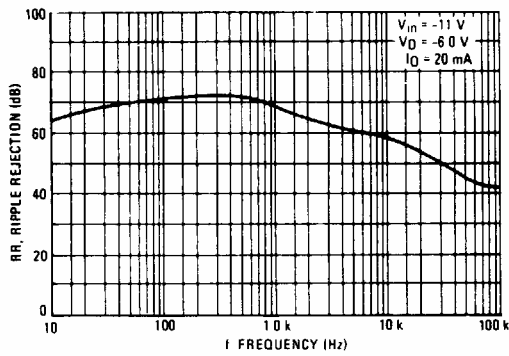

FIGURE 4 – RIPPLE REJECTION AS A FUNCTION OF OUTPUT VOLTAGES

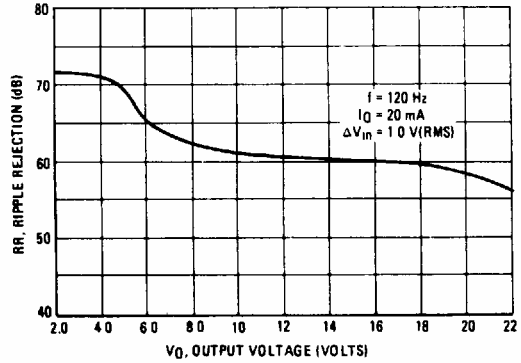

FIGURE 5 – OUTPUT VOLTAGE AS A FUNCTION OF JUNCTION TEMPERATURE

