

**EnFilm™ - rechargeable solid state lithium thin film battery**

Datasheet – production data

**Features**

- All solid-state
- Ultra thin
- Fast recharge
- Low capacity loss
- Long cycle life
- RoHS compliant
- UL file number: MH47669

**Complies with the following standards**

- IEC 62133
- UN Manual of Tests and Criteria, Part III, subsection 38.3
- ISO7816 / IEC10373 (mechanical / flexibility smartcard standards)

**Applications**

Device is intended to be used in a wide range of applications including:

- Internet of things
- Sensors and networks
- Smart card
- RF ID tags
- Energy storage for energy harvesting devices
- Non implantable medical applications
- Backup power
- Wearable applications

**Description**

The EFL700A39 is a thin film rechargeable lithium battery. The battery has a  $\text{LiCoO}_2$  cathode, LiPON ceramic electrolyte and a lithium anode.

**Table 1. Device summary**

Symbol	Value
Capacity	0.7 mAh
$V_{\text{nominal}}$	3.9 V
$V_{\text{op}}$	3.0 to 4.2 V
$R_{\text{int}}$	100 ohm
$I_{\text{p}}$	10 mA
Dimension	25.7 x 25.7 mm
Thickness	220 $\mu\text{m}$

TM: EnFilm is a trademark of STMicroelectronics

# 1 Characteristics

**Table 2. Absolute ratings**

Symbol	Parameter	Value	Unit
$V_{op}$	Operating voltage	3.0 – 4.2	V
$I_c$	Maximum continuous discharge current	5	mA
$I_p$	Maximum pulsed discharge current <sup>(1)</sup> at 30 °C	10	mA
$T_{stg}$	Storage temperature range	- 20 to 60	°C
$T_{op}$	Operating temperature range <sup>(2)</sup>	- 20 to 60	°C
$C_{lfe}$	Cycle life (to minimum of 80% of initial capacity) <sup>(3)</sup>	4000	cycle

1. Pulsing conditions: 100 ms on, 0.9 s off, cut off voltage during pulse = 2 V for higher pulses current contact ST representative
2. 1/30 C discharge at -20 °C: operating at 60 °C reduces the cycle life
3. 1C discharge rate: cycling between SoC = 75% to SoC = 0% (SoC = state of charge)

**Table 3. Electrical characteristics**

Symbol	Parameter	Test conditions	Min	Typ	Max	Unit
C	Nominal capacity (minimum)	T = 30 °C Discharge @ 1 mA Cut-off voltage = 3.0 V	0.7	-	-	mAh
$R_{int}$	Internal resistance	T = 30 °C	-	100	120	ohm
$C_t$	Charge time to 80% of full capacity	Constant voltage = 4.2 V	-	-	20	mn
$S_{Disch}$	Self discharge	Charge loss (recoverable)	Room temperature <sup>(1)</sup> SoC = 50%	-	3	%/year
		Capacity loss (Non-recoverable)		-	20	% over 10 years

1. For other operating conditions contact ST representative

Figure 1. Typical discharge curve

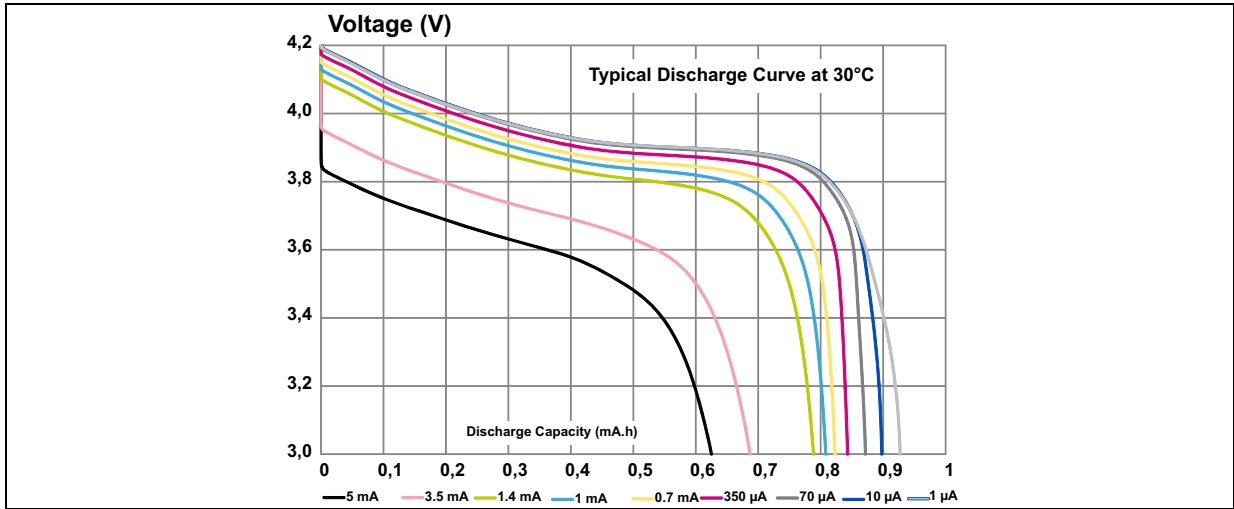

Figure 2. Typical charge curve

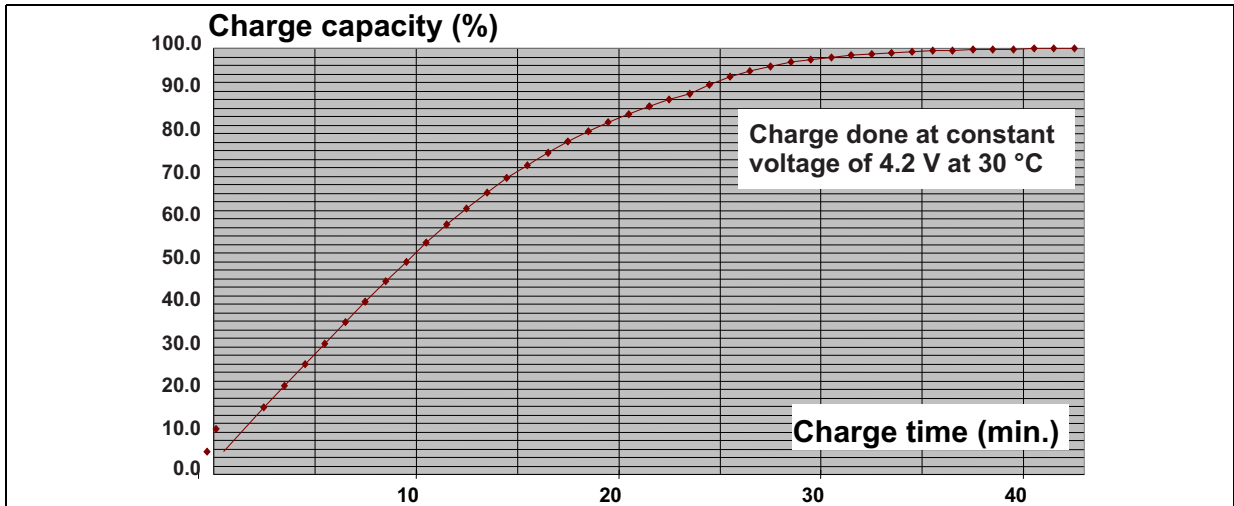
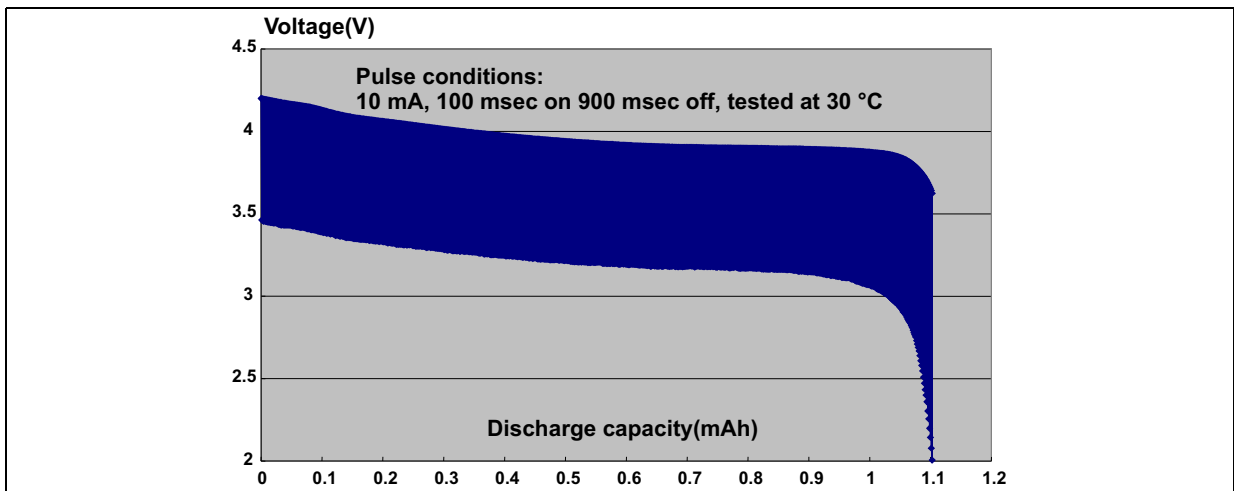

Figure 3. Typical pulsed discharge curve



## 2 Application information

This product is not authorized for use in (i) implantable medical devices (devices placed under the skin (devices such as hearing aids are not considered implantable medical devices)), (ii) US government specific (custom) applications or (iii) wafer test devices ("Prohibited Applications"). ST disclaims any liability, including any intellectual property infringement or misappropriation claims, resulting from the use of the product in prohibited applications. Any such use shall be at customer's sole risk and the customer shall defend, indemnify and hold harmless ST from any liability, damage, costs or expense (including attorney fees) resulting from such use. Furthermore, ST shall stop selling the product for use in the Prohibited Applications if customer does not cease using the product in the Prohibited Applications within 15 days of notice until such time as customer has taken precautions reasonably satisfactory to ST to prevent such prohibited use. Customer shall be responsible to ST for any finished goods or work in process in such instance similar to any order cancellation.

## 3 Recommended charge and discharge processes

### 3.1 Charge

Battery can be charged from a 4.2 V  $\pm$ 0.05 V constant voltage source with or without current limit. More than 90% of the total capacity is recharged when the charge current falls below 0.1 mA.

### 3.2 Discharge

When discharging under constant current or constant load, the cut-off voltage should be no less than 3.0 V. Cut-off voltage can be lowered to 2.0 V for pulsed discharge.

### 3.3 Design recommendations:

Refer to STMicroelectronics application note:

AN4085:Design considerations of the EFL700A39.

## 4 Package information

In order to meet environmental requirements, ST offers these devices in different grades of ECOPACK<sup>®</sup> packages, depending on their level of environmental compliance. ECOPACK<sup>®</sup> specifications, grade definitions and product status are available at: [www.st.com](http://www.st.com). ECOPACK<sup>®</sup> is an ST trademark.

Figure 4. Package dimension definitions

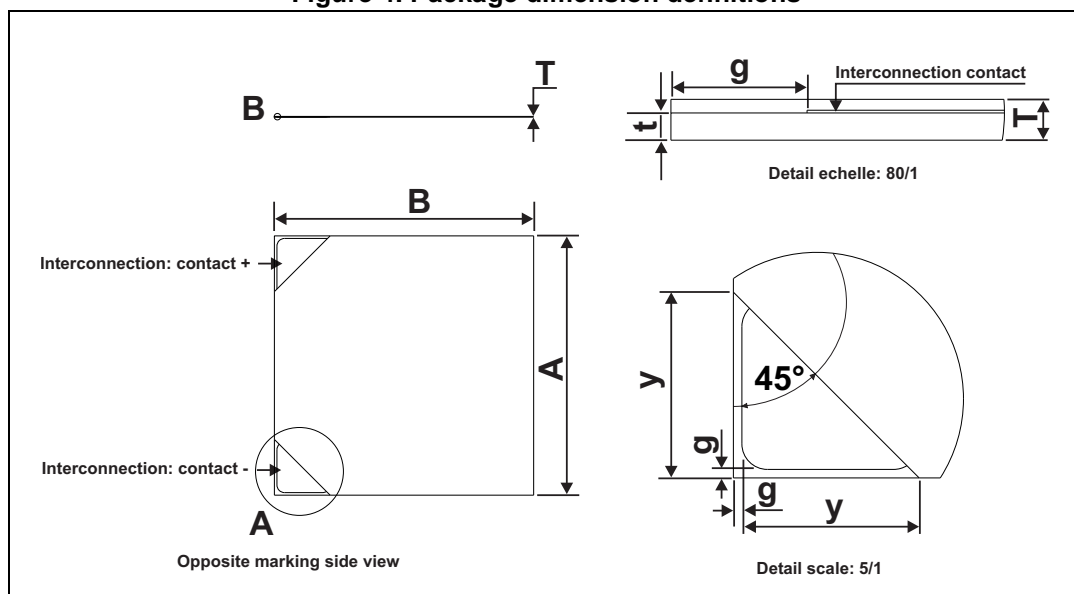

Table 4. Package dimension values

Ref	Dimensions					
	Millimeters			Inches		
	Min.	Typ.	Max.	Min.	Typ.	Max.
A	25.2	25.7	26.05	0.992	1.012	1.026
B	25.2	25.7	26.05	0.992	1.012	1.026
T		0.20	0.22		0.008	0.009
t		0.07			0.003	
Y	5.3		5.9	0.209		0.232
g		0.3			0.012	

Figure 5. Footprint

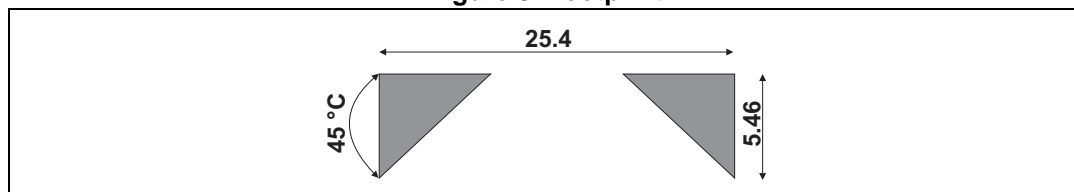

Figure 6. Tray dimensions

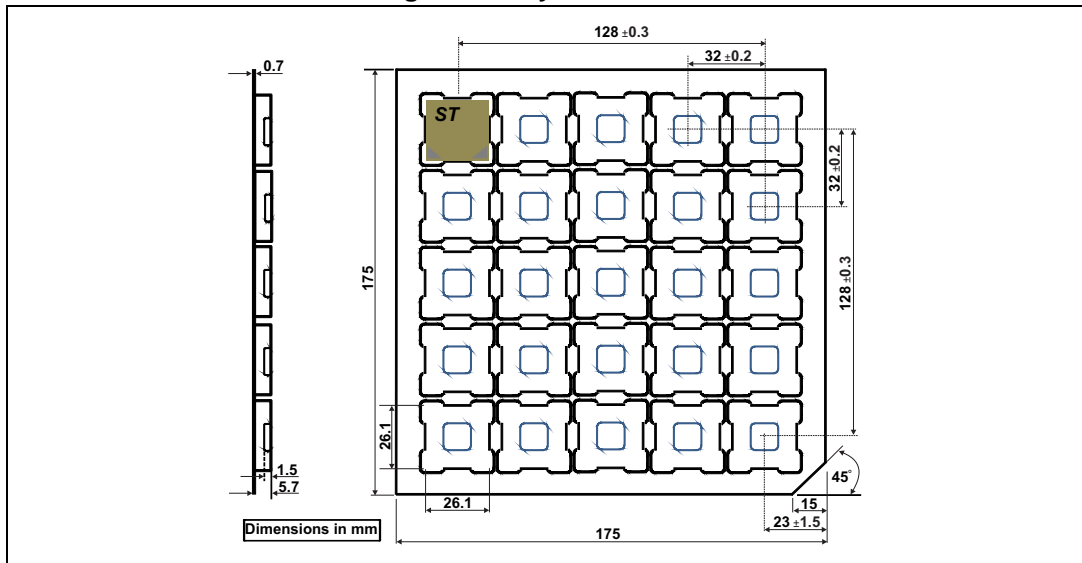
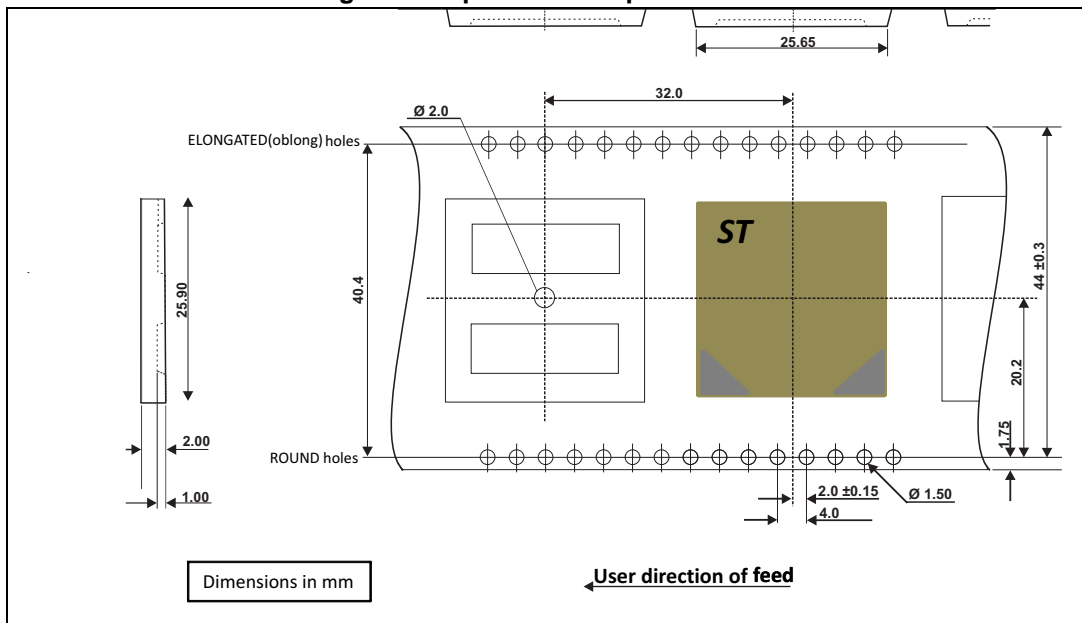

Figure 7. Tape and reel specification



## 5 Recommendations for the assembly on PCB

Refer to the STMicroelectronics Application note:

AN4046: “EnFilm™ micro battery EFL700A39, recommendations for manual assembly on PCB”.

AN4351: “EnFilm™ micro battery EFL700A39, automatic or semi-automatic mounting on PCB”.

## 6 Ordering information

Figure 8. Ordering information scheme

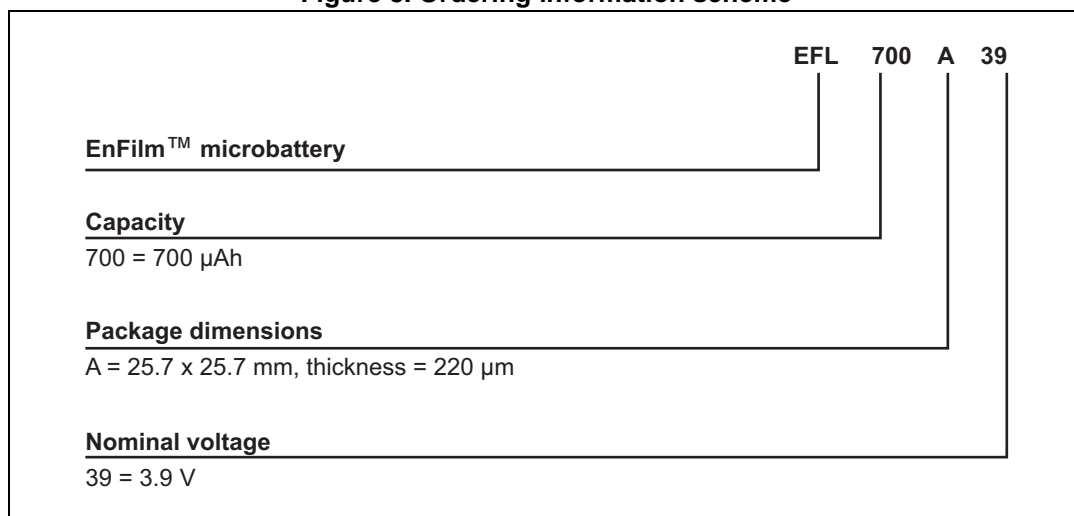

Table 5. Ordering information

Order code	Marking	Weight	Base qty	Delivery mode
EFL700A39	EFL700A39	0.2 g	25	Tray
EFL700A39-RL	EFL700A39	0.2 g	100	Tape and reel

## 7 Revision history

Table 6. Document revision history

Date	Revision	Changes
08-Apr-2010	1	Initial release.
23-Apr-2012	2	Insert AN4046 reference for recommendations for the soldering process and update <a href="#">Figure 4</a> .
27-Sep-2013	3	Updated <a href="#">Figure 4</a> and <a href="#">Chapter 5</a> .
05-Nov-2013	4	Updated <a href="#">Figure 1</a> and <a href="#">Features</a>
02-Jun-2014	5	Updated <a href="#">Features</a> , <a href="#">Applications</a> , <a href="#">Table 1</a> , <a href="#">Table 2</a> , <a href="#">Table 3</a> , <a href="#">Table 4</a> , <a href="#">Table 5</a> , <a href="#">Figure 4</a> and <a href="#">Figure 8</a> . Added <a href="#">Figure 5</a> , <a href="#">Figure 6</a> and <a href="#">Figure 7</a> . Added <a href="#">Chapter 3.3</a> .

**Please Read Carefully:**

Information in this document is provided solely in connection with ST products. STMicroelectronics NV and its subsidiaries ("ST") reserve the right to make changes, corrections, modifications or improvements, to this document, and the products and services described herein at any time, without notice.

All ST products are sold pursuant to ST's terms and conditions of sale.

Purchasers are solely responsible for the choice, selection and use of the ST products and services described herein, and ST assumes no liability whatsoever relating to the choice, selection or use of the ST products and services described herein.

No license, express or implied, by estoppel or otherwise, to any intellectual property rights is granted under this document. If any part of this document refers to any third party products or services it shall not be deemed a license grant by ST for the use of such third party products or services, or any intellectual property contained therein or considered as a warranty covering the use in any manner whatsoever of such third party products or services or any intellectual property contained therein.

**UNLESS OTHERWISE SET FORTH IN ST'S TERMS AND CONDITIONS OF SALE ST DISCLAIMS ANY EXPRESS OR IMPLIED WARRANTY WITH RESPECT TO THE USE AND/OR SALE OF ST PRODUCTS INCLUDING WITHOUT LIMITATION IMPLIED WARRANTIES OF MERCHANTABILITY, FITNESS FOR A PARTICULAR PURPOSE (AND THEIR EQUIVALENTS UNDER THE LAWS OF ANY JURISDICTION), OR INFRINGEMENT OF ANY PATENT, COPYRIGHT OR OTHER INTELLECTUAL PROPERTY RIGHT.**

**ST PRODUCTS ARE NOT DESIGNED OR AUTHORIZED FOR USE IN: (A) SAFETY CRITICAL APPLICATIONS SUCH AS LIFE SUPPORTING, ACTIVE IMPLANTED DEVICES OR SYSTEMS WITH PRODUCT FUNCTIONAL SAFETY REQUIREMENTS; (B) AERONAUTIC APPLICATIONS; (C) AUTOMOTIVE APPLICATIONS OR ENVIRONMENTS, AND/OR (D) AEROSPACE APPLICATIONS OR ENVIRONMENTS. WHERE ST PRODUCTS ARE NOT DESIGNED FOR SUCH USE, THE PURCHASER SHALL USE PRODUCTS AT PURCHASER'S SOLE RISK, EVEN IF ST HAS BEEN INFORMED IN WRITING OF SUCH USAGE, UNLESS A PRODUCT IS EXPRESSLY DESIGNATED BY ST AS BEING INTENDED FOR "AUTOMOTIVE, AUTOMOTIVE SAFETY OR MEDICAL" INDUSTRY DOMAINS ACCORDING TO ST PRODUCT DESIGN SPECIFICATIONS. PRODUCTS FORMALLY ESCC, QML OR JAN QUALIFIED ARE DEEMED SUITABLE FOR USE IN AEROSPACE BY THE CORRESPONDING GOVERNMENTAL AGENCY.**

Resale of ST products with provisions different from the statements and/or technical features set forth in this document shall immediately void any warranty granted by ST for the ST product or service described herein and shall not create or extend in any manner whatsoever, any liability of ST.

ST and the ST logo are trademarks or registered trademarks of ST in various countries.

Information in this document supersedes and replaces all information previously supplied.

The ST logo is a registered trademark of STMicroelectronics. All other names are the property of their respective owners.

© 2014 STMicroelectronics - All rights reserved

STMicroelectronics group of companies

Australia - Belgium - Brazil - Canada - China - Czech Republic - Finland - France - Germany - Hong Kong - India - Israel - Italy - Japan - Malaysia - Malta - Morocco - Philippines - Singapore - Spain - Sweden - Switzerland - United Kingdom - United States of America

[www.st.com](http://www.st.com)