

## 6-line low capacitance IPAD™ for micro-SD card with EMI filtering and ESD protection

Datasheet – production data

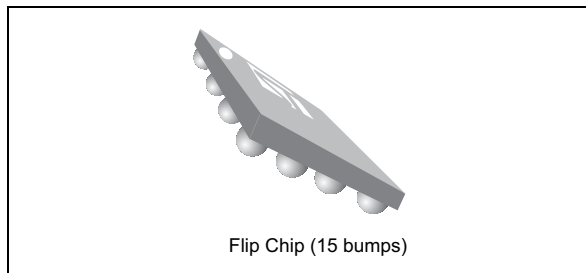

**Figure 1. Pin configuration (bump side)**

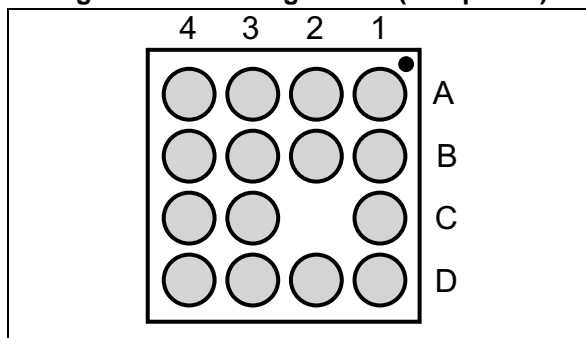

### Features

- Very low line capacitance to compensate long PCB tracks (4.5 pF typ.)
- 208 MHz clock frequency compliant with SD3.0 UHS-1 SDR 104 standard
- High ESD robustness: up to  $\pm 12$  kV contact
- Lead-free package in 400  $\mu\text{m}$  pitch
- Package thickness: 500  $\mu\text{m}$  typ.
- Very low PCB space consumption
- High reliability offer by the monolithic integration

### Complies with the following standards:

- IEC 61000-4-2 level 4
  - $\pm 15$  kV (air discharge)
  - $\pm 8$  kV (contact discharge)

### Application

Where ESD protection for sensitive equipment is required:

- Smartphones and Tablets
- Camera, Printers, Laptops and desktops

### Description

The EMIF06-HSD04F3 chip is a highly integrated device designed to protect the application against ESD event during the insertion of the micro-SD card.

The EMIF06-HSD04F3 must be placed close to the micro-SD card connector for efficient ESD protection.

**TM:** IPAD is a trademark of STMicroelectronics

# 1 Characteristics

**Table 1. Absolute maximum ratings ( $T_{amb} = 25\text{ }^{\circ}\text{C}$ )**

Symbol	Parameter	Value	Unit
$V_{PP}$	ESD discharge IEC 61000-4-2, level 4 (on pins $V_{cc}$ , SDclk, SDcmd, SDdat0, SDdat1, SDdat2, SDdat3 Air discharge	15	kV
	Contact discharge, external pins	12	
	ESD discharge IEC 61000-4-2, level 1 (on pins clk, dat0, dat1, dat2, dat3, cmd)	15	
	Air discharge	10	
	Contact discharge, internal pins		
$T_j$	Maximum junction temperature	125	$^{\circ}\text{C}$
$T_{op}$	Operating temperature range	- 40 to + 85	$^{\circ}\text{C}$
$T_{stg}$	Storage temperature range	- 55 to + 150	$^{\circ}\text{C}$

**Figure 2. EMIF06-HSD04F3 Schematic**

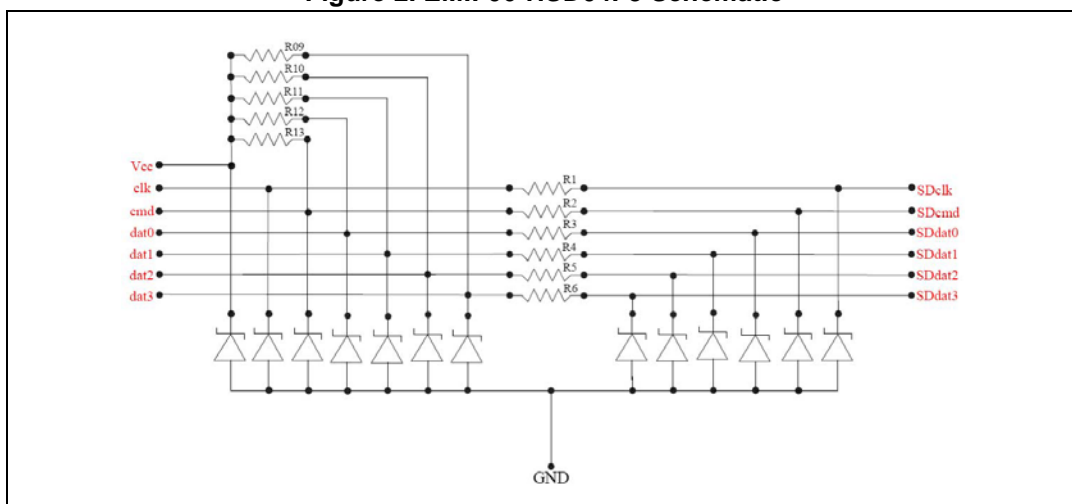

**Table 2. Pin configuration**

Pin	Signal	Pin	Signal
A1	dat0	C1	Cmd
A2	dat1		
A3	SDdat1	C3	GND
A4	SDdat0	C4	SDcmd
B1	clk	D1	dat3
B2	$V_{cc}$	D2	dat2
B3	GND	D3	SDdat2
B4	SDclk	D4	SDdat3

Table 3. Electrical characteristics (values,  $T_{amb} = 25\text{ }^{\circ}\text{C}$ )

Symbol	Parameter	Test conditions	Min.	Typ.	Max.	Unit
$V_{BR}$	Breakdown voltage	$I_R = 1\text{ mA}$	5		9	V
$I_{RM}$	Leakage current at $V_{RM}$	$V_{RM} = 3\text{ V per line}$			100	nA
$C_{line}$	Data line capacitance	$V_{BIAS} = 0\text{ V}, F = 10\text{ MHz}, V_{OSC} = 30\text{ mV}$			4.5	pF
R1, R2, R3, R4, R5, R6	Serial resistance	Tolerance $\pm 23\%$		1		$\Omega$
R9, R10, R11, R12	Pull-up resistance	Tolerance $\pm 20\%$	40	50	60	k $\Omega$
R13	Pull-up resistance on cmd	Tolerance $\pm 20\%$	12	15	18	k $\Omega$

Figure 3. Electrical characteristics (definitions)

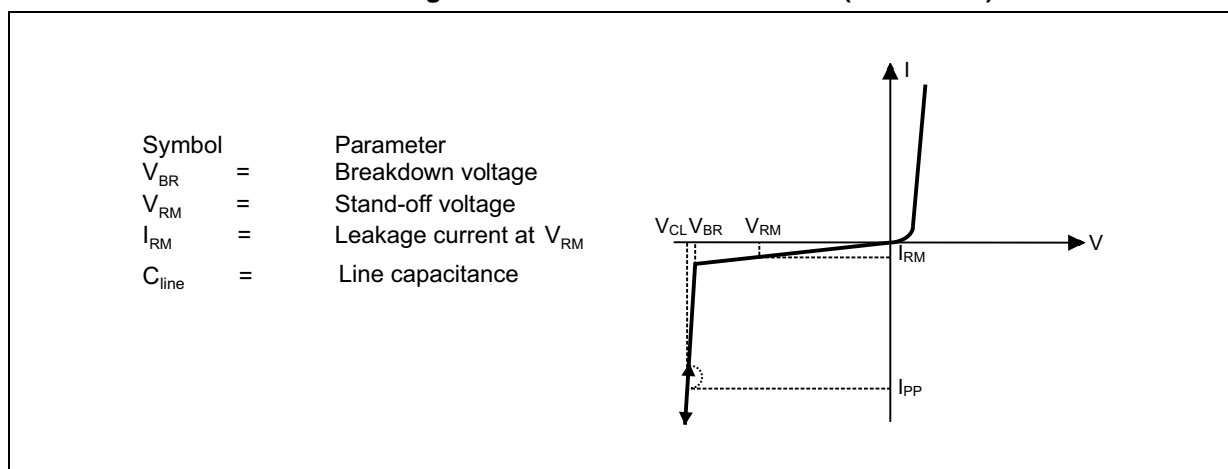

Figure 4. Attenuation versus frequency

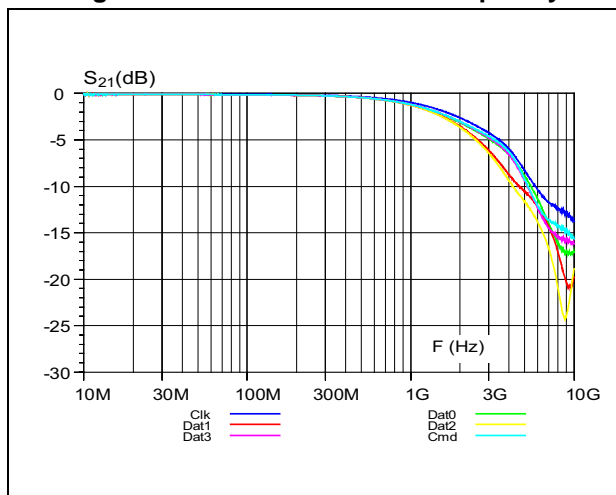

Figure 5. Analog crosstalk versus frequency

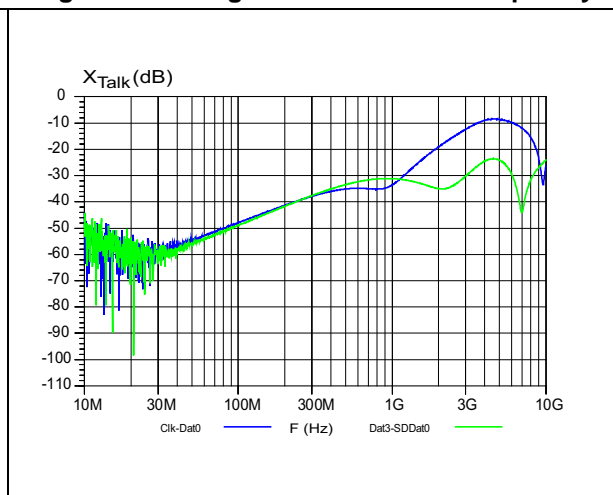

Figure 6. ESD response to IEC 61000-4-2 (+8 kV contact discharge)

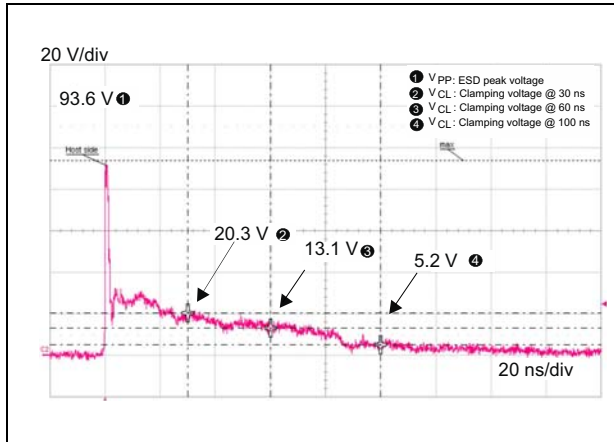

Figure 7. ESD response to IEC 61000-4-2 (-8 kV contact discharge)

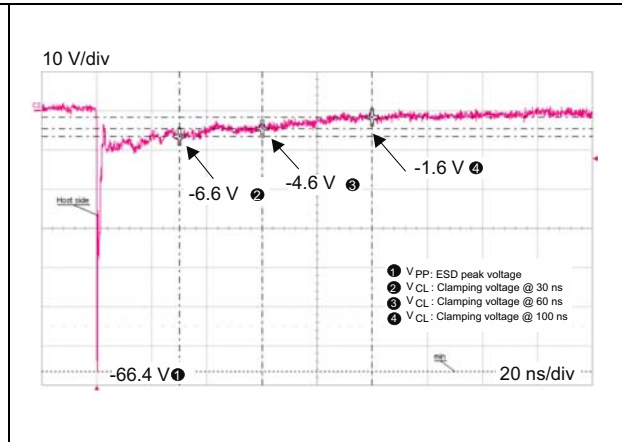

Figure 8. Digital crosstalk dat0 versus clk line ( $V_{CC} = 3.9\text{ V}$ ,  $R_{load} = 1\text{ M}\Omega$ )

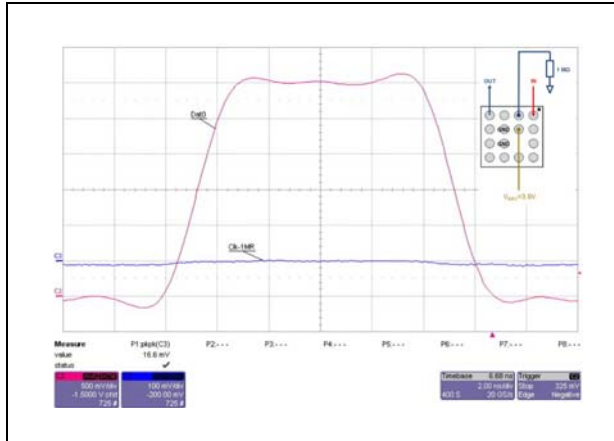

Figure 9. Line capacitance versus frequency

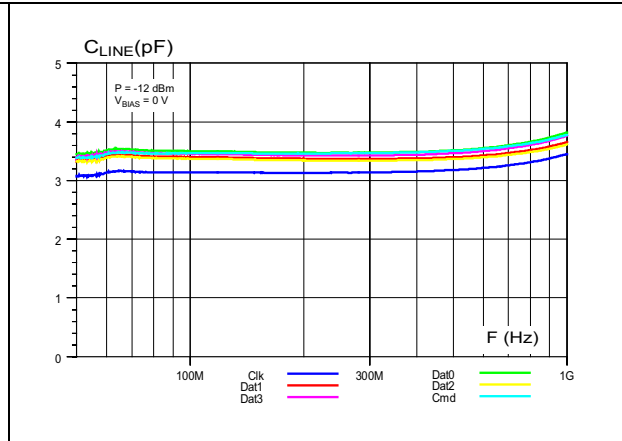
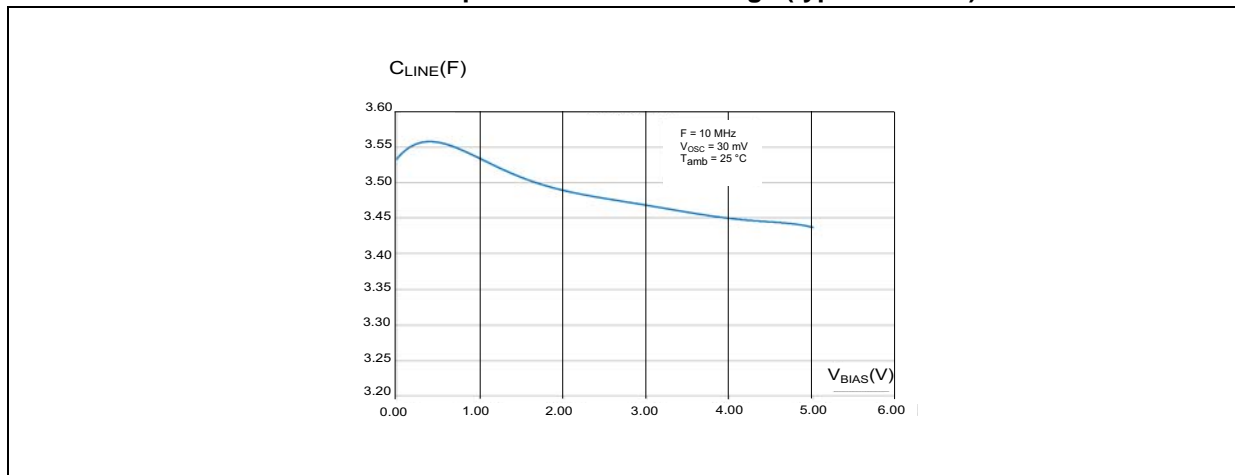

Table 4. Line capacitance versus voltage (typical values)



## 2 Package information

- Epoxy meets UL94, V0
- Lead-free package

In order to meet environmental requirements, ST offers these devices in different grades of ECOPACK® packages, depending on their level of environmental compliance. ECOPACK® specifications, grade definitions and product status are available at: [www.st.com](http://www.st.com). ECOPACK® is an ST trademark.

Figure 10. Flip-Chip package dimensions

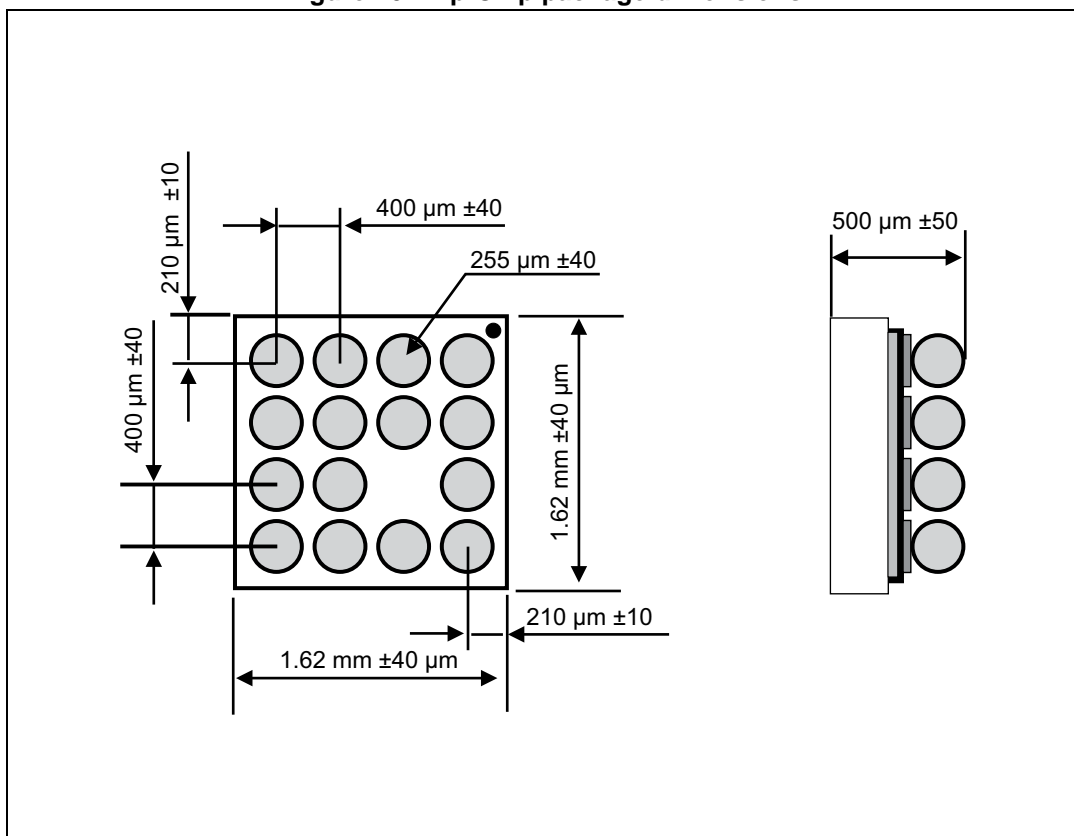

Figure 11. Footprint recommendations

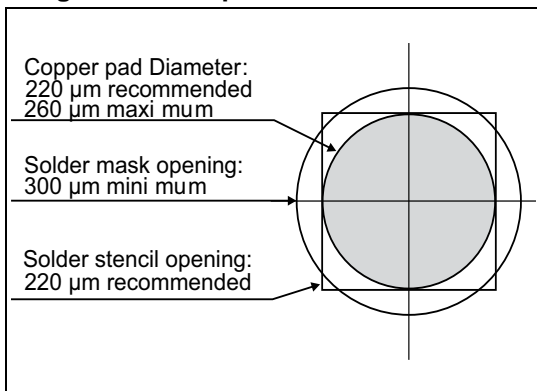

Figure 12. Marking

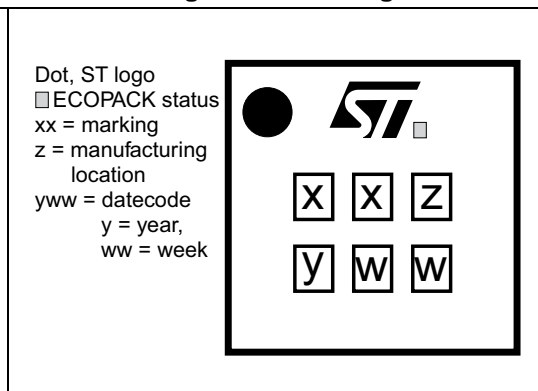
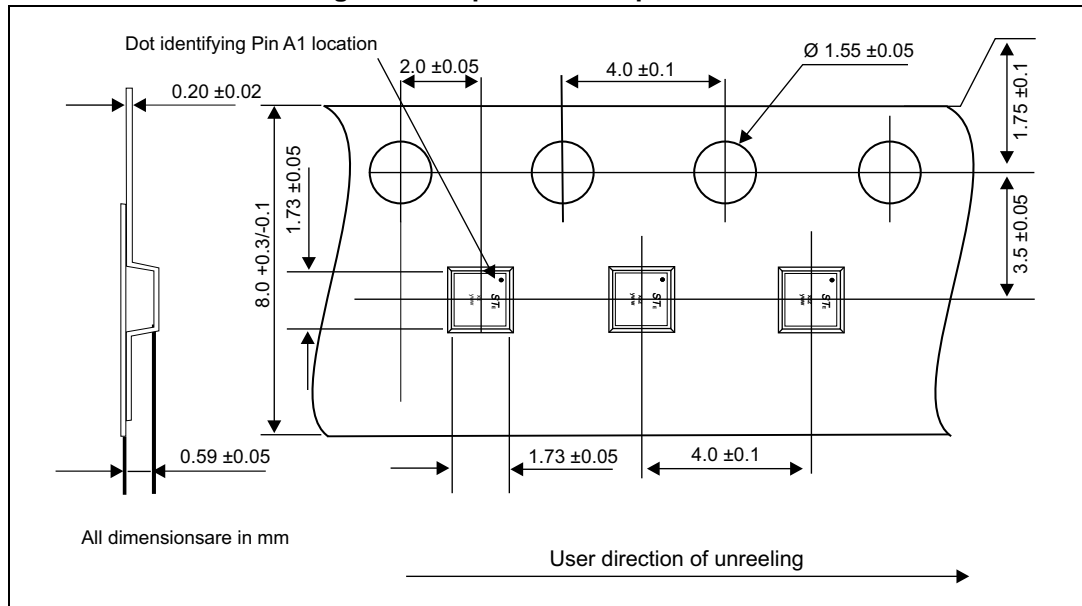

Figure 13. Tape and reel specification



Note: More information is available in the application notes:  
 AN2348, "IPAD™ 400 µm Flip Chip: package description and recommendations for use"  
 AN1751, "EMI filters: recommendations and measurements"  
 AN4541, "EMI filters for SD3.0 card: High speed SD card and filtering devices"

### 3 Ordering information

Figure 14. Ordering information scheme

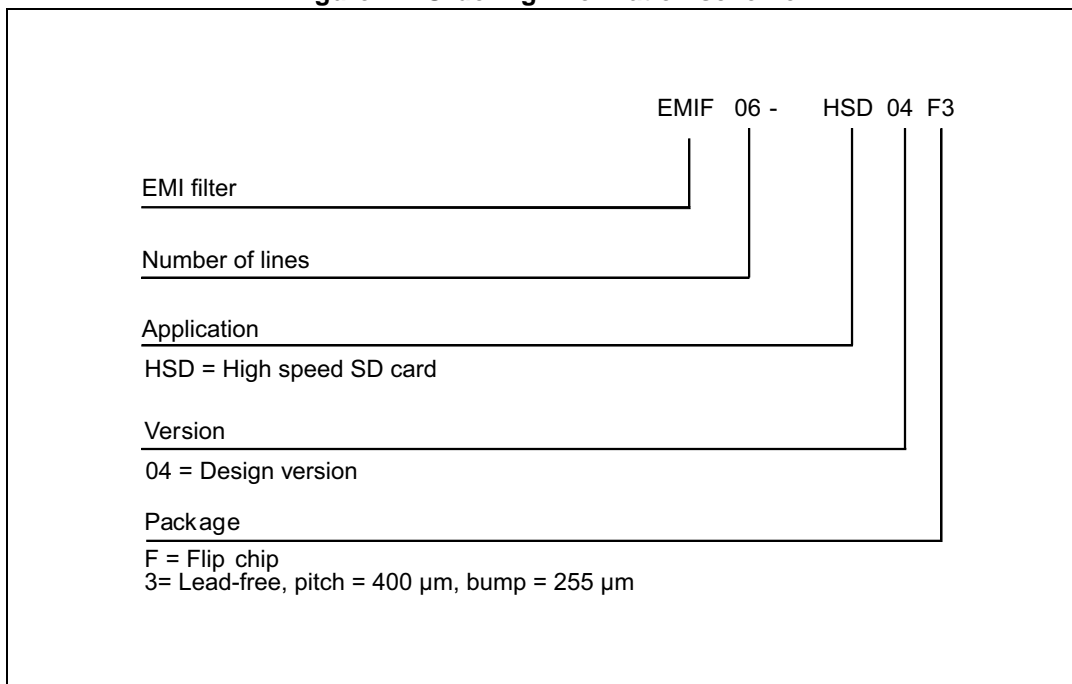

Table 5. Ordering information

Order code	Marking	Package	Weight	Base qty	Delivery mode
EMIF06-HSD04F3	LF	Flip Chip	2.77 mg	5000	Tape and reel (7")

### 4 Revision history

Table 6. Document revision history

Date	Revision	Changes
04-Nov-2014	1	Initial release

**IMPORTANT NOTICE – PLEASE READ CAREFULLY**

STMicroelectronics NV and its subsidiaries ("ST") reserve the right to make changes, corrections, enhancements, modifications, and improvements to ST products and/or to this document at any time without notice. Purchasers should obtain the latest relevant information on ST products before placing orders. ST products are sold pursuant to ST's terms and conditions of sale in place at the time of order acknowledgement.

Purchasers are solely responsible for the choice, selection, and use of ST products and ST assumes no liability for application assistance or the design of Purchasers' products.

No license, express or implied, to any intellectual property right is granted by ST herein.

Resale of ST products with provisions different from the information set forth herein shall void any warranty granted by ST for such product.

ST and the ST logo are trademarks of ST. All other product or service names are the property of their respective owners.

Information in this document supersedes and replaces information previously supplied in any prior versions of this document.

© 2014 STMicroelectronics – All rights reserved