



ON Semiconductor®

<http://onsemi.com>

EMH2418R

N-Channel Power MOSFET 24V, 9A, 15mΩ, Dual EMH8

Features

- Low On-resistance
- 2.5V drive
- Common-Drain Type
- Protection diode in
- Built-in gate protection resistor
- Best suited for LiB charging and discharging switch
- Halogen free compliance

Specifications

Absolute Maximum Ratings at $T_a = 25^\circ\text{C}$

Parameter	Symbol	Value	Unit
Drain to Source Voltage	V_{DSS}	24	V
Gate to Source Voltage	V_{GSS}	± 12	V
Drain Current (DC)	I_D	9	A
Drain Current (Pulse)	I_{DP}	40	A
$PW \leq 10\mu\text{s}$, duty cycle $\leq 1\%$			
Power Dissipation	P_D	1.3	W
When mounted on ceramic substrate(900mm ² ×0.8mm) 1unit			
Total Dissipation	P_T	1.4	W
When mounted on ceramic substrate(900mm ² ×0.8mm)			
Junction Temperature	T_j	150	°C
Storage Temperature	T_{stg}	- 55 to +150	°C

Thermal Resistance Ratings

Parameter	Symbol	Value	Unit
Junction to Ambient	$R_{\theta JA}$	96	°C/W
When mounted on ceramic substrate(900mm ² ×0.8mm)			

Electrical Connection

N-channel

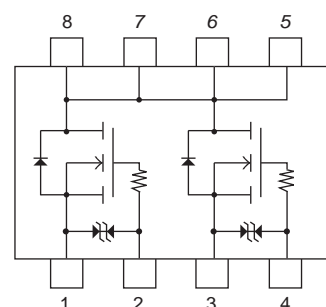

Marking

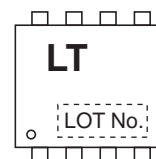

Packing Type: TL

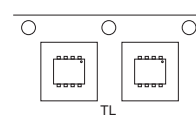

Ordering & Package Information

Device	Package	Shipping
EMH2418R-TL-H Pb-free and Halogen Free	EMH8	3,000 pcs. / reel

Stresses exceeding Maximum Ratings may damage the device. Maximum Ratings are stress ratings only. Functional operation above the Recommended Operating Conditions is not implied. Extended exposure to stresses above the Recommended Operating Conditions may affect device reliability.

EMH2418R

Electrical Characteristics at $T_a = 25^\circ\text{C}$

Parameter	Symbol	Conditions	Value			Unit
			min	typ	max	
Drain to Source Breakdown Voltage	$V_{(BR)DSS}$	$I_D=1\text{mA}, V_{GS}=0\text{V}$	24			V
Zero-Gate Voltage Drain Current	I_{DSS}	$V_{DS}=20\text{V}, V_{GS}=0\text{V}$			1	μA
Gate to Source Leakage Current	I_{GSS}	$V_{GS}=\pm 8\text{V}, V_{DS}=0\text{V}$			± 1	μA
Gate Threshold Voltage	$V_{GS(th)}$	$V_{DS}=10\text{V}, I_D=1\text{mA}$	0.5		1.3	V
Forward Transconductance	g_{FS}	$V_{DS}=10\text{V}, I_D=4\text{A}$		4		S
Static Drain to Source On-State Resistance	$R_{DS(on)1}$	$I_D=4\text{A}, V_{GS}=4.5\text{V}$	9.6	12	15	$\text{m}\Omega$
	$R_{DS(on)2}$	$I_D=4\text{A}, V_{GS}=4.0\text{V}$	10.0	12.5	16.3	$\text{m}\Omega$
	$R_{DS(on)3}$	$I_D=4\text{A}, V_{GS}=3.1\text{V}$	11.3	14.2	20	$\text{m}\Omega$
	$R_{DS(on)4}$	$I_D=2\text{A}, V_{GS}=2.5\text{V}$	13.2	16.5	23.1	$\text{m}\Omega$
Turn-ON Delay Time	$t_d(on)$	See specified Test Circuit.		120		ns
Rise Time	t_r			170		ns
Turn-OFF Delay Time	$t_d(off)$			17500		ns
Fall Time	t_f			22600		ns
Total Gate Charge	Q_g	$V_{DS}=10\text{V}, V_{GS}=4.5\text{V}, I_D=9\text{A}$		4.4		nC
Gate to Source Charge	Q_{gs}			0.9		nC
Gate to Drain "Miller" Charge	Q_{gd}			0.7		nC
Forward Diode Voltage	V_{SD}	$I_S=9\text{A}, V_{GS}=0\text{V}$		0.8	1.2	V

Switching Time Test Circuit

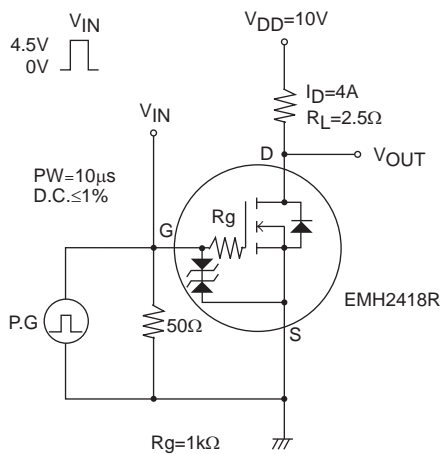

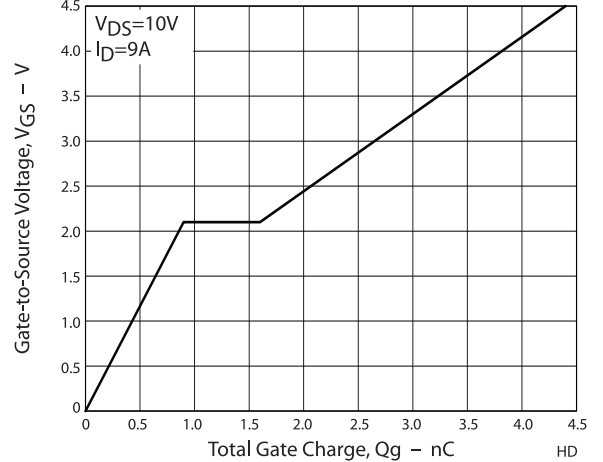
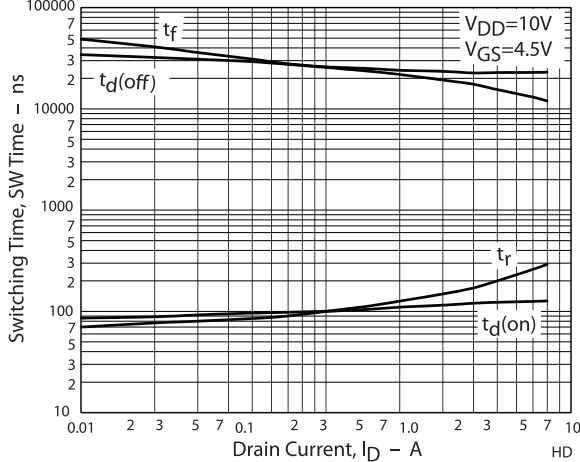
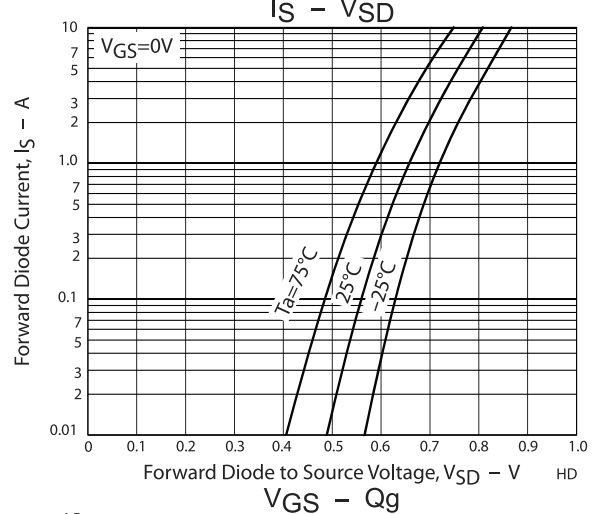
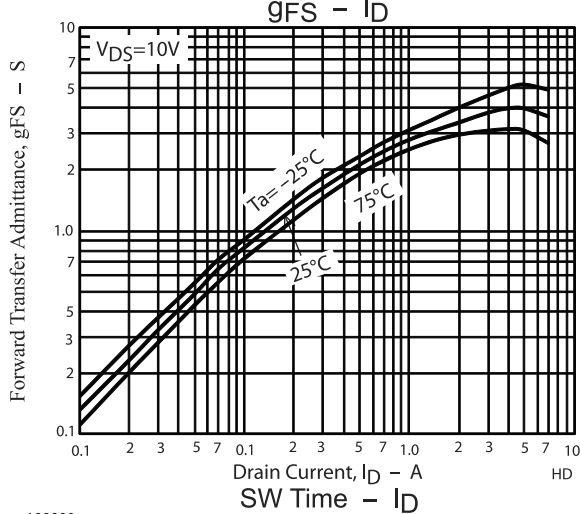
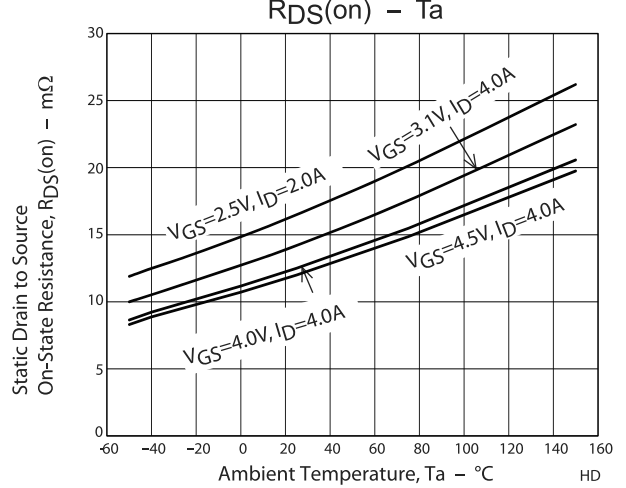
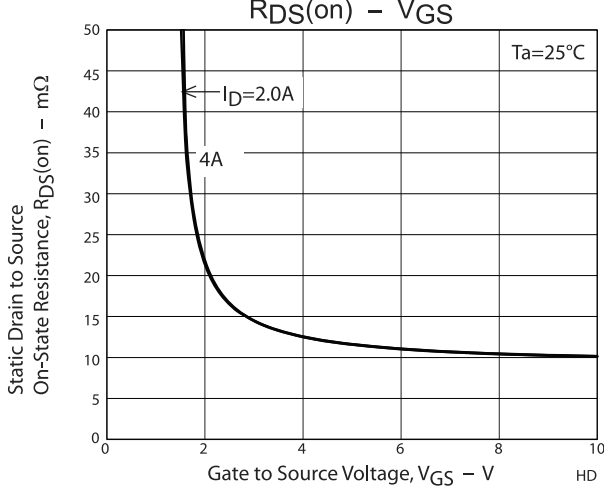
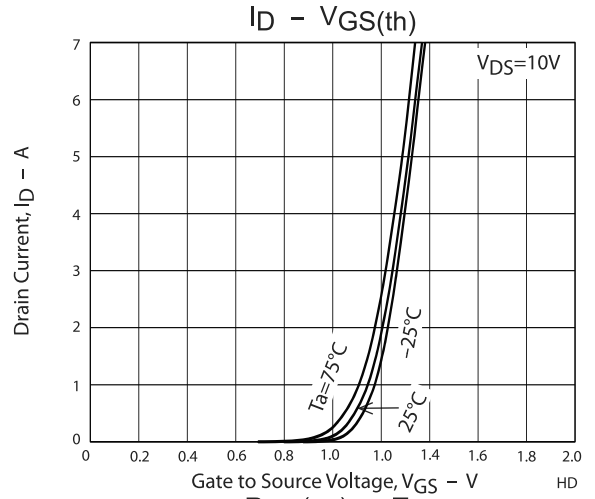
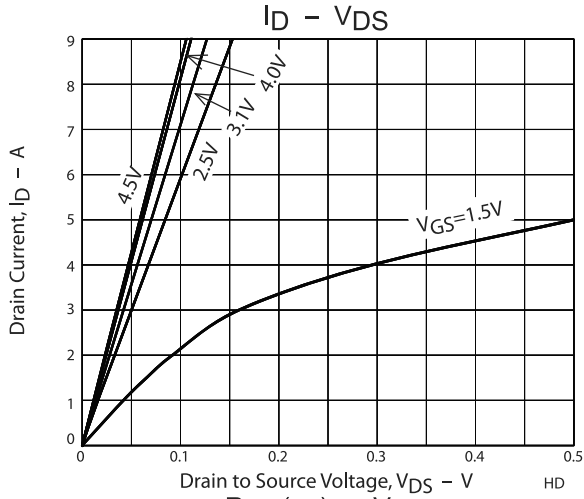

EMH2418R

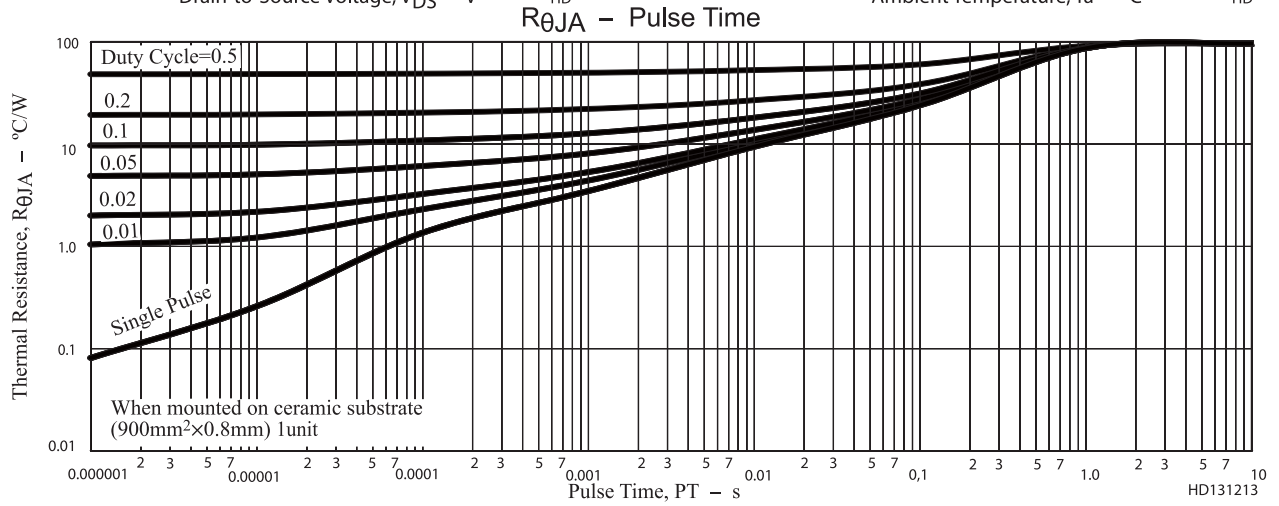
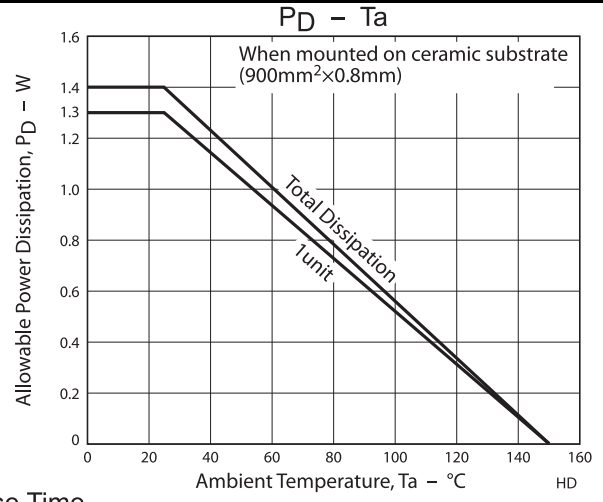
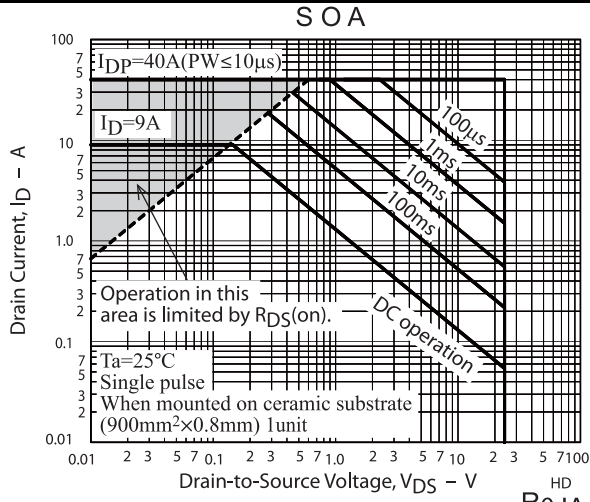

EMH2418R

Package Dimensions

EMH2418R-TL-H

SOT-383FL/EMH8

CASE419AT

ISSUE O

Unit : mm

- 1: Source1
- 2: Gate1
- 3: Source2
- 4: Gate2
- 5: Drain
- 6: Drain
- 7: Drain
- 8: Drain

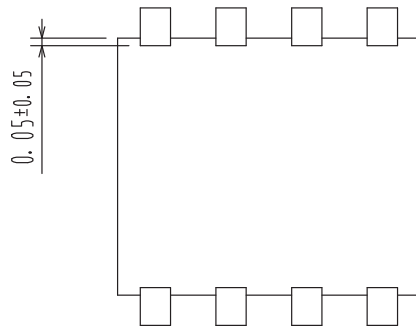
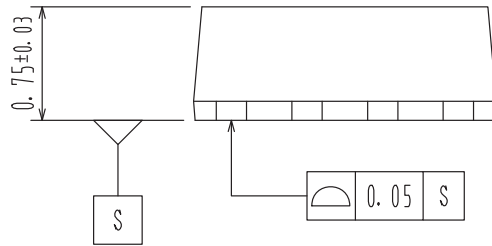
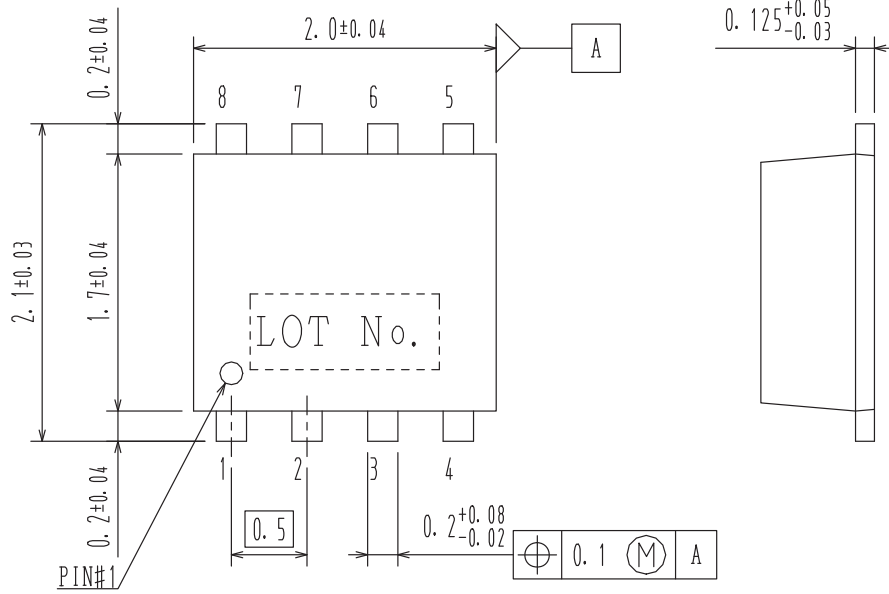

Soldering Footprint

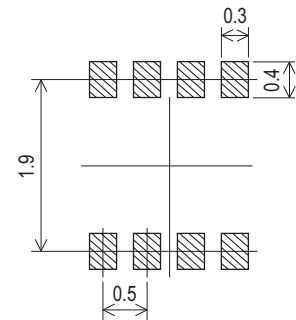

Note on usage : Since the EMH2418R is a MOSFET product, please avoid using this device in the vicinity of highly charged objects.

ON Semiconductor and the ON logo are registered trademarks of Semiconductor Components Industries, LLC (SCILLC). SCILLC owns the rights to a number of patents, trademarks, copyrights, trade secrets, and other intellectual property. A listing of SCILLC's product/patent coverage may be accessed at www.onsemi.com/site/pdf/Patent-Marking.pdf. SCILLC reserves the right to make changes without further notice to any products herein. SCILLC makes no warranty, representation or guarantee regarding the suitability of its products for any particular purpose, nor does SCILLC assume any liability arising out of the application or use of any product or circuit, and specifically disclaims any and all liability, including without limitation special, consequential or incidental damages. "Typical" parameters which may be provided in SCILLC data sheets and/or specifications can and do vary in different applications and actual performance may vary over time. All operating parameters, including "Typicals" must be validated for each customer application by customer's technical experts. SCILLC does not convey any license under its patent rights nor the rights of others. SCILLC products are not designed, intended, or authorized for use as components in systems intended for surgical implant into the body, or other applications intended to support or sustain life, or for any other application in which the failure of the SCILLC product could create a situation where personal injury or death may occur. Should Buyer purchase or use SCILLC products for any such unintended or unauthorized application, Buyer shall indemnify and hold SCILLC and its officers, employees, subsidiaries, affiliates, and distributors harmless against all claims, costs, damages, and expenses, and reasonable attorney fees arising out of, directly or indirectly, any claim of personal injury or death associated with such unintended or unauthorized use, even if such claim alleges that SCILLC was negligent regarding the design or manufacture of the part. SCILLC is an Equal Opportunity/Affirmative Action Employer. This literature is subject to all applicable copyright laws and is not for resale in any manner.