

KENWOOD

DNX7230DAB DNX5230BT DNX5230DAB DNX4230DAB DNX4230BT

GPS NAVIGATION SYSTEM
Quick Start Guide

JVC KENWOOD Corporation



About the Quick Start Guide

This Quick Start Guide explains the basic functions of this unit. For functions not covered in this guide, refer to the Instruction Manual (PDF file) contained in the included CD-ROM "Instruction Manual".

To refer to the Instruction Manual contained in the CD-ROM, a PC loaded with Microsoft® Windows XP/ Vista/7 or Mac OS X® 10.4 or later is required in addition to Adobe® Reader™ 7.1 or Adobe® Acrobat® 7.1 or later.

The Instruction Manual is subject to change for modification of specifications and so forth. You can download the latest version of the Instruction Manual from <http://manual2.jvckenwood.com/edition/im366>.

NOTE

- The panels shown in this guide are examples used to provide clear explanations of the operations. For this reason, they may be different from the actual panels.
 - In this manual, each model name is abbreviated as follows.
 DNX7230DAB: **DNX7**
 DNX5230DAB, DNX5230BT: **DNX5**
 DNX4230DAB, DNX4230BT: **DNX4**
- If above icons are showed, read the article applicable to the unit you use.
- In operation procedures, bracket shape indicates the key or button you should control.
 < >: indicates the name of panel buttons.
 []: indicates the name of touch keys.

Contents

Precautions	3
▲WARNING _____	3
Cleaning the Unit _____	4
How to Reset Your Unit _____	4
Safety Precautions and Important Information	5
▲WARNINGS _____	5
▲CAUTIONS _____	5
IMPORTANT INFORMATION _____	5
First Step	6
Basic Operations	8
Functions of the Buttons on the Front Panel _____	8
Common Operations _____	14
Detaching The Front Panel _____	15
How to Use the Navigation System	16
Other Features _____	18
How to Play Music	19
How to Play Movie/Picture	21
How to Listen to the Radio	22
How to Make a Phone Call	23
Installation Procedure	25
Before Installation _____	25
Installation Procedure _____	26
Removing Procedure _____	28
Connection _____	30
About this Unit _____	33

Precautions

⚠ WARNING

To prevent injury or fire, take the following precautions:

- To prevent a short circuit, never put or leave any metallic objects (such as coins or metal tools) inside the unit.
- Do not watch or fix your eyes on the unit's display when you are driving for any extended period.
- If you experience problems during installation, consult your Kenwood dealer.

Precautions on using this unit

- When you purchase optional accessories, check with your Kenwood dealer to make sure that they work with your model and in your area.
- You can select language to display menus, audio file tags, etc. See **Language setup (P.79)** in the Instruction Manual.
- The Radio Data System or Radio Broadcast Data System feature won't work where the service is not supported by any broadcasting station.
- The unit may not function properly if the connectors between the unit and front panel are dirty. Detach the front panel and clean the connector with a cotton swab gently, being careful not to damage the connector.

Precautions on battery

- Put the remote control in a place where it will not move during braking or other operations. A dangerous situation could result, if the remote control falls down and gets wedged under the pedals while driving.
- Do not leave the battery near fire or under direct sunlight. A fire, explosion or excessive heat generation may result.
- Do not recharge, short, break up or heat the battery or place it in an open fire. Such actions may cause the battery to leak fluid. If spilled fluid comes in contact with your eyes or on clothing, immediately rinse with water and consult a physician.
- Place the battery out of reach of children. In the

unlikely event that a child swallows the battery, immediately consult a physician.

Protecting the monitor

To protect the monitor from damage, do not operate the monitor using a ballpoint pen or similar tool with the sharp tip.

Lens fogging

When you turn on the car heater in cold weather, dew or condensation may form on the lens in the disc player of the unit. Called lens fogging, this condensation on the lens may not allow discs to play. In such a situation, remove the disc and wait for the condensation to evaporate. If the unit still does not operate normally after a while, consult your Kenwood dealer.

Precautions on handling discs

- Do not touch the recording surface of the disc.
- Do not stick tape etc. on the disc, or use a disc with tape stuck on it.
- Do not use disc type accessories.
- Clean from the center of the disc and move outward.
- When removing discs from this unit, pull them out horizontally.
- If the disc center hole or outside rim has burrs, use the disc only after removing the burrs with a ballpoint pen etc.
- Discs that are not round cannot be used.

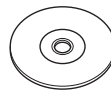

- 8-cm (3 inch) discs cannot be used.
- Discs with coloring on the recording surface or discs that are dirty cannot be used.
- This unit can only play the CDs with . This unit may not correctly play discs which do not have the mark.
- You cannot play a disc that has not been finalized. (For the finalization process see your writing software, and your recorder instruction manual.)

Acquiring GPS signal

The first time you turn on this unit, you must wait while the system acquires satellite signals for the first time. This process could take up to several minutes. Make sure your vehicle is outdoors in an open area away from tall buildings and trees for fastest acquisition. After the system acquires satellites for the first time, it will acquire satellites quickly each time thereafter.

About the front panel **DNX7**

When removing the product from the box or installing it, the front panel may be positioned at the angle shown in (Fig. 1). This is due to the characteristics of mechanism the product is equipped with.

When the product is first powered on works properly, the front panel will automatically move into the position (initial setting angle) shown in (Fig. 2).



(Fig. 1)

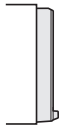

(Fig. 2)

Cleaning the Unit

If the front panel of this unit is stained, wipe it with a dry soft cloth such as a silicon cloth. If the front panel is stained badly, wipe the stain off with a cloth moistened with neutral cleaner, then wipe it again with a clean soft dry cloth.



- Applying spray cleaner directly to the unit may affect its mechanical parts. Wiping the front panel with a hard cloth or using a volatile liquid such as thinner or alcohol may scratch the surface or erase screened print.

How to Reset Your Unit

If the unit or the connected unit fails to operate properly, reset the unit.

1 Press the <Reset> button.

The unit returns to factory settings.

DNX7

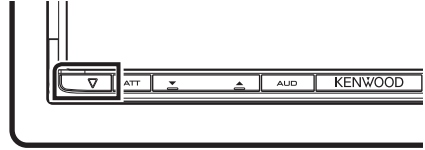

DNX5

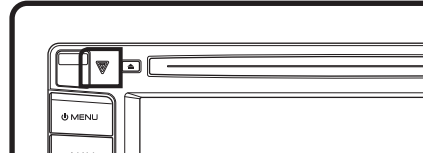

DNX4

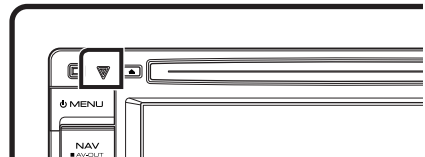

NOTE

- Disconnect the USB device before pressing the <Reset> button. Pressing the <Reset> button with the USB device connected can damage the data stored in the USB device. For how to disconnect the USB device, see **How to Play Music (P.19)**.
- When the unit is turned on after resetting, the Initial SETUP screen appears. See **First Step (P.6)**.

Safety Precautions and Important Information

Read this information carefully before starting to operate the Kenwood Car Navigation System and follow the instructions in this manual. Neither Kenwood nor Garmin shall be liable for problems or accidents resulting from failure to observe the instructions in this manual.

⚠️ WARNINGS

Failure to avoid the following potentially hazardous situations could result in an accident or collision resulting in death or serious injury.

When navigating, carefully compare information displayed on the navigation system to all available navigation sources, including information from street signs, visual sightings, and maps. For safety, always resolve any discrepancies or questions before continuing navigation.

Always operate the vehicle in a safe manner.

Do not become distracted by the navigation system while driving, and always be fully aware of all driving conditions. Minimize the amount of time spent viewing the screen of the navigation system while driving, and use voice prompts when possible.

Do not enter destinations, change settings, or access any functions requiring prolonged use of the navigation system controls while driving. Stop your vehicle in a safe and legal manner before attempting such operations.

Keep the system volume at a low enough level to be able to hear outside noises while driving. If you can no longer hear outside noises, you may be unable to react adequately to the traffic situation. This may cause accidents.

The navigation system will not display the correct current position of the vehicle the first time it is used after purchase, or if the vehicle battery is disconnected. GPS satellite signals will soon be received, however, and the correct position will be displayed.

Be careful of the ambient temperature. Using the navigation system at extreme temperatures can lead to malfunction or damage. Also note that the unit can be damaged by strong vibration, by metal objects, or by water getting inside the unit.

⚠️ CAUTIONS

Failure to avoid the following potentially hazardous situations may result in injury or property damage.

The navigation system is designed to provide you with route suggestions. It does not reflect road closures or road conditions, weather conditions, or other factors that may affect safety or timing while driving.

Use the navigation system only as a navigational aid. Do not attempt to use the navigation system for any purpose requiring precise measurement of direction, distance, location, or topography.

The Global Positioning System (GPS) is operated by the United States government, which is solely responsible for its accuracy and maintenance. The government system is subject to changes that could affect the accuracy and performance of all GPS equipment, including the navigation system. Although the navigation system is a precision navigation device, any navigation device can be misused or misinterpreted and, therefore, become unsafe.

IMPORTANT INFORMATION

Vehicle Battery Preservation

This navigation system can be used when the ignition key is turned to ON or ACC. To preserve the battery, however, it should be used with the engine running whenever possible. Using the navigation system for a long time with the engine switched off can cause the battery to run down.

Map Data Information

One of the goals of Garmin is to provide customers with the most complete and accurate cartography that is available to us at a reasonable cost. We use a combination of governmental and private data sources, which we identify in product literature and copyright messages displayed to the consumer. Virtually all data sources contain some inaccurate or incomplete data. In some countries, complete and accurate map information is either not available or is prohibitively expensive.

First Step

Power on the unit and perform some setup steps before using.
Press the <MENU> button.

DNX7

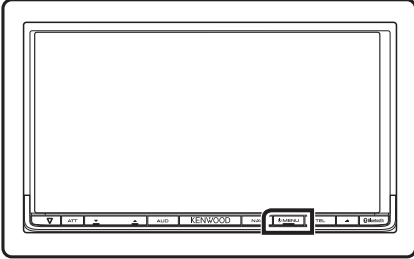

DNX5

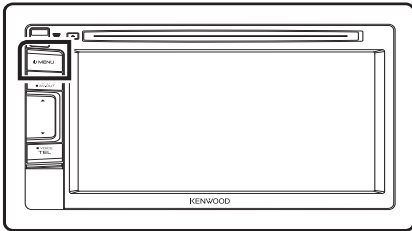

DNX4

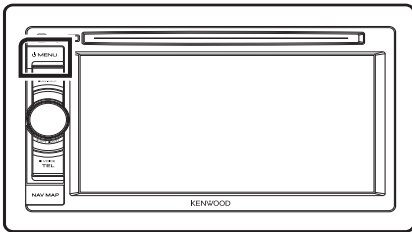

The unit is turned on.

The "Initial setup" is only necessary when you use the unit for the first time after purchase, and when you reset the unit.

1 Touch the corresponding key and set the value.



Language

Select the language used for the control screen and setting items. Default is "British English (en)". (Instruction Manual P.79)
After setting, touch [Enter].

Angle DNX7

Adjust the position of the monitor. Default is "0". (Instruction Manual P.82)
After setting, touch [↩].

iPod AV Interface Use

Set the terminal which your iPod is connected to. Default is "iPod". (Instruction Manual P.88)

Color

Set the screen and button illumination color. You can select whether to perform color scan and adjust scanning color. (Instruction Manual P.83)

After setting, touch [↩].

Camera

Set the parameters for the camera. (Instruction Manual P.86)

After setting, touch [↩].

2 Touch [Finish].

NOTE

- For details on operations of each setting, refer to the Instruction Manual.

Basic Operations

Functions of the Buttons on the Front Panel

DNX7230DAB

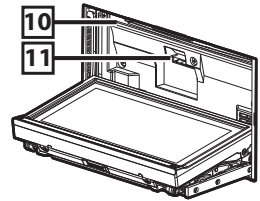
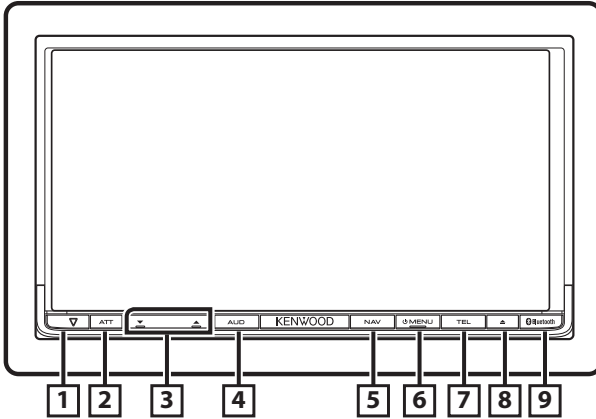

How to insert an SD Card

- 1) Press **8** <▲> button for 1 second.
The panel fully opens.
- 2) Hold the SD card as the illustration in the right and insert it into the slot until it clicks.

● To eject the card:

- Push the card until it clicks and then remove your finger from the card.
The card pops up so that you can pull it out with your fingers.

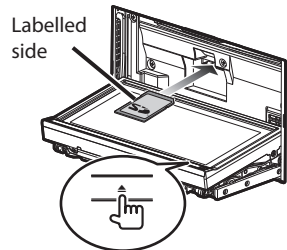

Number	Name	Motion
1	▽ (Reset)	<ul style="list-style-type: none"> If the unit or the connected unit fails to operate properly, the unit returns to factory settings when this button is pressed (Instruction Manual P.109). If the Security Indicator (SI) function is turned on, this indicator flashes when the vehicle ignition is off (Instruction Manual P.80).
2	ATT	<ul style="list-style-type: none"> Switches attenuation of the volume on/off. Pressing for 1 second turns the screen off.
3	▼, ▲ (Vol)	Adjusts volume.
4	AUD	<ul style="list-style-type: none"> Displays Graphic Equalizer screen (Instruction Manual P.95)*. Pressing for 1 second switches camera view display on/off.
5	NAV	<ul style="list-style-type: none"> Displays the navigation screen. Pressing for 1 second switches AV out sources.
6	MENU	<ul style="list-style-type: none"> Displays the Top Menu screen (Instruction Manual P.19). Pressing for 1 second turns the power off. When the power off, turns the power on.
7	TEL	<ul style="list-style-type: none"> Displays the Hands Free screen (Instruction Manual P.64). Pressing for 1 second displays the Voice Recognition screen. (Instruction Manual P.72)
8	▲ (Eject)	<ul style="list-style-type: none"> Ejects the disc. When the panel is opened, pressing closes the panel and pressing for 1 second ejects the disc forcibly. When the panel is closed, pressing for 1 second fully opens the panel to the location of the SD card slot.
9	Remote Sensor	Receives the remote control signal.
10	Disc insert slot	A slot to insert a disc media.
11	SD card slot	A slot to insert an SD card. The card is used for upgrading the map. For how to upgrade the map, refer to the instruction manual of the navigation system. Also, you can play audio/visual file in the card.

*The display may not switch to the Graphic Equalizer screen in some conditions.

DNX5230DAB/DNX5230BT

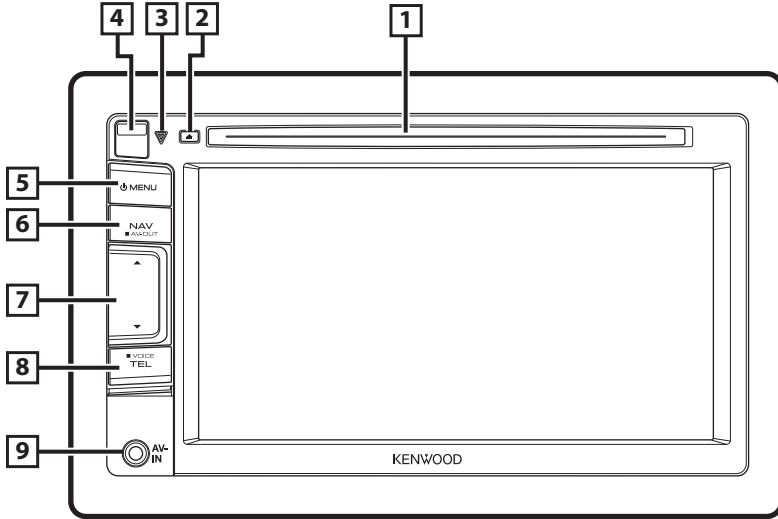

How to insert a microSD Card

- 1) Slide the **4** Release key upward to detach the part of the front panel.
- 2) Hold the microSD card with the label side facing left and the notched section up, and insert it into the slot until it clicks.

● To eject the card:

Push the card until it clicks and then remove your finger from the card.

The card pops up so that you can pull it out with your fingers.

● Attaching the front panel:

Hold the panel securely so as not to drop it accidentally, and fit it onto the attaching plate until it is firmly locked.

NOTE

- When detaching a part of the front panel, detach it toward the front side as shown in the diagram right. If it is detached upward, the front panel will be broken.

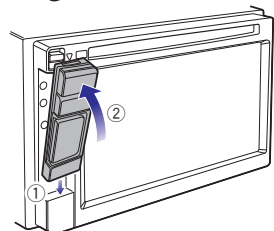
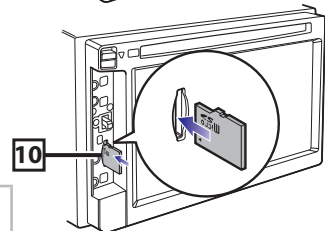
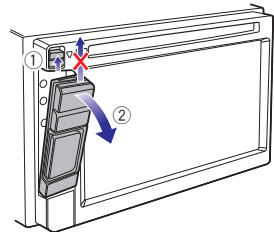

Number	Name	Motion
1	Disc insert slot	A slot to insert a disc media.
2	▲ (Eject)	<ul style="list-style-type: none"> Ejects the disc. Pressing for 1 second ejects the disc forcibly.
3	▽ (Reset)	<ul style="list-style-type: none"> If the unit or the connected unit fails to operate properly, the unit returns to factory settings when this button is pressed (Instruction Manual P.109). If the Security Indicator (SI) function is turned on, this indicator flashes when the vehicle ignition is off (Instruction Manual P.80).
4	Release key	Detaches the part of front panel.
5	MENU	<ul style="list-style-type: none"> Displays the Top Menu screen (Instruction Manual P.19). Pressing for 1 second turns the power off. When the power off, turns the power on.
6	NAV	<ul style="list-style-type: none"> Displays the navigation screen. Pressing for 1 second switches AV out sources.
7	▼, ▲	<ul style="list-style-type: none"> Adjusts volume.
8	TEL	<ul style="list-style-type: none"> Displays the Hands Free screen (Instruction Manual P.64). Pressing for 1 second displays the Voice Recognition screen. (Instruction Manual P.72)
9	Input jack	An input jack for external device.
10	microSD card slot	<p>A slot to insert an SD card. The card is used for upgrading the map. For how to upgrade the map, refer to the instruction manual of the navigation system.</p> <p>Also, you can play audio/visual file in the card.</p>

DNX4230DAB/DNX4230BT

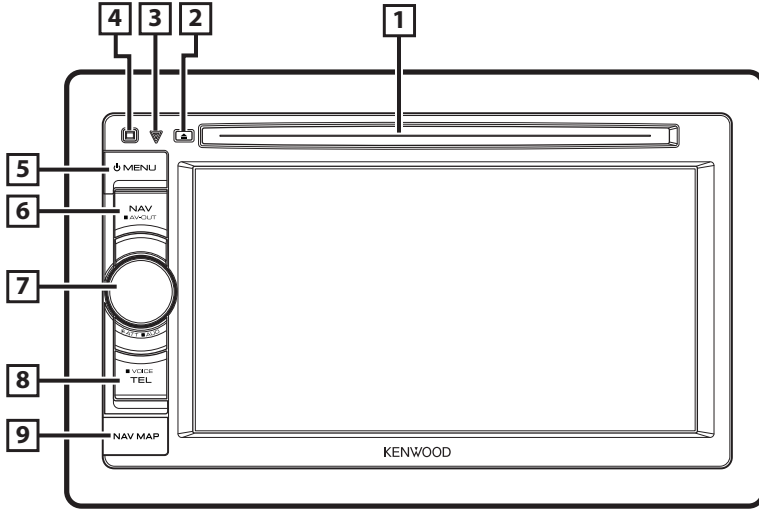

How to insert a microSD Card

- 1) Open the **9** microSD card slot cover as the illustration in the right.
- 2) Hold the microSD card with the label facing up and the notched section right, and insert it into the slot until it clicks.

● To eject the card:

Push the card until it clicks and then remove your finger from the card.

The card pops up so that you can pull it out with your fingers.

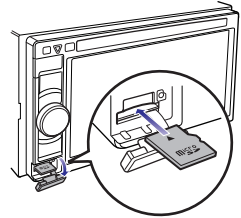

Number	Name	Motion
1	Disc insert slot	A slot to insert a disc media.
2	▲ (Eject)	<ul style="list-style-type: none"> Ejects the disc. Pressing for 1 second ejects the disc forcibly.
3	▽ (Reset)	<ul style="list-style-type: none"> If the unit or the connected unit fails to operate properly, the unit returns to factory settings when this button is pressed (Instruction Manual P.109). If the Security Indicator (SI) function is turned on, this indicator flashes when the vehicle ignition is off (Instruction Manual P.80).
4	Remote Sensor	Receives the remote control signal.
5	MENU	<ul style="list-style-type: none"> Displays the Top Menu screen (Instruction Manual P.19). Pressing for 1 second turns the power off. When the power off, turns the power on.
6	NAV	<ul style="list-style-type: none"> Displays the navigation screen. Pressing for 1 second switches AV out sources.
7	Volume Knob	<ul style="list-style-type: none"> Turning adjusts volume up or down. Pressing switches attenuation of the volume on/off. Pressing for 1 second displays Tone Control screen (Instruction Manual P.96)*.
8	TEL	<ul style="list-style-type: none"> Displays the Hands Free screen (Instruction Manual P.64). Pressing for 1 second displays the Voice Recognition screen. (Instruction Manual P.72)
9	microSD card slot	A microSD card slot for upgrading the map. For how to upgrade the map, refer to the instruction manual of the navigation system.

*The display may not switch to the Tone Control screen in some conditions.

Common Operations

General

There are some functions which can be operated from most screens.



[Menu]

Returns to the Top Menu screen. Touching for at least 1 second displays the Screen Control screen. (Even when an image is displayed, touching for at least 1 second displays the Screen Control screen.)

← (RETURN)

Returns to previous screen.

← (common menu key)

Touch to display the common menu. The contents of the menu are as follows.

- : **DNX7** Displays the EXT SW Control screen.
- : Displays the SETUP Menu screen.
- : Displays the Audio Control Menu screen.
- : Displays the control screen of current source. Icon feature differs depending on the source.
- : Closes the menu.

List screen

There are some common function keys in the list screens of most sources.



◀ (Scroll)

Scrolls the displayed text.

All > etc.

Touch keys with various functions are displayed here. Displayed keys differ depending on the current audio source, status, etc. For examples, see **List screen (P.21)** in the Instruction Manual.

Flick scrolling

You can scroll the list screen by flicking the screen up/down or right/left.



Detaching The Front Panel **DNX7** **DNX5**

You can detach the front panel to prevent theft.

DNX7

Press the <▲> button for 1 second to open the front panel.

Then, detach the panel as the diagrams below.

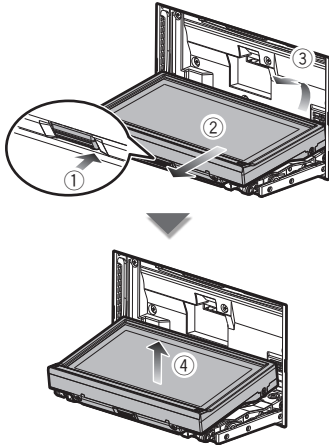

● After detaching

Put the panel in the protective bag supplied with the unit.

NOTE

- The attaching plate closes automatically in about 10 seconds after the front panel is released. Remove the panel before this happens.
- For attaching the panel, see **Attaching the front panel (P.27)**.

DNX5

Slide the Release key upward to detach the part of the front panel.

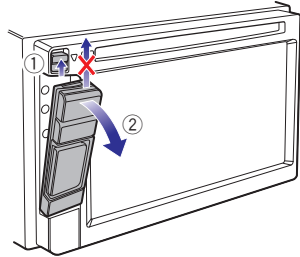

● Attaching the front panel

Hold the panel securely so as not to drop it accidentally, and fit it onto the attaching plate until it is firmly locked.

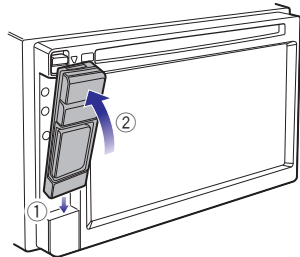

NOTE

- When detaching a part of the front panel, detach it toward the front side as shown in the diagram above. If it is detached upward, the front panel will be broken.
- To prevent deterioration, do not touch the terminals of the unit and front panel with your fingers.
- If the terminals on the unit or front panel get dirty, wipe them with a clean soft dry cloth.

How to Use the Navigation System

1 Press the <NAV> button to display the navigation screen.

2 Operate the desired function from the Main Menu screen.



1	GPS satellite strength.
2	Finds a destination.
3	Views the map.
4	Uses the Apps such as ecoRoute and Help.
5	Adjusts the settings.

NOTE

- You can get additional information about using the navigation system from Help. To display Help, touch [Apps] and then touch [Help].



- For more information about your navigation system, download the latest version of the Owner's Manual from manual.kenwood.com/edition/im366.

3 Enter your destination and start the guidance.

● **Finding points of interest**

- 1) Touch [Where To?].
- 2) Select a category and a subcategory.
- 3) Select a destination.
- 4) Touch [Go!].

NOTE

- To enter letters contained in the name, touch the Search bar and enter the letters.

4 Follow your route to the destination.

NOTICE

- The speed limit icon feature is for information only and does not replace the driver's responsibility to abide by all posted speed limit signs and to use safe driving judgment at all times. Garmin and JVC KENWOOD will not be responsible for any traffic fines or citations that you may receive for failing to follow all applicable traffic laws and signs.

Your route is marked with a magenta line. As you travel, your navigation system guides you to your destination with voice prompts, arrows on the map, and directions at the top of the map. If you depart from the original route, your navigation system recalculates the route.

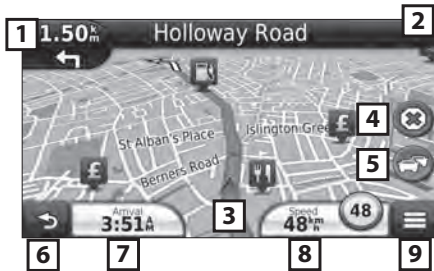

1	Views the Next Turn page or the junction view page, when available.
2	Views the Turn List page.
3	Views the Where Am I? page.
4	Stops the current route.
5	Displays traffic information on the route.
6	Returns to the Main menu.
7	Displays a different data field.
8	Views the Trip Computer.
9	Displays more options.



NOTE

- Touch and drag the map to view a different area of the map.
- A speed limit icon could appear as you travel on major roadways.

● Adding a stop

- 1) While navigating a route, touch [] and then touch [Where To?].
- 2) Search for the extra stop.
- 3) Touch [Go!].
- 4) Touch [Add to Active Route] to add this stop before your final destination.

● Taking a detour

- 1) While navigating a route, touch [].
- 2) Touch [].

Other Features

● Manually avoiding traffic on your route

- 1) From the map, touch the traffic icon.
- 2) Touch [Traffic On Route].
- 3) If necessary, touch the arrows to view other traffic delays on your route.
- 4) Touch [] > [Avoid].

● Viewing the traffic map

The traffic map shows color-coded traffic flow and delays on nearby.

● About traffic

NOTICE

- Traffic service is not available in some areas or countries.
- Garmin and JVC KENWOOD are not responsible for the accuracy or timeliness of the traffic information.

With an FM traffic receiver, the navigation system can receive and use traffic information. When a traffic message is received, you can see the event on the map and change your route to avoid the incident. The FM TMC subscription activates automatically after your navigation system acquires satellite signals while receiving traffic signals from the service provider. Go to www.garmin.com/fmtraffic for more information.

● Updating the software

To update the navigation system software, you must have a USB mass storage device and an internet connection.

- 1) Go to www.garmin.com/Kenwood.
- 2) Find your model and select [Software Updates] > [Download].
- 3) Read and accept the terms of the Software License Agreement.
- 4) Follow the instructions on the Web site to complete the installation of the software update.

● Updating maps

You can purchase updated map data from Garmin or ask your Kenwood dealer or Kenwood service center for details.

- 1) Go to www.garmin.com/Kenwood.
- 2) Select [Order Map Updates] for your Kenwood unit.
- 3) Follow the Web site instructions to update your map.

How to Play Music

You can play audio files from music CD, disc media, USB storage device and iPod.

NOTE

• For details on playable file format, media format, iPod model, etc., refer to the Instruction Manual.

1 Connect the media you want to play as shown below.

Disc

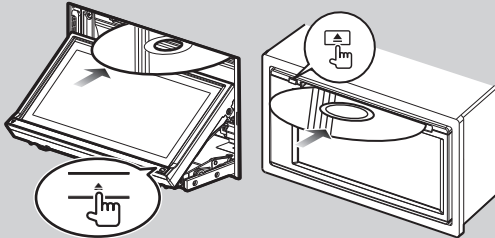

DNX7

- 1) Press the <▲> button to open the front panel.
- 2) Insert the disc into the slot.

● To eject the disc:

Press the <▲> button.

DNX5 DNX4

- 1) Insert the disc into the slot.
→ *Playback starts.*

● To eject the disc:

Press the <▲> button.

iPod, USB device

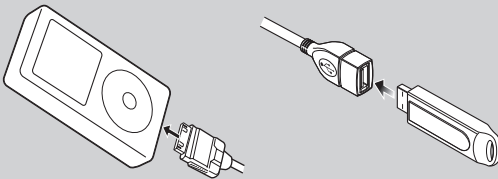

- 1) Connect the device with each cable.

→ *Playback starts.*

● To disconnect the device:

Touch [⏪] on the screen and then touch [▲].

Disconnect the device from the cable.

SD card

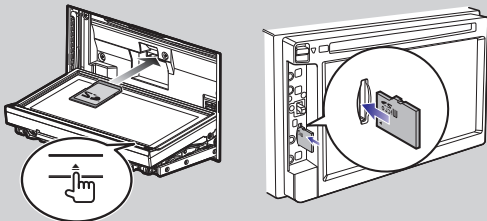

DNX7

- 1) Press [▲] for longer than 1 second to open the front panel and insert the card.

DNX5

- 1) Detach the front panel and insert the card.

- 2) Attaching the front pane.

→ *Playback starts.*

● To eject the card:

Push the card until it clicks and then remove your finger from the card. The card pops up so that you can pull it out.

Continued

2 Control the music you are listening to on the source control screen.

The following symbols indicate the keys on the screen.

The functions of the keys are the same despite the difference of the source you are listening to.

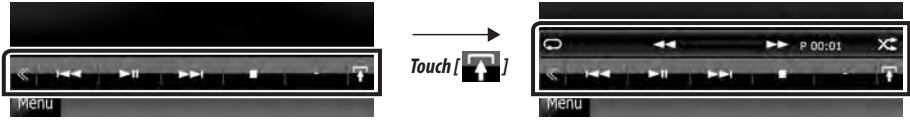

Basic operations from this screen

Plays or pauses:	
Stops playing:	
Disconnects the device:	
Searches the previous/next content:	
Fast forwards or Fast backwards (Disc media, CD, USB device only):	or move the cursor in the center bar
Repeats current content:	
Plays all contents in random order:	

NOTE

- For other operations, refer to the Instruction Manual.
- If desired key is not displayed in the multi-function bar, touch the [] to switch the menu.

3 Search the track/file you want to listen to.

● List search

- 1) Touch center of the screen.

The content list of the media being played is displayed.

If the information of the current track only is displayed, touch [] to switch the list display.



● Refined search

- 1) Touch [].
- 2) Touch the desired refinement method.
The list is refined by the item you selected.
- 3) Touch the desired item.



NOTE

- For details on searching operations, refer to **Search Operation (P.40)** in the Instruction Manual.

How to Play Movie/Picture

You can play DVD video, Video CD (VCD), movie files from disc media, iPod and picture files from USB storage device.

NOTE

- For details on playable file format, device format, etc., refer to the Instruction Manual.

1 Connect the media you want to play.

For the method of connecting, see **How to Play Music (P.19)**.

2 Control the movie/picture by touching the screen.

Each area on the screen has a separate function.



1	2	3
DVD: Displays the DVD menu.* ¹ VCD: Displays the Zoom Control screen.* ² Disc media: Displays the disc menu.* ³	Displays the Source Control screen.	<ul style="list-style-type: none"> • Searches the next/previous content or file. • Scrolling from center of display to left or right performs fast backward or fast forward. To stop fast backward/forward, touch center of the display.*⁴



*¹ See **DVD Disc Menu Operation (P.27)** in the Instruction Manual.

*² See **Zoom Control For DVD And VCD (P.28)** in the Instruction Manual.

*³ See **Movie Control (P.45)** in the Instruction Manual.

*⁴ For iPod/USB, this function may be unavailable depending on the playing file format.

NOTE

- For operations on the source control screen, see **How to Play Music (P.19)**. However, searching by category/link/album artwork is not available.
- Touching [] (displayed by touching [] in the source control screen) hides all keys.

How to Listen to the Radio

1 Touch [Menu] on any screen.

Top Menu screen appears.

2 Touch [TUNER].

The unit switches to the radio source.

3 Operate on the source control screen.

● Station search

- 1) Touch [].

Sub function menu appears.

- 2) Touch [AM] or [FM] to select the band.
- 3) Touch [◀◀] or [▶▶] to tune in the desired station.

● Auto memory

- 1) Touch [].

Sub function menu appears.

- 2) Touch [AM] or [FM] to select the band.
- 3) Touch [].
- 4) Touch [AME].
- 5) Touch [◀◀] or [▶▶] in the sub function menu.

Auto memory starts.

● Recalling the preset station

- 1) Touch [P#].

You can also display the preset list by touching the frequency display in the center.



NOTE

- For other operations, see **Radio Basic Operation (P.52)** in the Instruction Manual.

How to Make a Phone Call

You can use your Bluetooth cell-phone when paired to this unit.

1 Register your cell-phone to the unit.

Follow as the procedures shown below. For detailed operation, see **Registering the Bluetooth Unit (P.65)** in the Instruction Manual.

- 1) Touch [Menu] on any screen.
Top Menu screen appears.
- 2) Touch [SETUP].
SETUP Menu screen appears.
- 3) Touch [Bluetooth].
Bluetooth SETUP screen appears.
- 4) Touch [Search].
Searched Device List screen appears.
- 5) Touch [PIN Code Set] in the Searched Device List screen.
- 6) Enter PIN code and touch [Enter].
- 7) Select your cell-phone from the displayed list in the Searched Device List screen.
Registering is completed.



2 Connect your cell-phone to the unit.

- 1) Touch the device name you want to connect in the Bluetooth SETUP screen.
- 2) Touch [ON] of [TEL(HFP)] in the BT Connection Settings screen.
The selected device is connected to the unit.

When registration of your cell-phone is completed, the phone book of the cell-phone is automatically downloaded to this unit.

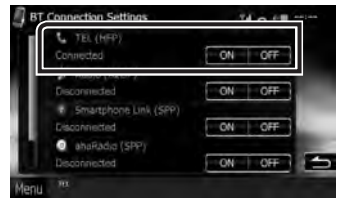

Continued

3 Make or receive a phone call.





See the table below for each operation method.





Call by entering a phone number

- ① Enter a phone number with number keys.
- ② Touch [].

Call using call records

- ① Touch [] (incoming calls), [] (missed calls), or [] (outgoing calls).
- ② Select the phone number from the list.
- ③ Touch [].

Call using the phonebook

- ① Touch [].
- ② Select the name from the list.
- ③ Select the number from the list.
- ④ Touch [].

Call using the preset number

- ① Touch [Preset #] to start calling the corresponding phone number.
- ② Touch [].

Call by voice

You can make a voice call using the voice recognition function of the cell-phone.

- ① Touch [].
- ② Pronounce the name registered in the cell-phone.

NOTE

- For detailed operation, see **Using Hands-Free Unit (P.67)** in the Instruction Manual.

Installation Procedure

Before Installation

Before installation of this unit, please note the following precautions.

⚠️ WARNINGS

- If you connect the ignition wire (red) and the battery wire (yellow) to the car chassis (ground), you may cause a short circuit, that in turn may start a fire. Always connect those wires to the power source running through the fuse box.
- Do not cut out the fuse from the ignition wire (red) and the battery wire (yellow). The power supply must be connected to the wires via the fuse.

⚠️ CAUTION

- Install this unit in the console of your vehicle. Do not touch the metal part of this unit during and shortly after the use of the unit. Metal part such as the heat sink and enclosure become hot.

NOTES

- Mounting and wiring this product requires skills and experience. For best safety, leave the mounting and wiring work to professionals.
- Make sure to ground the unit to a negative 12V DC power supply.
- Do not install the unit in a spot exposed to direct sunlight or excessive heat or humidity. Also avoid places with too much dust or the possibility of water splashing.
- Do not use your own screws. Use only the screws provided. If you use the wrong screws, you could damage the unit.
- If the power is not turned ON ("PROTECT" is displayed), the speaker wire may have a short-circuit or touched the chassis of the vehicle and the protection function may have been activated. Therefore, the speaker wire should be checked.
- If your car's ignition does not have an ACC position, connect the ignition wires to a power source that can be turned on and off with the ignition key. If you connect the ignition wire to a power source with a constant voltage supply, such as with battery wires, the battery may be drained.
- If the console has a lid, make sure to install the unit so that the front panel will not hit the lid when closing and opening.

- If the fuse blows, first make sure the wires aren't touching to cause a short circuit, then replace the old fuse with one with the same rating.
- Insulate unconnected wires with vinyl tape or other similar material. To prevent a short circuit, do not remove the caps on the ends of the unconnected wires or the terminals.
- Connect the speaker wires correctly to the terminals to which they correspond. The unit may be damaged or fail to work if you share the ⊖ wires or ground them to any metal part in the car.
- When only two speakers are being connected to the system, connect the connectors either to both the front output terminals or to both the rear output terminals (do not mix front and rear). For example, if you connect the ⊕ connector of the left speaker to a front output terminal, do not connect the ⊖ connector to a rear output terminal.
- After the unit is installed, check whether the brake lamps, blinkers, wipers, etc. on the car are working properly.
- Mount the unit so that the mounting angle is 30° or less.
- This unit has the cooling fan to decrease the internal temperature. Do not mount the unit in a place where the cooling fan of the unit are blocked. Blocking these openings will inhibit the cooling of the internal temperature and result in malfunction.

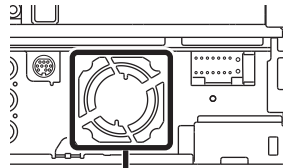

Cooling fan

- Do not press hard on the panel surface when installing the unit to the vehicle. Otherwise scars, damage, or failure may result.
- Reception may drop if there are metal objects near the Bluetooth antenna.

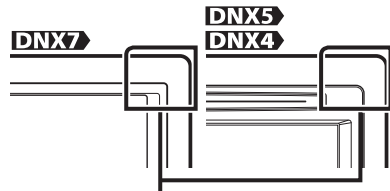





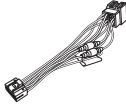
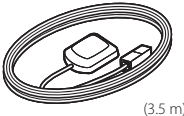

Bluetooth antenna unit

Installation Procedure

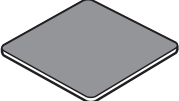
Supplied accessories

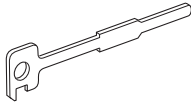
First of all, make sure that all accessories are supplied with the unit.

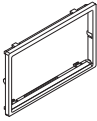
① ...1 	⑥ ...1 
② ...1 	⑦ ...1 
③ ...1* 	⑧ ...1 
④ ...2 	⑨ ...1* 
⑤ ...1 	

* **DNX7**

Unit

- 1 To prevent a short circuit, remove the key from the ignition and disconnect the \ominus terminal of the battery.
- 2 Make the proper input and output wire connections for each unit.
- 3 Connect the wire on the wiring harness.
- 4 Take Connector B on the wiring harness and connect it to the speaker connector in your vehicle.
- 5 Take Connector A on the wiring harness and connect it to the external power connector on your vehicle.
- 6 Connect the wiring harness connector to the unit.
- 7 Install the unit in your car.
- 8 Reconnect the \ominus battery.
- 9 Press the <Reset> button. **(P.4)**
- 10 Perform the Initial Setup. See **First Step (P.6)**.

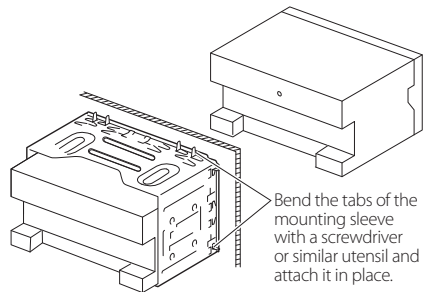

NOTE

- Make sure that the unit is installed securely in place. If the unit is unstable, it may malfunction (eg, the sound may skip).

Attaching the front panel DNX7

Hold the front panel securely so as not to drop it accidentally. Fit the panel onto the attaching plate until it is firmly locked.

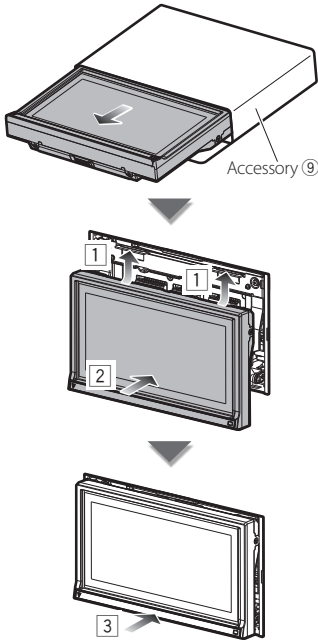

Trim plate

Attach accessory ⑤ to the unit.

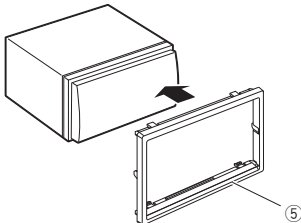

GPS antenna

GPS antenna is installed inside of the car. It should be installed as horizontally as possible to allow easy reception of the GPS satellite signals.

To mount the GPS antenna inside your vehicle:

- 1) Clean your dashboard or other surface.
- 2) Remove the separator of the metal plate (accessory ⑦).
- 3) Press the metal plate (accessory ⑦) down firmly on your dashboard or other mounting surface. You can bend the metal plate (accessory ⑦) to conform to a curved surface, if necessary.
- 4) Remove the separator of the GPS antenna (accessory ⑥), and stick the antenna to the metal plate (accessory ⑦).

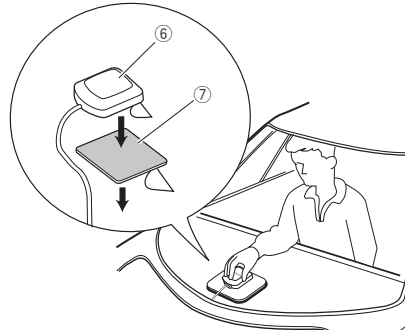

- Depending on the type of car, reception of the GPS satellite signals might not be possible with an inside installation.
- The GPS antenna should be installed at a position that is spaced at least 12 inch (30 cm) from cellular phone or other transmitting antennas. Signals from the GPS satellite may be interfered with by these types of communication.
- Painting the GPS antenna with (metallic) paint may cause a drop in performance.

Microphone unit

- 1) Check the installation position of the microphone (accessory ⑧).
- 2) Clean the installation surface.
- 3) Install the microphone.
- 4) Wire the microphone cable up to the unit with it secured at several positions using tape or other desired method.

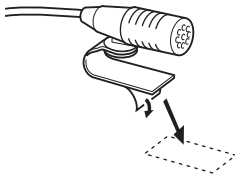
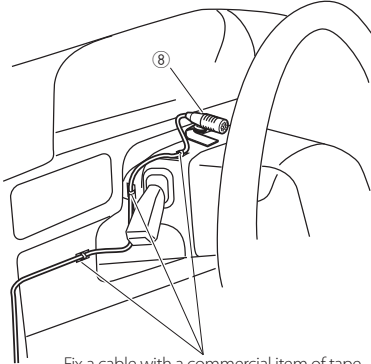

Remove the separator of the microphone, and stick the microphone to the place shown above.



Adjust the direction of the microphone to the driver.

NOTE

- Install the microphone as far as possible from the cell-phone.

Removing Procedure

Removing the trim plate

- 1) Engage the catch pins on the extraction key (accessory ④) and remove the two locks on the lower level.
Lower the trim plate (accessory ⑤) and pull it forward as shown in the figure.

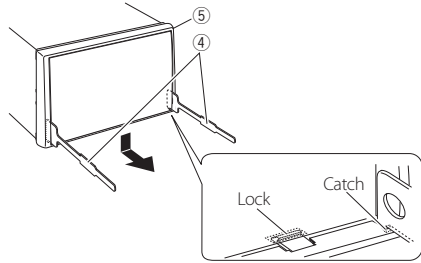

NOTE

- The trim plate can be removed from the top side in the same manner.

- 2) When the lower level is removed, remove the upper two locations.

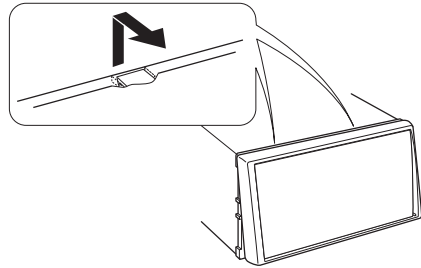

Removing the unit

- 1) Remove the trim plate by referring to **step 1 in "Removing the trim plate"**.
- 2) Insert the two extraction key (accessory ④) deeply into the slots on each side, as shown.

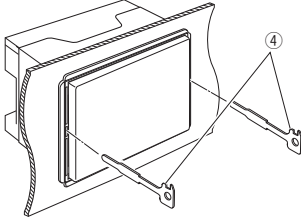

- 3) Lower the extraction key toward the bottom, and pull out the unit halfway while pressing towards the inside.

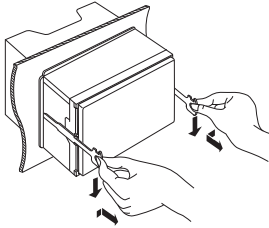

NOTE

- Be careful to avoid injury from the catch pins on the extraction key.

- 4) Pull the unit all the way out with your hands, being careful not to drop it.

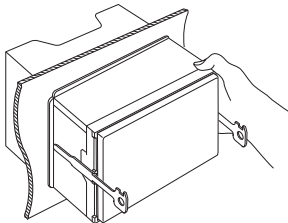

Connection

System connection

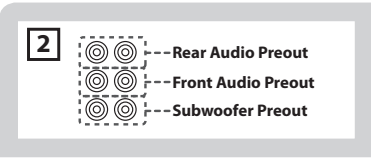
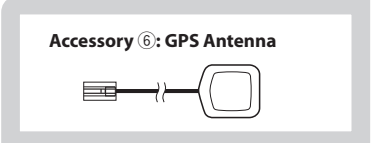
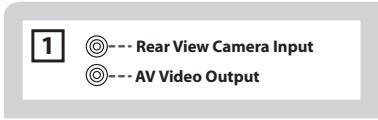
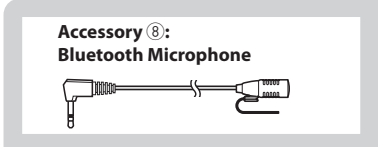
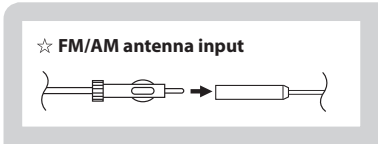
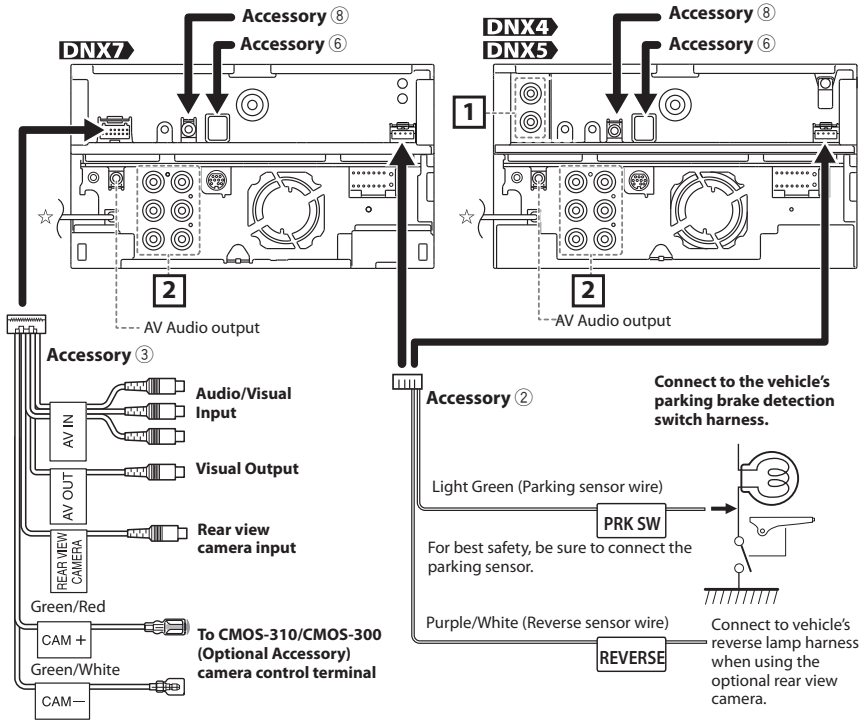

Connecting wires to terminals

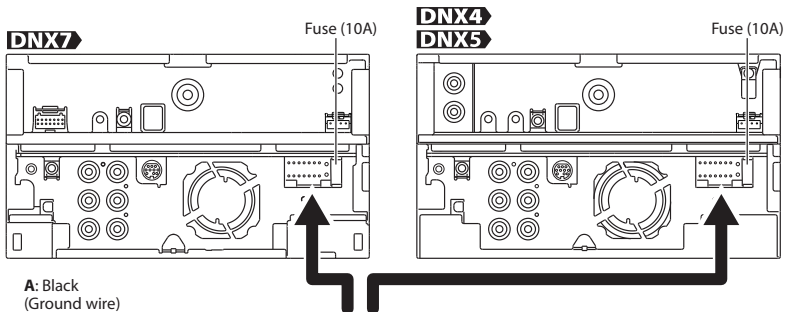

- A:** Black (Ground wire)
- B:** Yellow (Battery wire)
- C:** Red (Ignition wire)

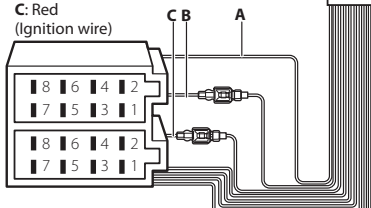

If no connections are made, do not let the wire come out from the tab.

Connect either to the power control terminal when using the optional power amplifier, or to the power terminal for the booster amplifier of the film-type or short pole type antenna.

Connect to the terminal that is grounded when either the telephone rings or during conversation.

To use the steering wheel remote control feature, an exclusive remote adapter (not supplied) that matches your car is required.

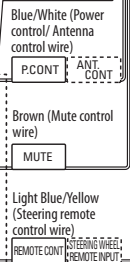

Accessory ①

Pin Numbers for ISO Connectors	Cable Color	Functions
External Power Connector		
A-4	Yellow	Battery
A-5	Blue/White	Power Control
A-6	Orange/White	Dimmer
A-7	Red	Ignition (ACC)
A-8	Black	Earth (Ground) Connection
Speaker Connector		
B-1	Purple	Rear Right (+)
B-2	Purple/Black	Rear Right (-)
B-3	Gray	Front Right (+)
B-4	Gray/Black	Front Right (-)
B-5	White	Front Left (+)
B-6	White/Black	Front Left (-)
B-7	Green	Rear Left (+)
B-8	Green/Black	Rear Left (-)

*Speaker Impedance: 4-8 Ω

▲ WARNING for Connecting the ISO Connector

The pin arrangement for the ISO connectors depends on the type of vehicle you drive. Make sure to make the proper connections to prevent damage to the unit. The default connection for the wiring harness is described in (1) below. If the ISO connector pins are set as described in (2), make the connection as illustrated. Please be sure to reconnect the cable as shown (2) below to install this unit to the **Volkswagen** vehicles etc.

(1): Default setting

The red (A-7 pin) of the vehicle's ISO connector is linked with the ignition, and the yellow (A-4 pin) is connected to the constant power supply.

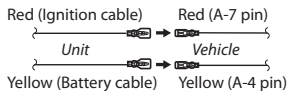

(2)

The red (A-7 pin) of the vehicle's ISO connector is connected to the constant power supply, and the yellow (A-4 pin) is linked to the ignition.

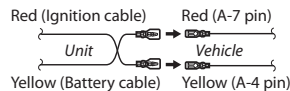

Optional accessory connection

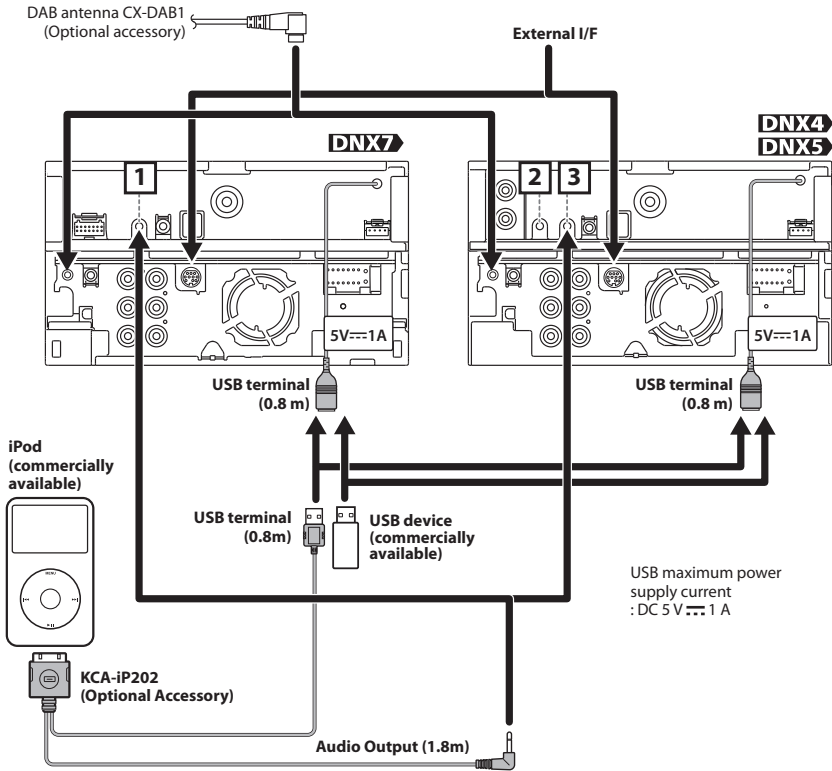

NOTE

- When iPod AV Interface Use is set to "AV-IN2" on the AV-IN SETUP screen, iPod can be connected only to the USB terminal using the KCA-iP102 (Optional Accessory).

- 1 iPod/ AV-IN2 (CA-C3AV; Optional Accessory) input
- 2 AV-IN (CA-C3AV; Optional Accessory) input **DNX4**
- 3 iPod/ AV-IN2 (CA-C3AV; Optional Accessory) input



Use of a CX-DAB1 (optional accessory) as a DAB antenna is recommended. When using a commercially available DAB antenna, the diameter of the SMB connector must be $\Phi 6.5$ mm or less.

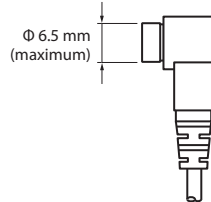

About this Unit

■ Copyrights

- The Bluetooth word mark and logos are owned by the Bluetooth SIG, Inc. and any use of such marks by JVC KENWOOD Corporation is under license. Other trademarks and trade names are those of their respective owners.
- The "AAC" logo is a trademark of Dolby Laboratories.
- "Made for iPod" and "Made for iPhone" mean that an electronic accessory has been designed to connect specifically to iPod or iPhone, respectively, and has been certified by the developer to meet Apple performance standards. Apple is not responsible for the operation of this device or its compliance with safety and regulatory standards. Please note that the use of this accessory with iPod or iPhone may affect wireless performance.
- iPhone, iPod, iPod classic, iPod nano, and iPod touch are trademarks of Apple Inc., registered in the U.S. and other countries.
- iTunes is a trademark of Apple Inc.
-  is a trademark of DVD Format/Logo Licensing Corporation registered in the U.S., Japan and other countries.
- This item incorporates copy protection technology that is protected by U.S. patents and other intellectual property rights of Rovi Corporation. Reverse engineering and disassembly are prohibited.
- Manufactured under license from Dolby Laboratories. Dolby and the double-D symbol are trademarks of Dolby Laboratories.
- Manufactured under license under U.S. Patent Nos: 5,956,674; 5,974,380; 6,487,535 & other U.S. and worldwide patents issued & pending. DTS, the Symbol, & DTS and the Symbol together are registered trademarks & DTS 2.0 Channel is a trademark of DTS, Inc. Product includes software. © DTS, Inc. All Rights Reserved.
- Android is a trademark of Google Inc.
- Adobe, Acrobat and Reader are either registered trademarks or trademarks of Adobe Systems Incorporated in the United States and/or other countries.
- SDHC and microSDHC Logos are trademarks of SD-3C, LLC.
- ABOUT DIVX VIDEO: DivX® is a digital video format created by DivX, LLC, a subsidiary of Rovi Corporation. This is an official DivX Certified® device that plays DivX video. Visit divx.com for more information and software tools to convert your files into DivX videos.
- ABOUT DIVX VIDEO-ON-DEMAND: This DivX Certified® device must be registered in order to play purchased DivX Video-on-Demand (VOD) movies. To obtain your registration code, locate the DivX VOD section in your device setup menu. Go to vod.divx.com for more

information on how to complete your registration.

- DivX®, DivX Certified® and associated logos are trademarks of Rovi Corporation or its subsidiaries and are used under license.

• Requirements Aha™:

Requirements for listening to Aha™ are as follows:

- Download the Aha application from the iTunes App Store or Android Marketplace.
- In the application on your device, log in and create a free account with Aha.
- Internet connection by 3G, EDGE, or WiFi.

iPhone or iPod touch

- Use an Apple iPhone or iPod touch running iOS4 or later.
- Search for "Aha" in the Apple iTunes App Store to find and install the most current version of the Aha™ application on your device.
- iPhone/ iPod touch connected to this unit with a KCA-iP202 or KCA-iP102.

Android™

- Use Android OS 2.2 or later.
- Download the Aha™ application to your smartphone from the Android Marketplace.
- Bluetooth must be built in and the following profiles must be supported.
 - SPP (Serial Port Profile)
 - A2DP (Advanced Audio Distribution Profile)

Note

- Because Aha™ is a third-party service, the specifications are subject to change without prior notice. Accordingly, compatibility may be impaired or some or all of the services may become unavailable.
- Some Aha™ functionality cannot be operated from this unit.
- aha, the Aha logo, and the Aha trade dress are trademarks or registered trademarks of HARMAN International Industries, used with permission.

■ The marking of products using lasers



The label is attached to the chassis/case and says that the component uses laser beams that have been classified as Class 1. It means that the unit is utilizing laser beams that are of a weaker class. There is no danger of hazardous radiation outside the unit.

■ Information on Disposal of Old Electrical and Electronic Equipment and Batteries (applicable for EU countries that have adopted separate waste collection systems)

Products and batteries with the symbol (crossed-out wheeled bin) cannot be disposed as household waste. Old electrical and electronic equipment and batteries should be recycled at a facility capable of handling these items and their waste byproducts.

Contact your local authority for details in locating a recycle facility nearest to you.

Proper recycling and waste disposal will help conserve resources whilst preventing detrimental effects on our health and the environment.

Notice: The sign "Pb" below the symbol for batteries indicates that this battery contains lead.





Declaration of Conformity with regard to the EMC Directive 2004/108/EC

Declaration of Conformity with regard to the R&TTE Directive 1999/5/EC

Manufacturer:

JVC KENWOOD Corporation

3-12, Moriyacho, Kanagawa-ku, Yokohama-shi, Kanagawa 221-0022, JAPAN

EU Representative's:

KENWOOD Electronics Europe BV

Amsterdamseweg 37, 1422 AC UITHOORN, The Netherlands

English

Hereby, JVC KENWOOD declares that this unit DNX7230DAB, DNX5230DAB, DNX5230BT, DNX4230DAB, DNX4230BT is in compliance with the essential requirements and other relevant provisions of Directive 1999/5/EC.

Français

Par la présente JVC KENWOOD déclare que l'appareil DNX7230DAB, DNX5230DAB, DNX5230BT, DNX4230DAB, DNX4230BT est conforme aux exigences essentielles et aux autres dispositions pertinentes de la directive 1999/5/CE.

Par la présente, JVC KENWOOD déclare que ce DNX7230DAB, DNX5230DAB, DNX5230BT, DNX4230DAB, DNX4230BT est conforme aux exigences essentielles et aux autres dispositions de la directive 1999/5/CE qui lui sont applicables.

Deutsch

Hiermit erklärt JVC KENWOOD, dass sich dieser DNX7230DAB, DNX5230DAB, DNX5230BT, DNX4230DAB, DNX4230BT in Übereinstimmung mit den grundlegenden Anforderungen und den anderen relevanten Vorschriften der Richtlinie 1999/5/EG befindet. (BMW)

Hiermit erklärt JVC KENWOOD die Übereinstimmung des Gerätes DNX7230DAB, DNX5230DAB, DNX5230BT, DNX4230DAB, DNX4230BT mit den grundlegenden Anforderungen und den anderen relevanten Festlegungen der Richtlinie 1999/5/EG. (Wien)

Nederlands

Hierbij verklaart JVC KENWOOD dat het toestel DNX7230DAB, DNX5230DAB, DNX5230BT, DNX4230DAB, DNX4230BT in overeenstemming is met de essentiële eisen en de andere relevante bepalingen van richtlijn 1999/5/EG.

Bij deze verklaart JVC KENWOOD dat deze DNX7230DAB, DNX5230DAB, DNX5230BT, DNX4230DAB, DNX4230BT voldoet aan de essentiële eisen en aan de overige relevante bepalingen van Richtlijn 1999/5/EC.

Italiano

Con la presente JVC KENWOOD dichiara che questo DNX7230DAB, DNX5230DAB, DNX5230BT, DNX4230DAB, DNX4230BT è conforme ai requisiti essenziali ed alle altre disposizioni pertinenti stabilite dalla direttiva 1999/5/CE.

Español

Por medio de la presente JVC KENWOOD declara que el DNX7230DAB, DNX5230DAB, DNX5230BT, DNX4230DAB, DNX4230BT cumple con los requisitos esenciales y cualesquiera otras disposiciones aplicables o exigibles de la Directiva 1999/5/CE.

Português

JVC KENWOOD declara que este DNX7230DAB, DNX5230DAB, DNX5230BT, DNX4230DAB, DNX4230BT está conforme com os requisitos essenciais e outras disposições da Directiva 1999/5/CE.

Polska

JVC KENWOOD niniejszym oświadcza, że DNX7230DAB, DNX5230DAB, DNX5230BT, DNX4230DAB, DNX4230BT spełnia zasadnicze wymogi oraz inne istotne postanowienia dyrektywy 1999/5/EC.

Český

JVC KENWOOD tímto prohlašuje, že DNX7230DAB, DNX5230DAB, DNX5230BT, DNX4230DAB, DNX4230BT je ve shodě se základními požadavky a s dalšími příslušnými ustanoveními Nařízení vlády č. 426/2000 Sb.

Magyar

Alulírott, JVC KENWOOD, kijelenti, hogy a jelen DNX7230DAB, DNX5230DAB, DNX5230BT, DNX4230DAB, DNX4230BT megfelel az 1999/5/EC irányelvben meghatározott alapvető követelményeknek és egyéb vonatkozó előírásoknak.

Svenska

Härmed intygar JVC KENWOOD att denna DNX7230DAB, DNX5230DAB, DNX5230BT, DNX4230DAB, DNX4230BT står i överensstämmelse med de väsentliga egenskapskrav och övriga relevanta bestämmelser som framgår av direktiv 1999/5/EG.

Suomi

JVC KENWOOD vakuuttaa täten että DNX7230DAB, DNX5230DAB, DNX5230BT, DNX4230DAB, DNX4230BT tyyppinen laite on direktiivin 1999/5/EY oleellisten vaatimusten ja sitä koskevien direktiivin muiden ehtojen mukainen.

Slovensko

S tem JVC KENWOOD izjavlja, da je ta DNX7230DAB, DNX5230DAB, DNX5230BT, DNX4230DAB, DNX4230BT v skladu z osnovnimi zahtevami in ostalimi ustreznimi predpisi Direktive 1999/5/EC.

Slovensky

Spoločnosť JVC KENWOOD týmto vyhlasuje, že DNX7230DAB, DNX5230DAB, DNX5230BT, DNX4230DAB, DNX4230BT spĺňa základné požiadavky a ďalšie príslušné ustanovenia Direktívy 1999/5/EC.

Dansk

Undertegnede JVC KENWOOD erklærer herved, at følgende udstyr DNX7230DAB, DNX5230DAB, DNX5230BT, DNX4230DAB, DNX4230BT overholder de væsentlige krav og øvrige relevante krav i direktiv 1999/5/EF.

Norsk

JVC KENWOOD erklærer herved at enheten DNX7230DAB, DNX5230DAB, DNX5230BT, DNX4230DAB, DNX4230BT oppfyller grunnleggende krav og andre bestemmelser i direktiv 1999/5/EF.

Ελληνικά

ΜΕ ΤΗΝ ΠΑΡΟΥΣΑ JVC KENWOOD ΔΗΛΩΝΕΙ ΟΤΙ DNX7230DAB, DNX5230DAB, DNX5230BT, DNX4230DAB, DNX4230BT ΣΥΜΜΟΡΦΩΝΕΤΑΙ ΠΡΟΣ ΤΙΣ ΟΥΣΙΩΔΕΙΣ ΑΠΑΙΤΗΣΕΙΣ ΚΑΙ ΤΙΣ ΛΟΙΠΕΣ ΣΧΕΤΙΚΕΣ ΔΙΑΤΑΞΕΙΣ ΤΗΣ ΟΔΗΓΙΑΣ 1999/5/ΕΚ.

Eesti

Sellega kinnitab JVC KENWOOD, et see DNX7230DAB, DNX5230DAB, DNX5230BT, DNX4230DAB, DNX4230BT vastab direktiivi 1999/5/EC põhilistele nõudmistele ja muudele asjakohastele määrustele.

Latviešu

Ar šo, JVC KENWOOD, apstiprina, ka DNX7230DAB, DNX5230DAB, DNX5230BT, DNX4230DAB, DNX4230BT atbilst Direktīvas 1999/5/EK galvenajām prasībām un citiem tās nosacījumiem.

Lietuviškai

Šiuo, JVC KENWOOD, pareiškia, kad šis DNX7230DAB, DNX5230DAB, DNX5230BT, DNX4230DAB, DNX4230BT atitinka pagrindinius Direktyvos 1999/5/EB reikalavimus ir kitas svarbias nuostatas.

Malti

Hawnhekk, JVC KENWOOD, jiddjigara li dan DNX7230DAB, DNX5230DAB, DNX5230BT, DNX4230DAB, DNX4230BT jidkopwida mal-hittigiet essenzjali u ma provvedimenti oħrajn relevanti li hemm fid-Direttiva 1999/5/EC.

Українська

Компанія JVC KENWOOD заявляє, що цей виріб DNX7230DAB, DNX5230DAB, DNX5230BT, DNX4230DAB, DNX4230BT відповідає ключовим вимогам та іншим пов'язаним положенням Директиви 1999/5/EC.

Türkçe

Bu vesileyle JVC KENWOOD, DNX7230DAB, DNX5230DAB, DNX5230BT, DNX4230DAB, DNX4230BT ünitesinin, 1999/5/EC Direktifinin başlıca gereksinimleri ve diğer ilgili hükümleri ile uyumlu olduğunu beyan eder.

KENWOOD