

ADVANCED SMARTRECTIFIER™ CONTROL IC

Features

- Secondary side high speed SR controller
- DCM, CrCM flyback and Resonant half-bridge topologies
- 200 V proprietary IC technology
- Max 500 KHz switching frequency
- Anti-bounce logic and UVLO protection
- 7 A peak turn off drive current
- Micropower start-up & ultra low quiescent current
- 10.7 V gate drive clamp
- 50ns turn-off propagation delay
- Vcc range from 11.3 V to 20 V
- Direct sensing of MOSFET drain voltage
- Enable function synchronized with MOSFET VDS transition
- Cycle by Cycle MOT Check Circuit prevents multiple false trigger GATE pulses
- Lead-free
- Compatible with 0.3 W Standby, Energy Star, CECP, etc.

Typical Applications

- LCD & PDP TV, Telecom SMPS, AC-DC adapters, ATX SMPS, Server SMPS

Product Summary

Topology	Flyback, Resonant Half-bridge
VD	200 V
V _{OUT}	10.7 V
I _{o+} & I _{o-} (typ.)	+2 A & -7 A
Turn on Propagation Delay (typ.)	60 ns
Turn off Propagation Delay (typ.)	50 ns

Package Options

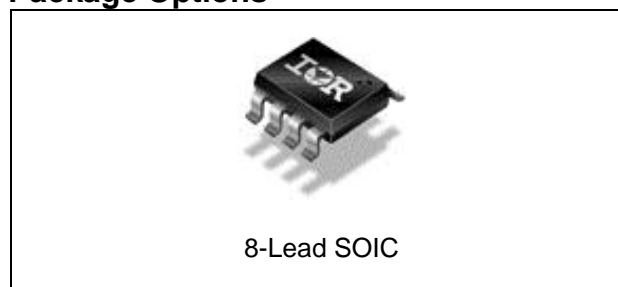

Ordering Information

Base Part Number	Package Type	Standard Pack		Complete Part Number
		Form	Quantity	
IR11672AS	SOIC8N	Tube/Bulk	95	IR11672ASPBF
		Tape and Reel	2500	IR11672ASTRPBF

Typical Connection Diagram

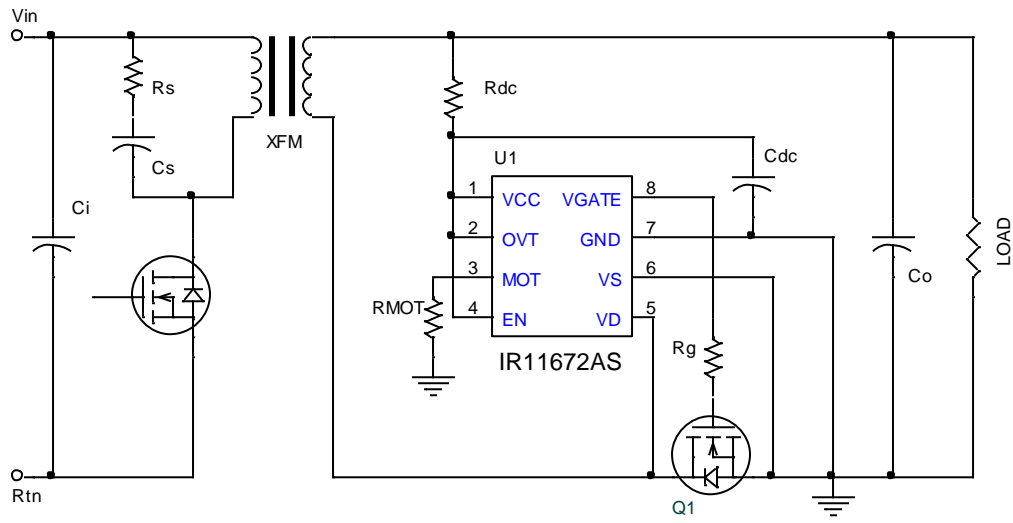

Table of Contents	Page
Ordering Information	1
Description	4
Absolute Maximum Ratings	5
Electrical Characteristics	6
Functional Block Diagram	8
Input / Output Pin Equivalent Circuit Diagram	9
Lead Definitions	10
Lead Assignments	10
Detailed Pin Description	11
Application Information and Additional Details	12
Package Details	23
Tape and Reel Details	24
Part Marking Information	25
Qualification Information	26

Description

IR11672A is a smart secondary-side driver IC designed to drive N-Channel power MOSFETs used as synchronous rectifiers in isolated Flyback and resonant half-bridge converters. The IC can control one or more paralleled N-MOSFETs to emulate the behavior of Schottky diode rectifiers. The drain to source voltage is sensed differentially to determine the polarity of the current and turn the power switch on and off in proximity of the zero current transition. The cycle-by-cycle MOT protection circuit can automatically detect no load condition and turn off gate driver output to avoid negative current flowing through the MOSFETs. Ruggedness and noise immunity are accomplished using an advanced blanking scheme and double-pulse suppression which allow reliable operation in all operating modes.

Absolute Maximum Ratings

Absolute maximum ratings indicate sustained limits beyond which damage to the device may occur. All voltage parameters are absolute voltages referenced to COM, all currents are defined positive into any lead. The thermal resistance and power dissipation ratings are measured under board mounted and still air conditions.

Parameters	Symbol	Min.	Max.	Units	Remarks
Supply Voltage	V_{CC}	-0.3	20	V	
Enable Voltage	V_{EN}	-0.3	20		
Cont. Drain Sense Voltage	V_D	-3	200		
Pulse Drain Sense Voltage	V_D	-5	200		
Source Sense Voltage	V_S	-3	20		
Gate Voltage	V_{GATE}	-0.3	20		$V_{CC}=20V$, Gate off
Operating Junction Temperature	T_J	-40	150	°C	
Storage Temperature	T_S	-55	150		
Thermal Resistance	$R_{\theta JA}$		128	°C/W	SOIC-8
Package Power Dissipation	P_D		970	mW	SOIC-8, $T_{AMB}=25^{\circ}C$
Switching Frequency	fsw		500	kHz	

Recommended Operating Conditions

For proper operation the device should be used within the recommended conditions.

Symbol	Definition	Min.	Max.	Units
V_{CC}	Supply voltage	11.4	18	V
V_D	Drain Sense Voltage	-3	200	
T_J	Junction Temperature	-25	125	°C
Fsw	Switching Frequency	---	500	kHz

Recommended Component Values

Symbol	Component	Min.	Max.	Units
R_{MOT}	MOT pin resistor value	5	75	k Ω

Electrical Characteristics

$V_{CC}=15\text{ V}$ and $T_A = 25\text{ }^\circ\text{C}$ unless otherwise specified. The output voltage and current (V_O and I_O) parameters are referenced to GND (pin7).

Supply Section

Parameters	Symbol	Min.	Typ.	Max.	Units	Remarks
Supply Voltage Operating Range	V_{CC}	11.4		18	V	GBD
V_{CC} Turn On Threshold	$V_{CC\ ON}$	9.8	10.55	11.3		
V_{CC} Turn Off Threshold (Under Voltage Lock Out)	$V_{CC\ UVLO}$	8.4	9	9.7		
V_{CC} Turn On/Off Hysteresis	$V_{CC\ HYST}$		1.55			
Operating Current	I_{CC}		8.5	10	mA	$C_{LOAD}=1\text{nF}, f_{SW}=400\text{kHz}$
			50	65		$C_{LOAD}=10\text{nF}, f_{SW}=400\text{kHz}$
Quiescent Current	I_{QCC}		1.8	2.2	μA	$V_{CC}=V_{CC\ ON} - 0.1\text{V}$ $V_{EN}=0\text{V}, V_{CC}=15\text{V}$
Start-up Current	$I_{CC\ START}$		100	200		
Sleep Current	I_{SLEEP}		150	200		
Enable Voltage High	V_{ENHI}	2.15	2.70	3.2	V	
Enable Voltage Low	V_{ENLO}	1.2	1.6	2.0		
Enable Pull-up Resistance	R_{EN}		1.5		$\text{M}\Omega$	GBD

Comparator Section

Parameters	Symbol	Min.	Typ.	Max.	Units	Remarks
Turn-off Threshold	V_{TH1}	-7	-3.5	0	mV	$OVT = 0\text{V}, V_S=0\text{V}$
		-14	-9.5	-6		$OVT\ \text{floating}, V_S=0\text{V}$
		-22	-18	-14		$OVT = V_{CC}, V_S=0\text{V}$
Turn-on Threshold	V_{TH2}	-150		-50		
Hysteresis	V_{HYST}		55			
Input Bias Current	I_{BIAS1}		1	7.5	μA	$V_D = -50\text{mV}$
	I_{BIAS2}		30	100		$V_D = 200\text{V}$
Comparator Input Offset	V_{OFFSET}			2	mV	GBD
Input CM Voltage Range	V_{CM}	-0.15		2	V	

One-Shot Section

Parameters	Symbol	Min.	Typ.	Max.	Units	Remarks
Blanking pulse duration	t_{BLANK}	9	17	25	μs	
Reset Threshold	V_{TH3}		2.5		V	$V_{CC}=10\text{V} - \text{GBD}$
			5.4			$V_{CC}=20\text{V} - \text{GBD}$
Hysteresis	V_{HYST3}		40		mV	$V_{CC}=10\text{V} - \text{GBD}$

Electrical Characteristics

$V_{CC}=15\text{ V}$ and $T_A = 25\text{ }^\circ\text{C}$ unless otherwise specified. The output voltage and current (V_O and I_O) parameters are referenced to GND (pin7).

Minimum On Time Section

Parameters	Symbol	Min.	Typ.	Max.	Units	Remarks
Minimum on time	T_{ONmin}	190	240	290	ns	$R_{MOT}=5k\Omega, V_{CC}=12V$
		2.48	3.1	3.72	μs	$R_{MOT}=75k\Omega, V_{CC}=12V$

Gate Driver Section

Parameters	Symbol	Min.	Typ.	Max.	Units	Remarks
Gate Low Voltage	V_{GLO}		0.3	0.5	V	$I_{GATE} = 200mA$
Gate High Voltage	V_{GTH}	9.0	10.7	12.5		$V_{CC}=12V-18V$ (internally clamped)
Rise Time	t_{r1}		18		ns	$C_{LOAD} = 1nF, V_{CC}=12V$
	t_{r2}		125			$C_{LOAD} = 10nF, V_{CC}=12V$
Fall Time	t_{f1}		10			$C_{LOAD} = 1nF, V_{CC}=12V$
	t_{f2}		30			$C_{LOAD} = 10nF, V_{CC}=12V$
Turn on Propagation Delay	t_{Don}		60	95		V_{DS} to V_{GATE} -100mV overdrive
Turn off Propagation Delay	t_{Doff}		50	75		V_{DS} to V_{GATE} -100mV overdrive
Pull up Resistance	r_{up}		4		Ω	$I_{GATE} = 1A - GBD$
Pull down Resistance	r_{down}		0.7			$I_{GATE} = -200mA$
Output Peak Current(source)	$I_{O\ source}$		2		A	$C_{LOAD} = 10nF - GBD$
Output Peak Current (sink)	$I_{O\ sink}$		7			

Functional Block Diagram

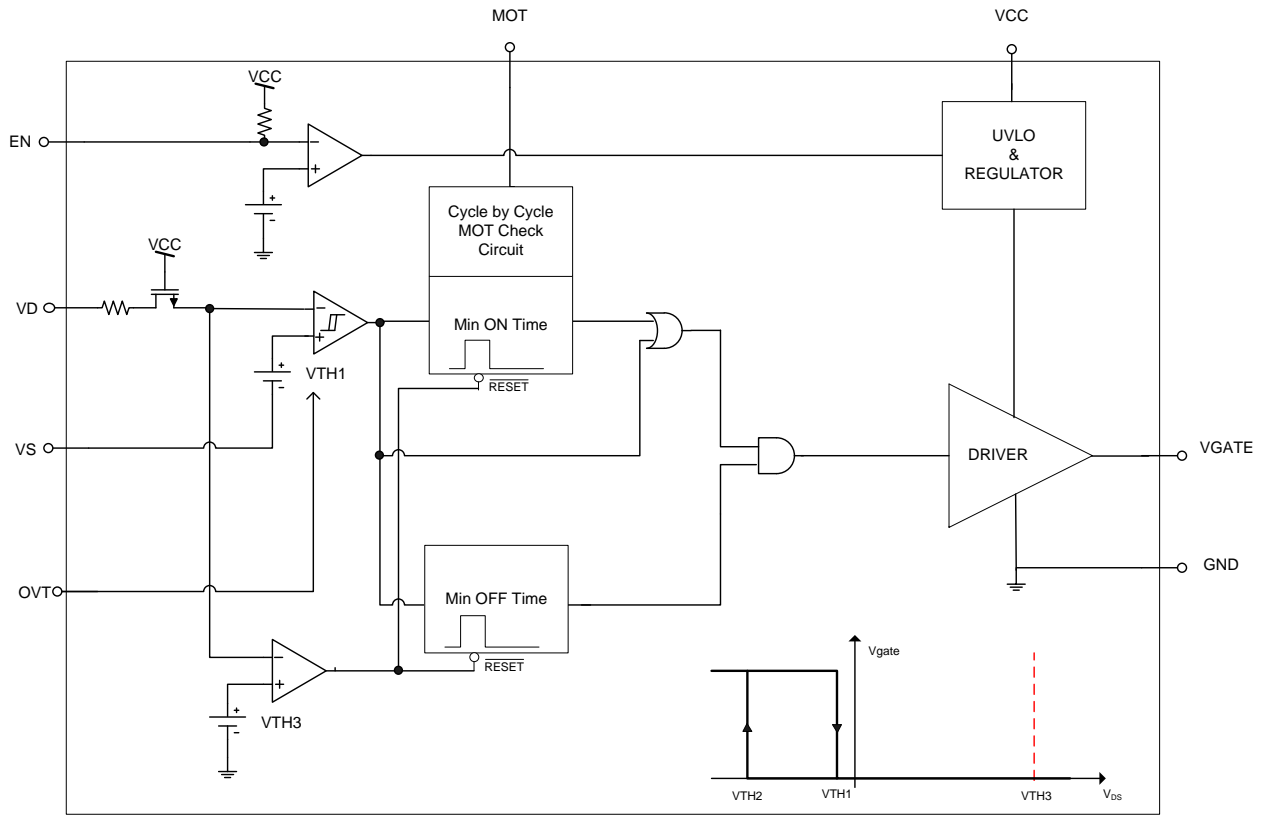

I/O Pin Equivalent Circuit Diagram

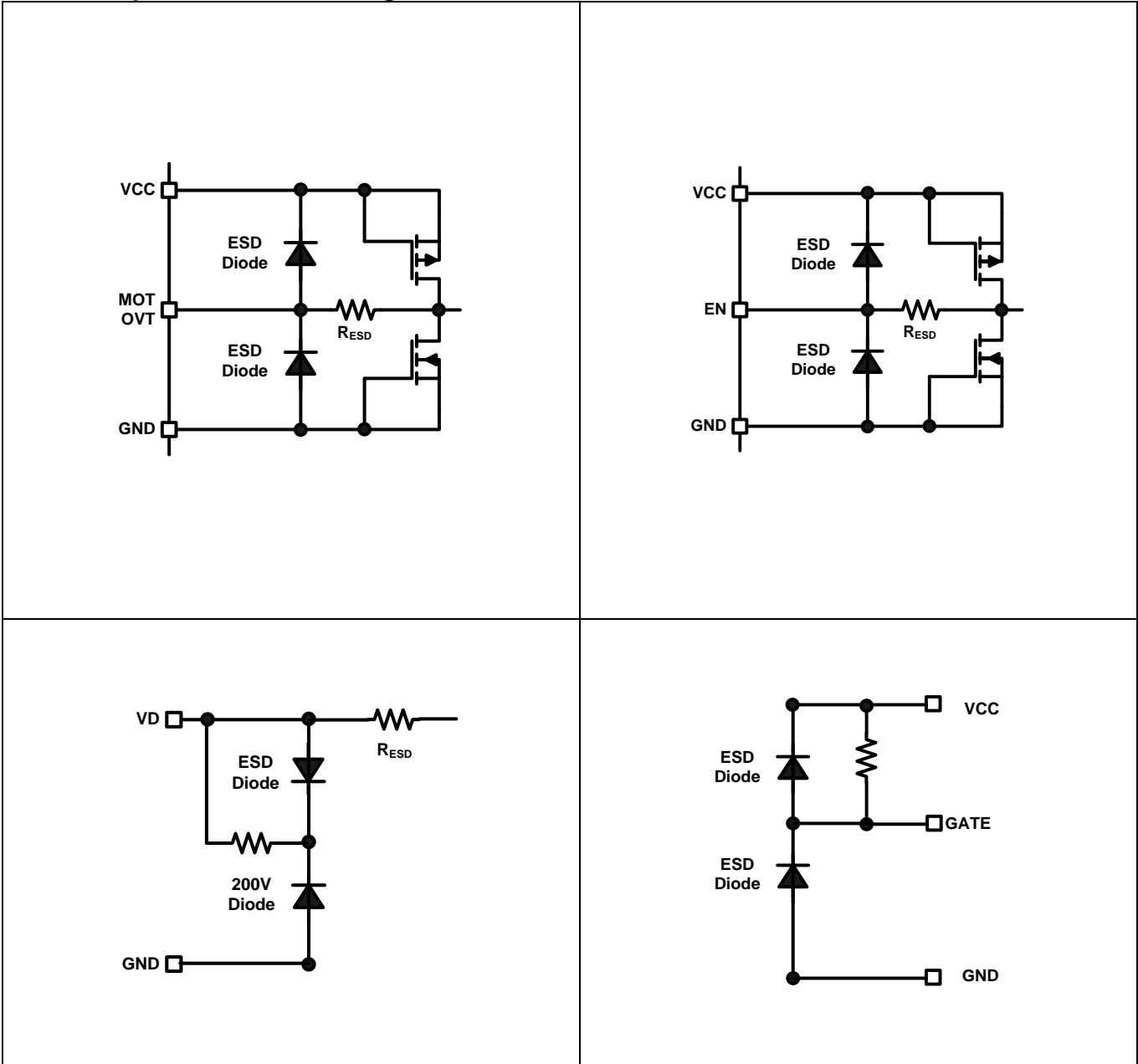

Lead Definitions

PIN#	Symbol	Description
1	VCC	Supply Voltage
2	OVT	Offset Voltage Trimming
3	MOT	Minimum On Time
4	EN	Enable
5	VD	FET Drain Sensing
6	VS	FET Source Sensing
7	GND	Ground
8	VGATE	Gate Drive Output

Lead Assignments

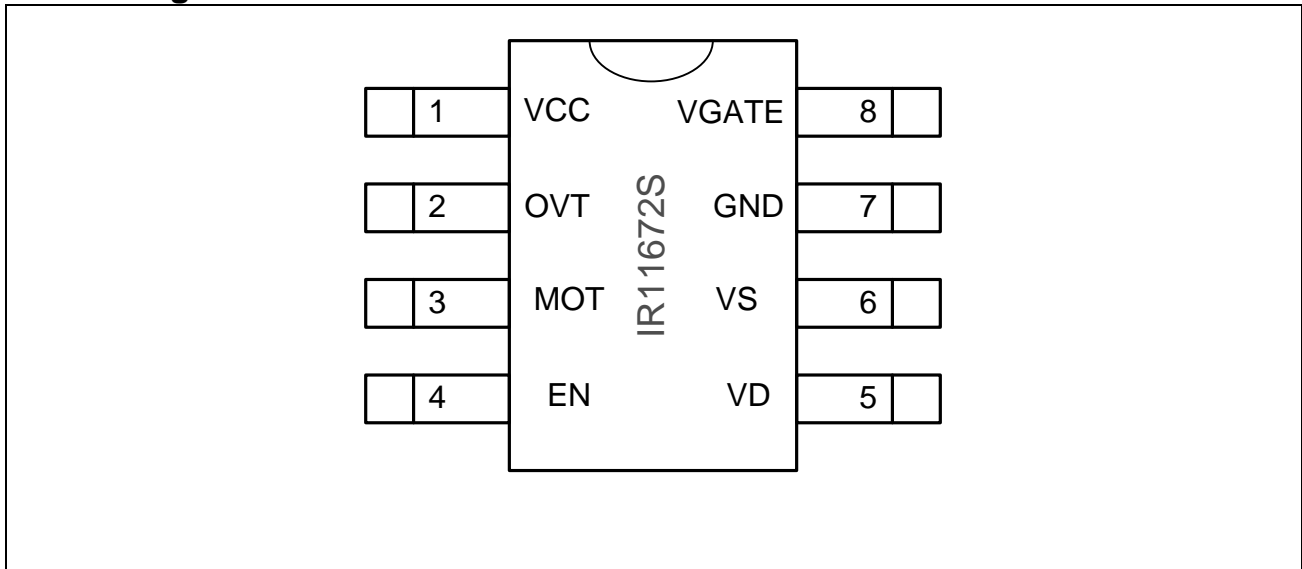

Detailed Pin Description

VCC: Power Supply

This is the supply voltage pin of the IC and it is monitored by the under voltage lockout circuit. It is possible to turn off the IC by pulling this pin below the minimum turn off threshold voltage, without damage to the IC.

To prevent noise problems, a bypass ceramic capacitor connected to Vcc and COM should be placed as close as possible to the IR11672A. This pin is internally clamped.

OVT: Offset Voltage Trimming

The OVT pin will program the amount of input offset voltage for the turn-off threshold V_{TH1} .

The pin can be optionally tied to ground, to VCC or left floating, to select 3 ranges of input offset trimming.

This programming feature allows for accommodating different R_{DSon} MOSFETs.

MOT: Minimum On Time

The MOT programming pin controls the amount of minimum on time. Once V_{TH2} is crossed for the first time, the gate signal will become active and turn on the power FET. Spurious ringings and oscillations can trigger the input comparator off. The MOT blanks the input comparator keeping the FET on for a minimum time.

The MOT is programmed between 200ns and 3 μ s (typ.) by using a resistor referenced to COM.

EN: Enable

This pin is used to activate the IC "sleep" mode by pulling the voltage level below 1.6V (typ). In sleep mode the IC will consume a minimum amount of current. All switching functions will be disabled and the gate will be inactive. The EN pin voltage cannot linger between the Enable low and Enable high thresholds. The pin is intended to operate as a switch with the pin voltage either above or below the threshold range. The Enable control pin (EN) is not intended to operate at high frequency. For proper operation, EN positive pulse width needs to be longer than 20 μ s, EN negative pulse width needs to be longer than 10 μ s. Please refer to Figure 12B for the definition of EN pulse width.

VD: Drain Voltage Sense

VD is the voltage sense pin for the power MOSFET Drain. This is a high voltage pin and particular care must be taken in properly routing the connection to the power MOSFET drain.

Additional filtering and or current limiting on this pin are not recommended as it would limit switching performance of the IC.

VS: Source Voltage Sense

VS is the differential sense pin for the power MOSFET Source. This pin must not be connected directly to the power ground pin (7) but must be used to create a Kelvin contact as close as possible to the power MOSFET source pin.

GND: Ground

This is ground potential pin of the integrated control circuit. The internal devices and gate driver are referenced to this point.

VGATE: Gate Drive Output

This is the gate drive output of the IC. Drive voltage is internally limited and provides 2A peak source and 7A peak sink capability. Although this pin can be directly connected to the power MOSFET gate, the use of minimal gate resistor is recommended, especially when putting multiple FETs in parallel.

Care must be taken in order to keep the gate loop as short and as small as possible in order to achieve optimal switching performance.

Application Information and Additional Details

State Diagram

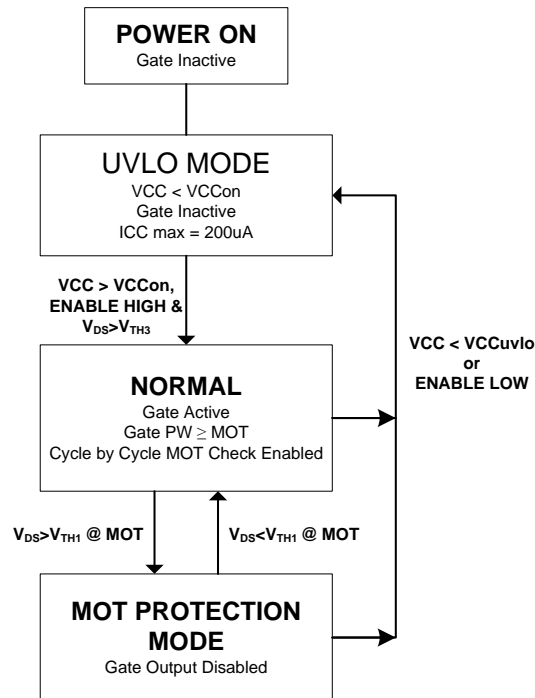

UVLO/Sleep Mode

The IC remains in the UVLO condition until the voltage on the VCC pin exceeds the VCC turn on threshold voltage, $V_{CC\ ON}$. During the time the IC remains in the UVLO state, the gate drive circuit is inactive and the IC draws a quiescent current of $I_{CC\ START}$. The UVLO mode is accessible from any other state of operation whenever the IC supply voltage condition of $V_{CC} < V_{CC\ UVLO}$ occurs.

The sleep mode is initiated by pulling the EN pin below 1.6V (typ). In this mode the IC is essentially shut down and draws a very low quiescent supply current.

Normal Mode and Synchronized Enable Function

The IC enters in normal operating mode once the UVLO voltage has been exceeded and the EN voltage is above V_{ENHI} threshold. When the IC enters the Normal Mode from the UVLO Mode, the GATE output is disabled (stays low) until V_{DS} exceeds V_{TH3} to activate the gate. This ensures that the GATE output is not enabled in the middle of a switching cycle. This logic prevents any reverse currents across the device due to the minimum on time function in the IC. The gate will continuously drive the SR MOSFET after this one-time activation. The Cycle by Cycle MOT protection circuit is enabled in Normal Mode.

MOT Protection Mode

If the secondary current conduction time is shorter than the MOT (Minimum On Time) setting, the next driver output is disabled. This function can avoid reverse current that occurs when the system works at very low duty-cycles or at very light/no load conditions and reduce system standby power consumption by disabling GATE outputs. The Cycle by Cycle MOT Check circuit is always activated under Normal Mode and MOT Protection Mode, so that the IC can automatically resume normal operation once the load increases to a level and the secondary current conduction time is longer than MOT.

General Description

The IR11672A Smart Rectifier IC can emulate the operation of diode rectifier by properly driving a Synchronous Rectifier (SR) MOSFET. The direction of the rectified current is sensed by the input comparator using the power MOSFET $R_{DS(on)}$ as a shunt resistance and the GATE pin of the MOSFET is driven accordingly. Internal blanking logic is used to prevent spurious transitions and guarantee operation in continuous (CCM), discontinuous (DCM) and critical (CrCM) conduction mode.

IR11672A is suitable for Flyback and Resonant Half-Bridge topologies.

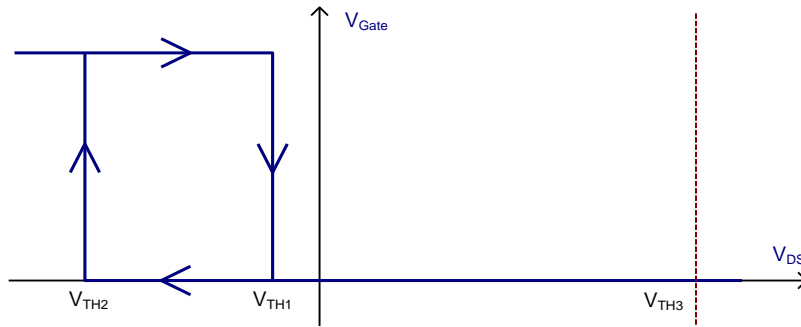

Figure 1: Input comparator thresholds

Flyback Application

The modes of operation for a Flyback circuit differ mainly for the turn-off phase of the SR switch, while the turn-on phase of the secondary switch (which corresponds to the turn off of the primary side switch) is identical.

Turn-on phase

When the conduction phase of the SR FET is initiated, current will start flowing through its body diode, generating a negative V_{DS} voltage across it. The body diode has generally a much higher voltage drop than the one caused by the MOSFET on resistance and therefore will trigger the turn-on threshold V_{TH2} .

At that point the IR11672A will drive the gate of MOSFET on which will in turn cause the conduction voltage V_{DS} to drop down. This drop is usually accompanied by some amount of ringing, that can trigger the input comparator to turn off; hence, a Minimum On Time (MOT) blanking period is used that will maintain the power MOSFET on for a minimum amount of time.

The programmed MOT will limit also the minimum duty cycle of the SR MOSFET and, as a consequence, the max duty cycle of the primary side switch.

DCM/CrCM Turn-off phase

Once the SR MOSFET has been turned on, it will remain on until the rectified current will decay to the level where V_{DS} will cross the turn-off threshold V_{TH1} . This will happen differently depending on the mode of operation.

In DCM the current will cross the threshold with a relatively low di/dt . Once the threshold is crossed, the current will start flowing again thru the body diode, causing the V_{DS} voltage to jump negative. Depending on the amount of residual current, V_{DS} may trigger once again the turn on threshold: for this reason V_{TH2} is blanked for a certain amount of time (T_{BLANK}) after V_{TH1} has been triggered.

The blanking time is internally set. As soon as V_{DS} crosses the positive threshold V_{TH3} also the blanking time is terminated and the IC is ready for next conduction cycle.

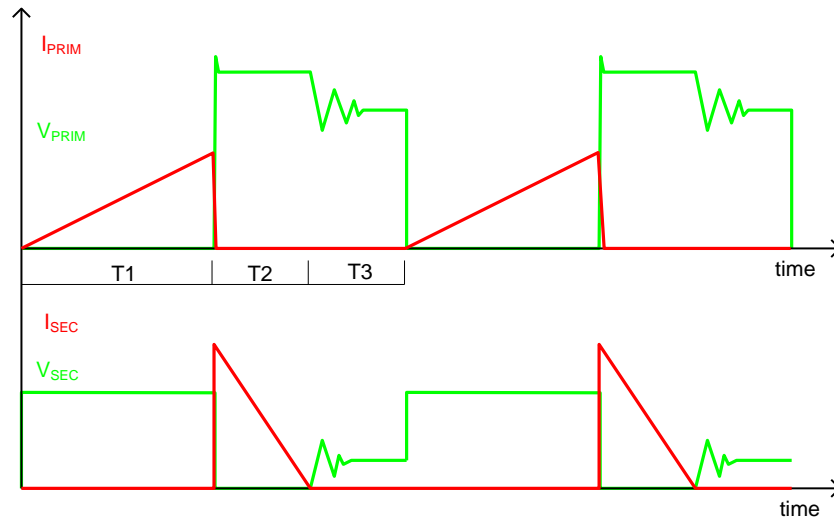
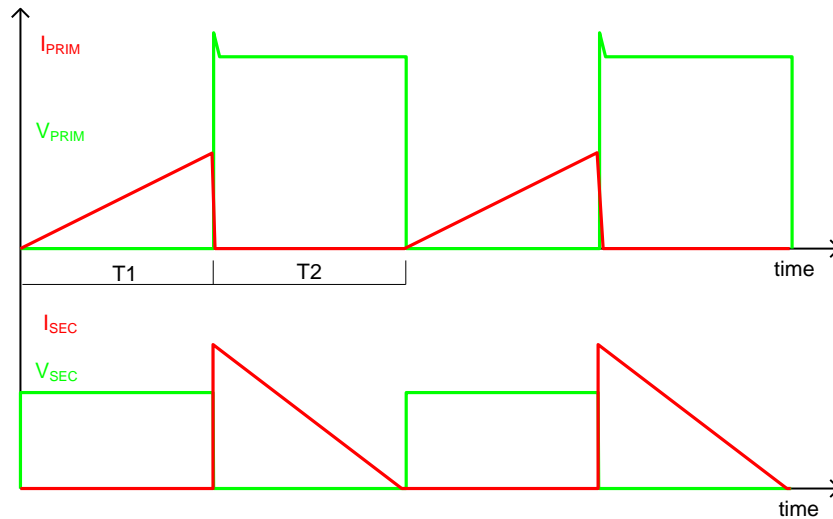
Figure 2: Primary and secondary currents and voltages for DCM mode

Figure 3: Primary and secondary currents and voltages for CrCM mode
CCM Turn-off phase

In CCM mode the turn off transition is much steeper and di/dt involved is much higher. The turn on phase is identical to DCM or CrCM and therefore won't be repeated here.

During the SR FET conduction phase the current will decay linearly, and so will V_{DS} on the SR FET.

Once the primary switch will start to turn back on, the SR FET current will rapidly decrease crossing V_{TH1} and turning the gate off. The turn off speed is critical to avoid cross conduction on the primary side and reduce switching losses.

Also in this case a blanking period will be applied, but given the very fast nature of this transition, it will be reset as soon as V_{DS} crosses V_{TH3} .

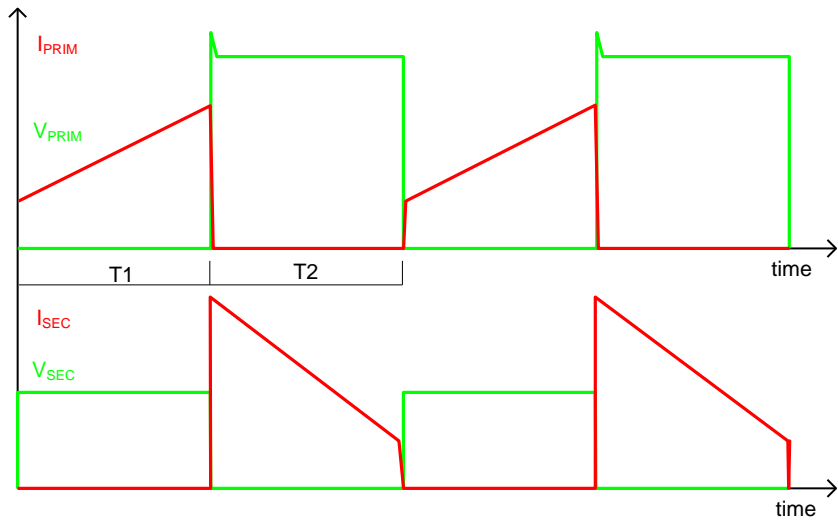

Figure 4: Primary and secondary currents and voltages for CCM mode

The operation waveforms of IR11672A in a flyback converter under CCM mode and DCM/CrCM were shown in Figure 5 and Figure 6 respectively.

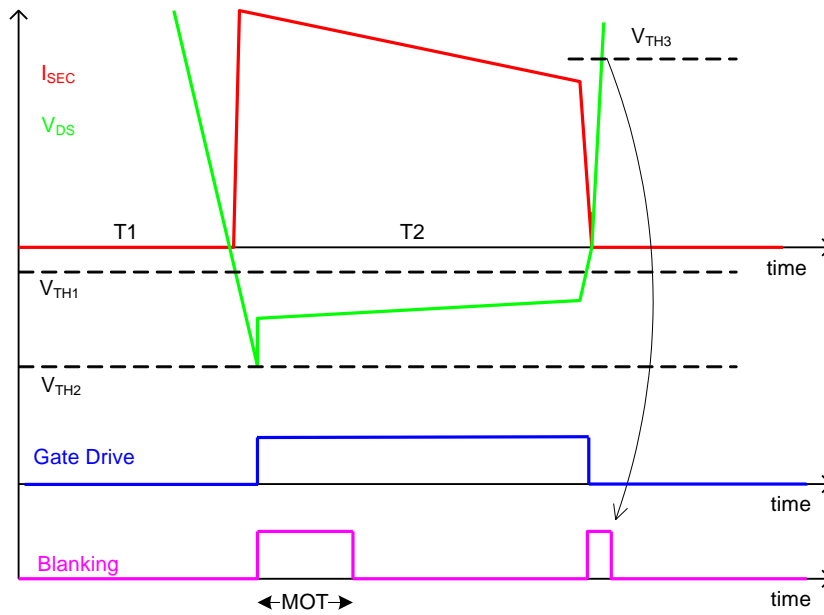

Figure 5: Secondary side CCM operation

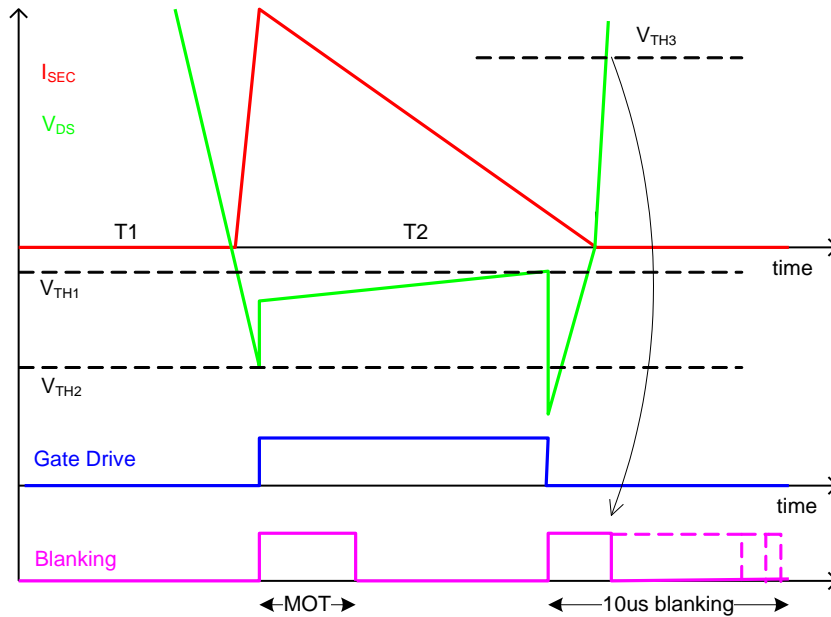

Figure 6: Secondary side DCM/CrCM operation

Resonant Half-Bridge Application

The typical application circuit of IR11672A in LLC half-bridge is shown in Figure 7.

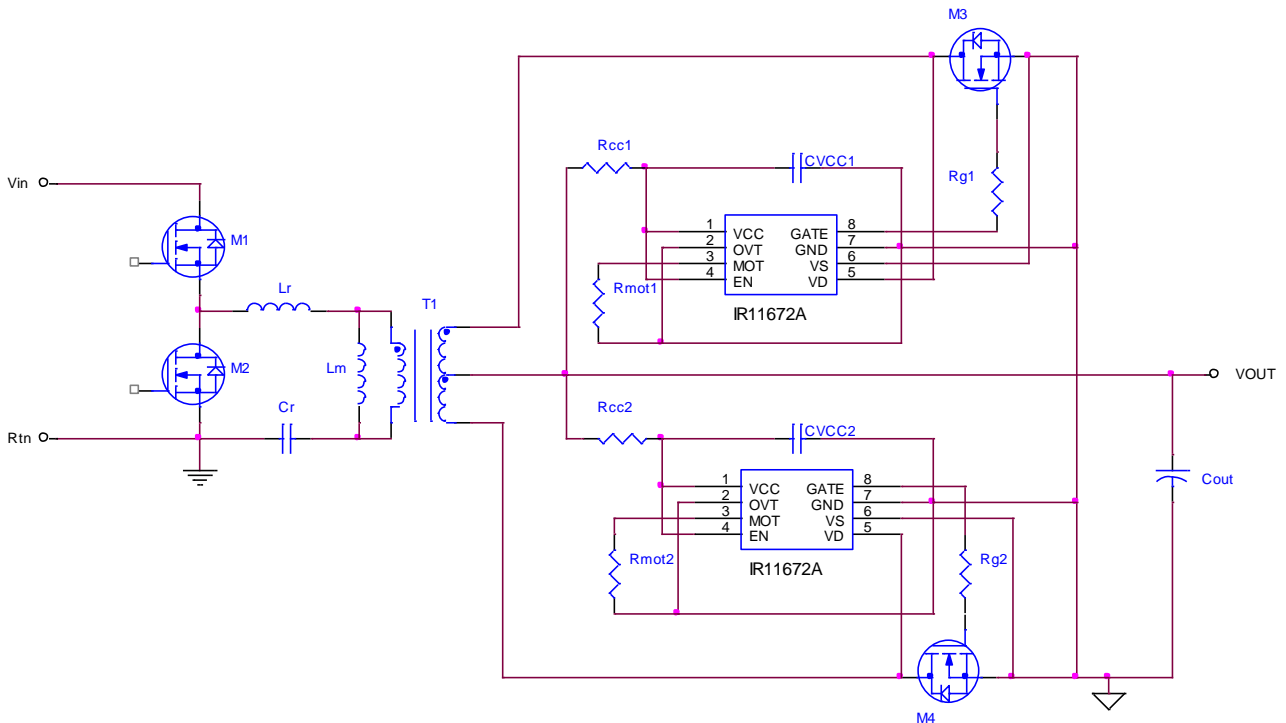

Figure 7: Resonant half-bridge application circuit

In resonant half-bridge converter, the turn-on phase and turn-off phase is similar to flyback except the current shape is sinusoid. The typical operation waveform can be found below.

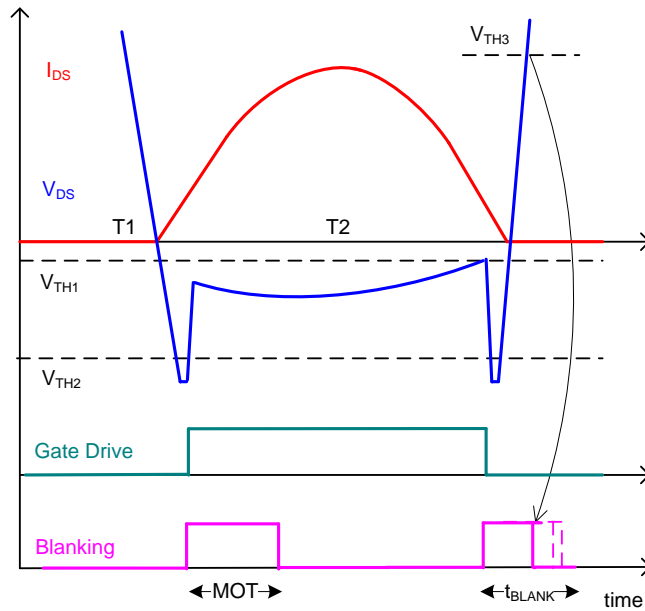

Figure 8: Resonant half-bridge operation waveform

MOT Protection Mode

The MOT protection prevents reverse current in SR MOSFET which could happen at light load if the MOT time is set very long. The IC disables the gate output in the protection mode and automatically resume to normal operation as the load increasing to a level where the SR current conduction time is longer than MOT.

This function works in both flyback and resonant half-bridge topologies. Figure 9 is an example in Flyback converter.

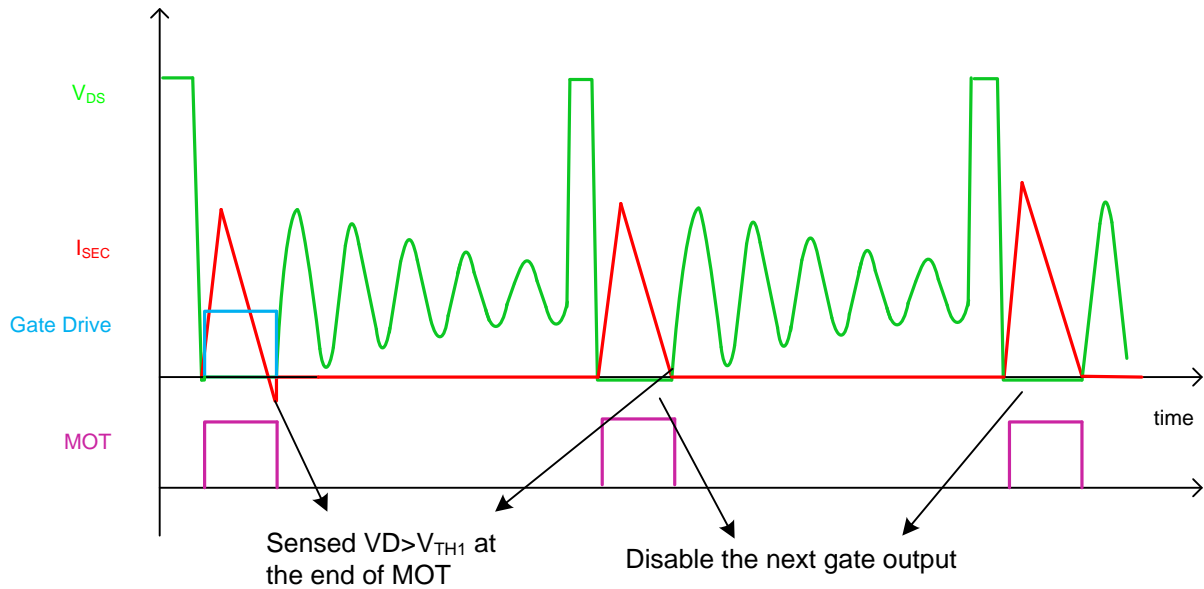

Figure 9: MOT Protection Mode

Synchronized Enable Function

Sync Enable function guarantees the VGATE always starts switching at the beginning of a switching cycle. This function works in both flyback and resonant half-bridge topologies. Figure 10 is an example in resonant half-bridge converter.

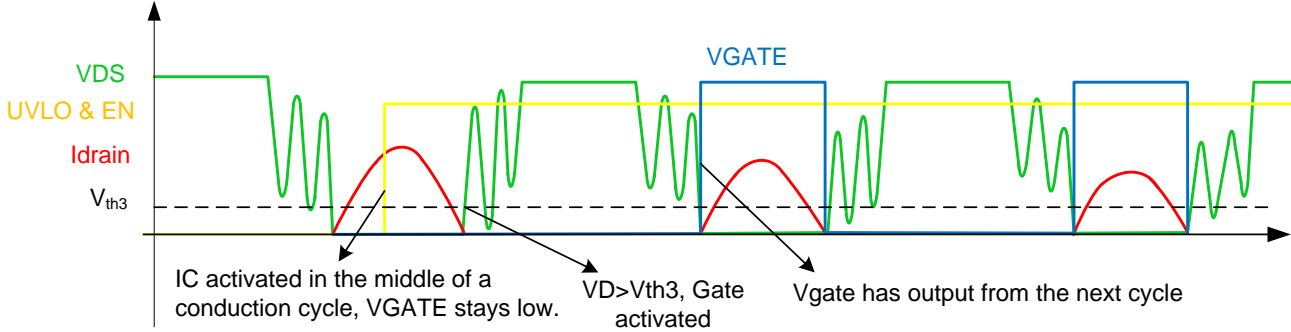

Figure 10: Synchronized Enable Function (resonant half-bridge)

General Timing Waveform

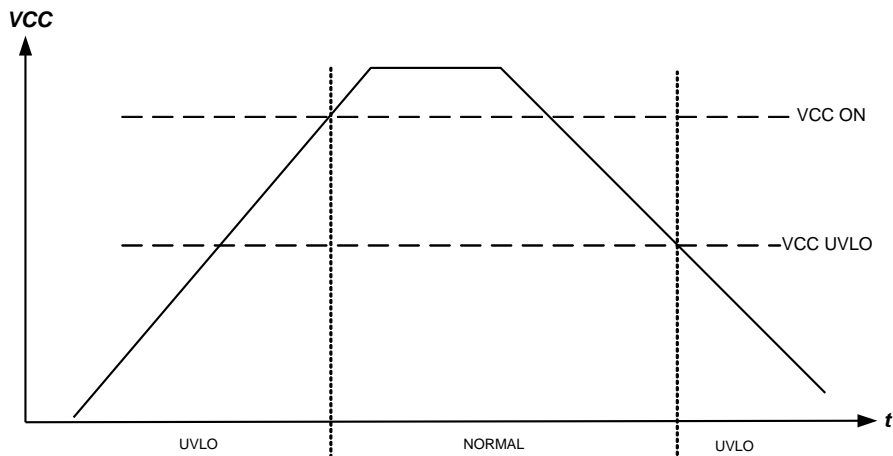

Figure 11: Vcc UVLO

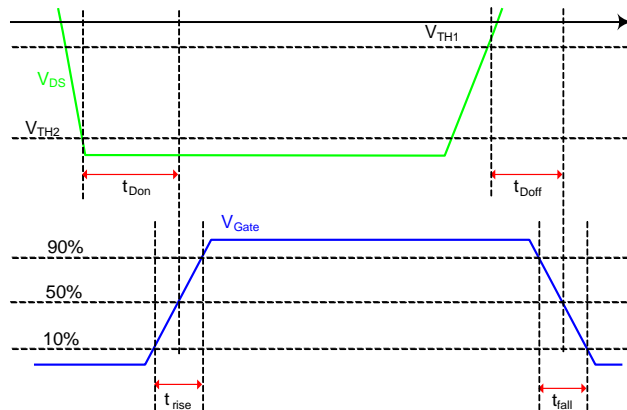

Figure 12A: Timing waveform

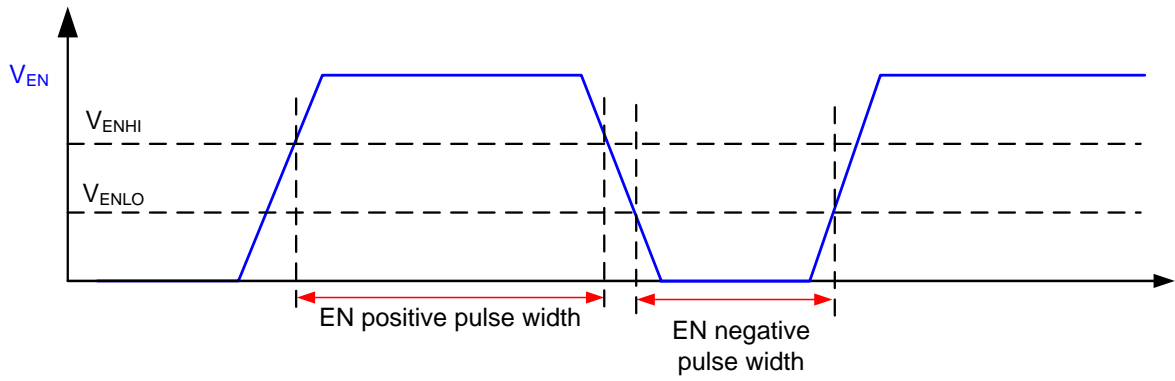
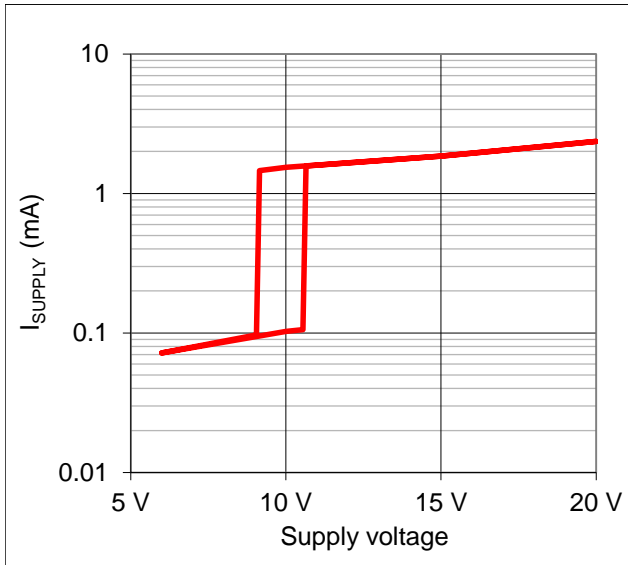
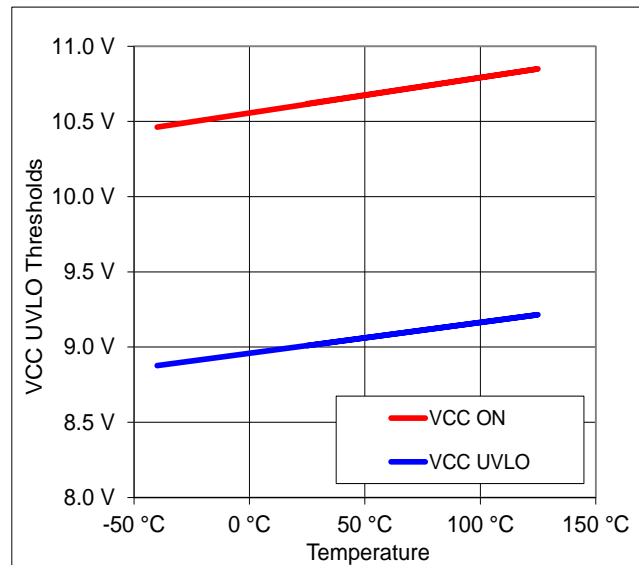
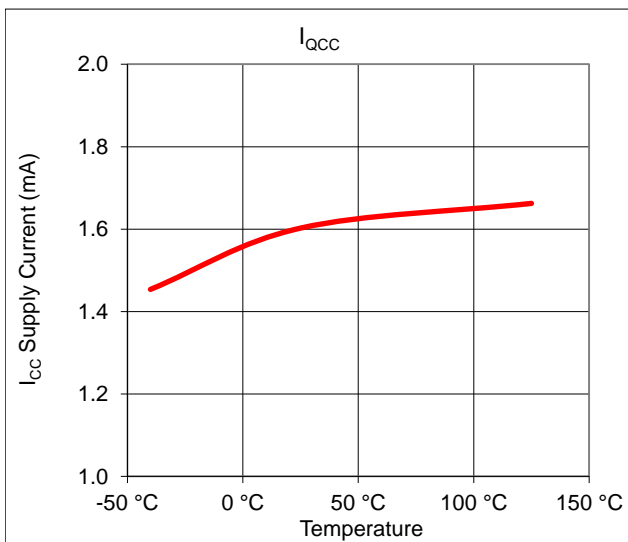
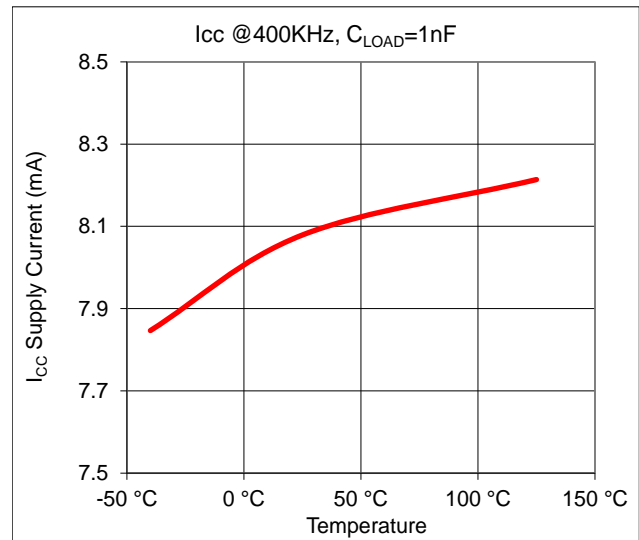

Figure 12B: Enable timing waveform

Figure 13: Supply Current vs. Supply Voltage

Figure 14: Undervoltage Lockout vs. Temperature

Figure 15: Icc Quiescent Current vs. Temperature

Figure 16: Icc Supply Current @1nF Load vs. Temperature

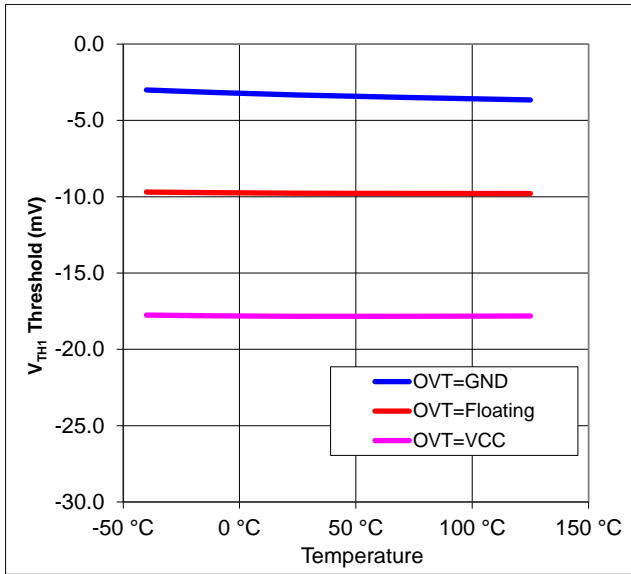

Figure 17: V_{TH1} vs. Temperature

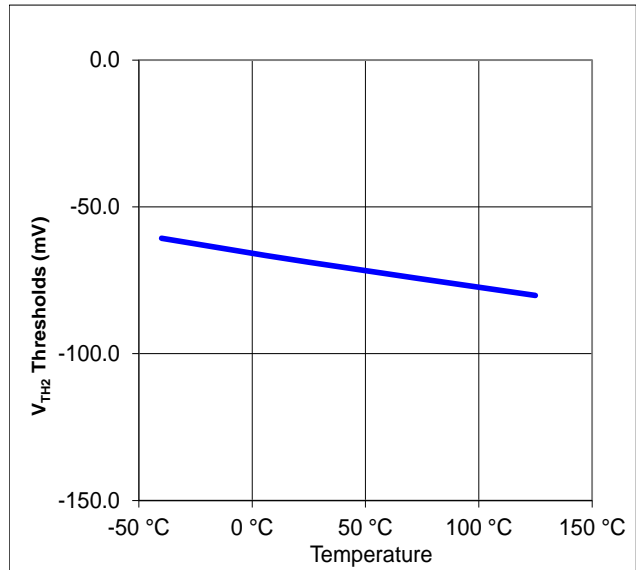

Figure 18: V_{TH2} vs. Temperature

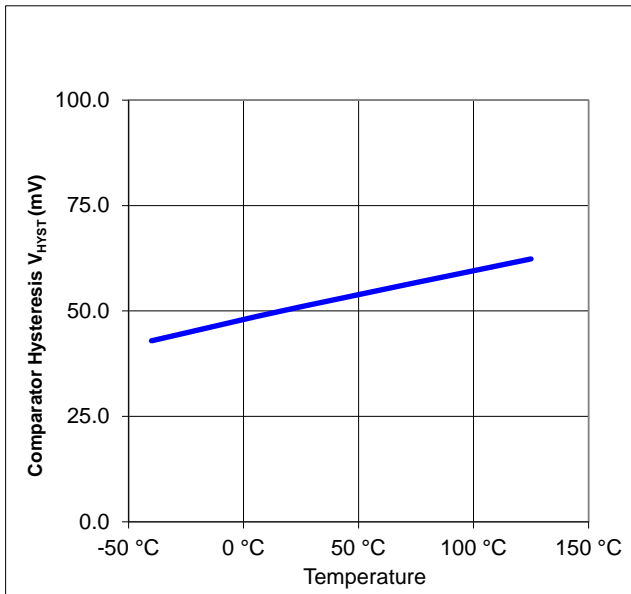

Figure 19: Comparator Hysteresis vs. Temperature

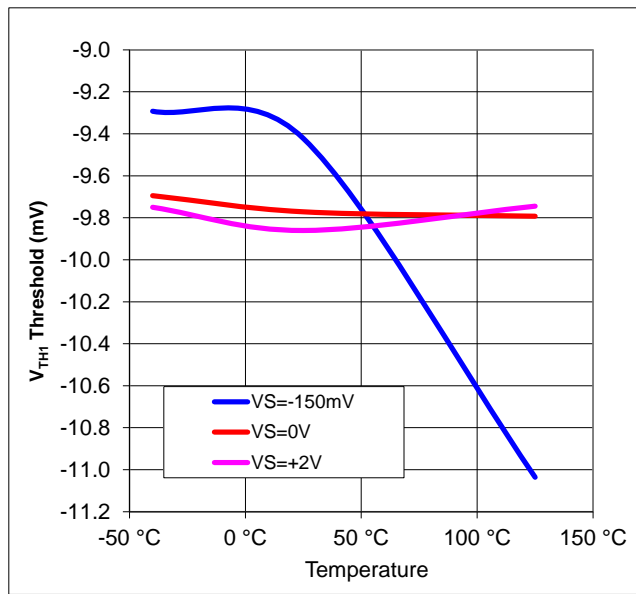

Figure 20: V_{TH1} vs. Temperature and Common Mode (OVT=Floating)

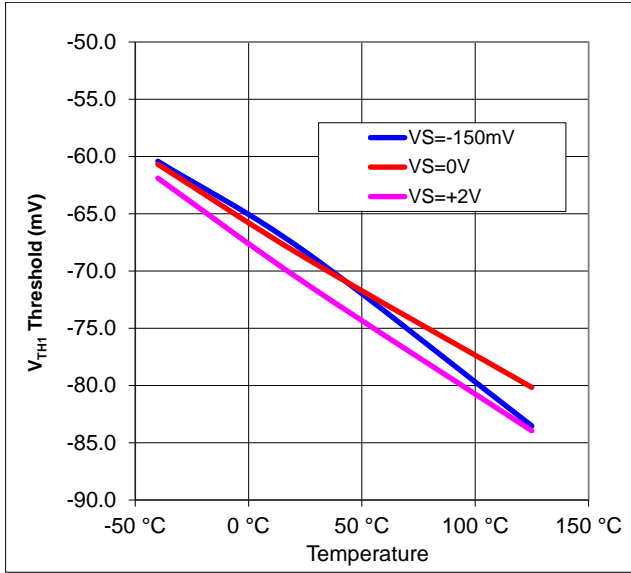

Figure 21: V_{TH2} vs. Temperature and Common Mode

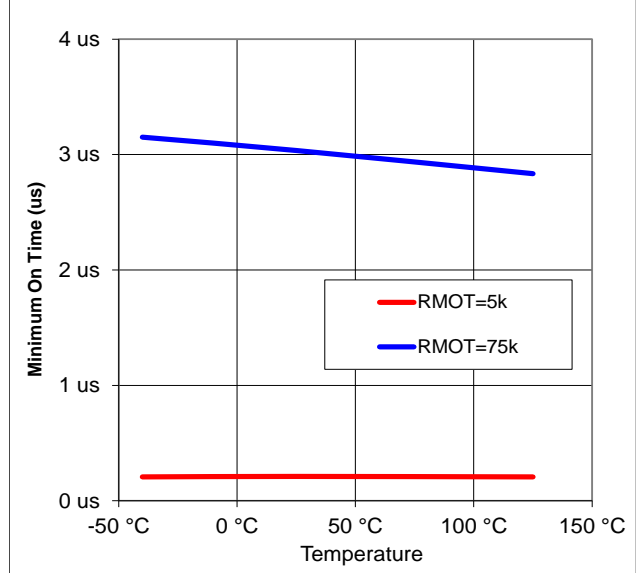

Figure 22: MOT vs Temperature

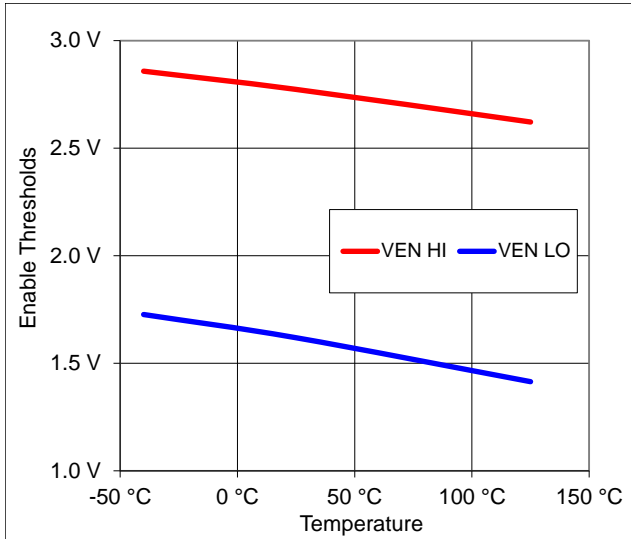

Figure 23: Enable Threshold vs. Temperature

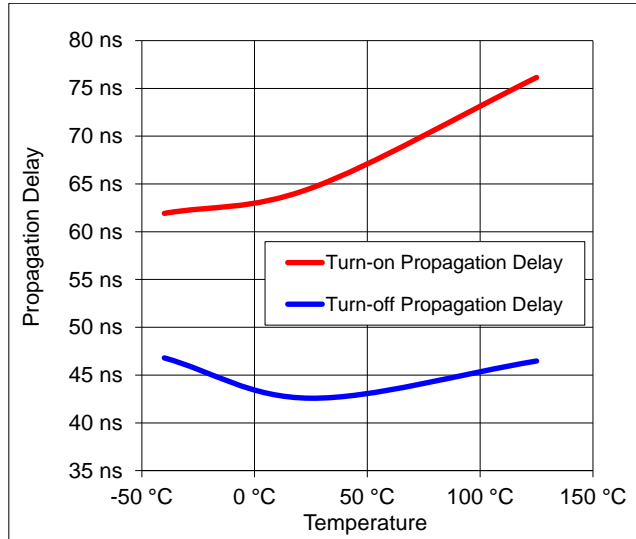
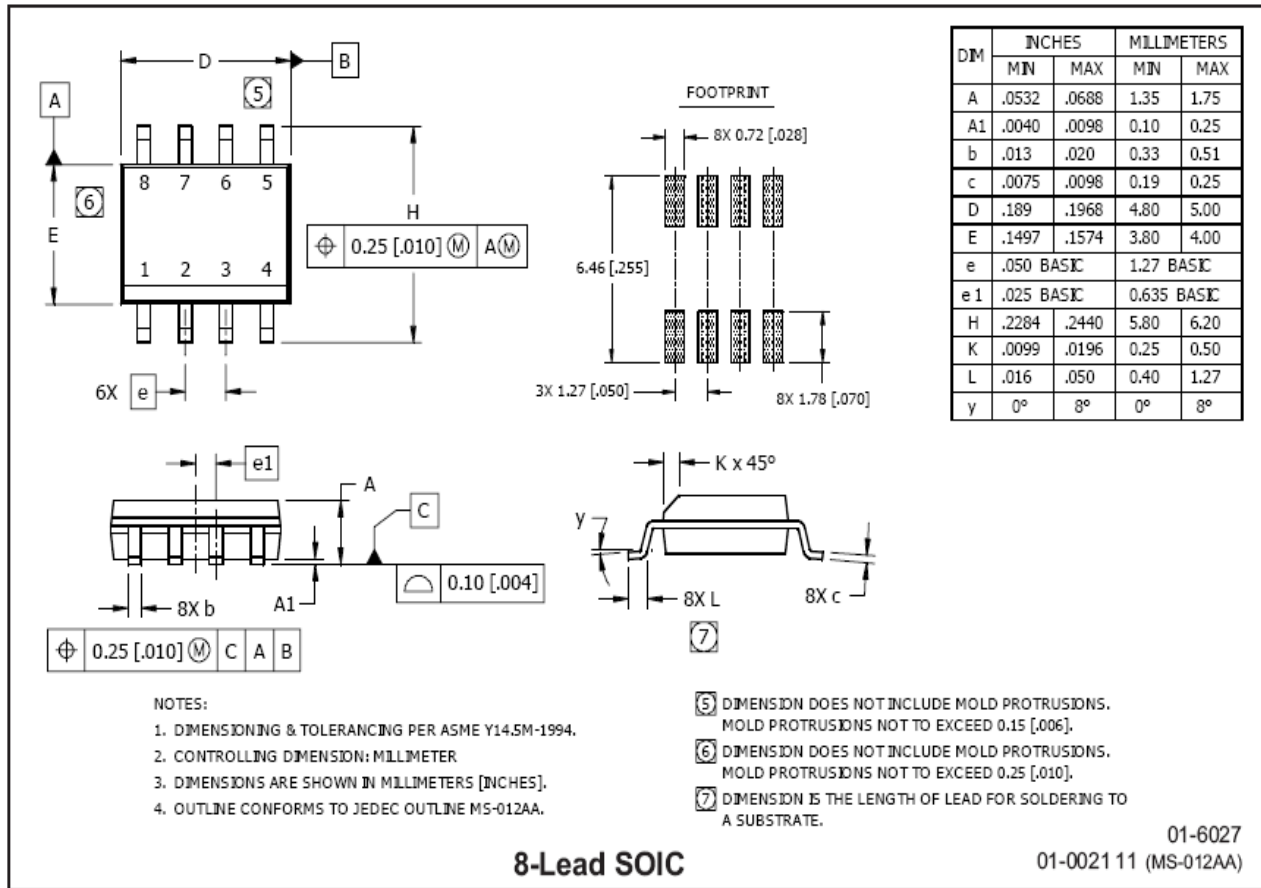
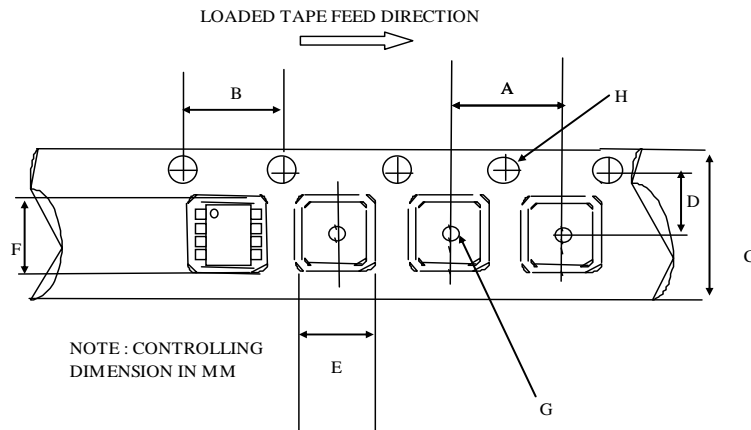

Figure 24: Turn-on and Turn-off Propagation Delay vs. Temperature

Package Details: SOIC8N



Tape and Reel Details: SOIC8N

CARRIER TAPE DIMENSION FOR 8SOICN

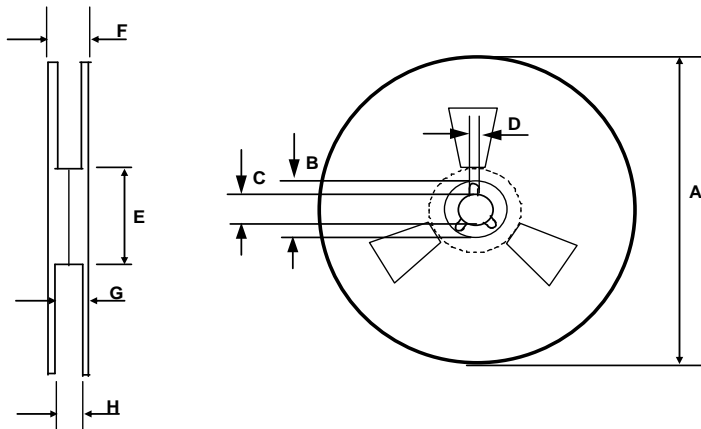
Code	Metric		Imperial	
	Min	Max	Min	Max
A	7.90	8.10	0.311	0.318
B	3.90	4.10	0.153	0.161
C	11.70	12.30	0.46	0.484
D	5.45	5.55	0.214	0.218
E	6.30	6.50	0.248	0.255
F	5.10	5.30	0.200	0.208
G	1.50	n/a	0.059	n/a
H	1.50	1.60	0.059	0.062

REEL DIMENSIONS FOR 8SOICN

Code	Metric		Imperial	
	Min	Max	Min	Max
A	329.60	330.25	12.976	13.001
B	20.95	21.45	0.824	0.844
C	12.80	13.20	0.503	0.519
D	1.95	2.45	0.767	0.096
E	98.00	102.00	3.858	4.015
F	n/a	18.40	n/a	0.724
G	14.50	17.10	0.570	0.673
H	12.40	14.40	0.488	0.566

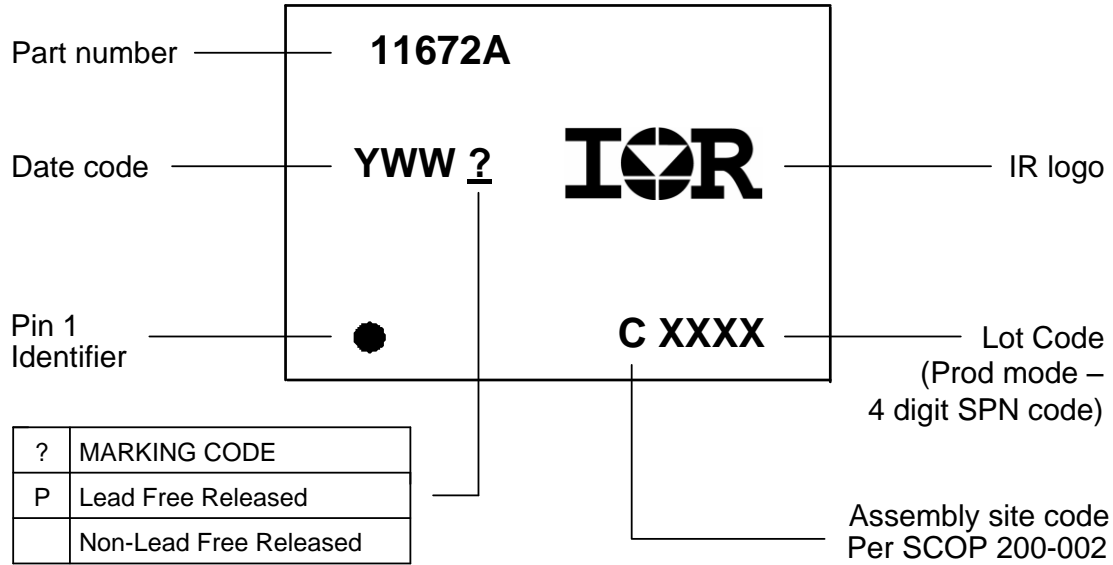
Part Marking Information



Qualification Information[†]

Qualification Level		Industrial ^{††}
		Comments: This family of ICs has passed JEDEC's Industrial qualification. IR's Consumer qualification level is granted by extension of the higher Industrial level.
Moisture Sensitivity Level		MSL2 ^{†††} 260°C (per IPC/JEDEC J-STD-020)
ESD	Machine Model	Class B (per JEDEC standard JESD22-A115)
	Human Body Model	Class 2 (per EIA/JEDEC standard EIA/JESD22-A114)
IC Latch-Up Test		Class I, Level A (per JESD78)
RoHS Compliant		Yes

† Qualification standards can be found at International Rectifier's web site <http://www.irf.com/>

†† Higher qualification ratings may be available should the user have such requirements. Please contact your International Rectifier sales representative for further information.

††† Higher MSL ratings may be available for the specific package types listed here. Please contact your International Rectifier sales representative for further information.

The information provided in this document is believed to be accurate and reliable. However, International Rectifier assumes no responsibility for the consequences of the use of this information. International Rectifier assumes no responsibility for any infringement of patents or of other rights of third parties which may result from the use of this information. No license is granted by implication or otherwise under any patent or patent rights of International Rectifier. The specifications mentioned in this document are subject to change without notice. This document supersedes and replaces all information previously supplied.

For technical support, please contact IR's Technical Assistance Center
<http://www.irf.com/technical-info/>

WORLD HEADQUARTERS:
 233 Kansas St., El Segundo, California 90245
 Tel: (310) 252-7105