

# SGL-06SMT2

Low Noise Amplifier  
5MHz to 4000MHz

RFMD's SGL-06SMT2 is a low noise, high gain MMIC LNA designed for low power, single supply operation from 2.7V to 3.6V. It's Class-1C ESD protection ensures rugged performance, while its integrated active bias circuit provides stable gain over temperature. SGL-06SMT2 is internally matched from 5MHz to 4000MHz and requires minimal external components. The SGL-06SMT2 die is fabricated using highly repeatable Silicon Germanium technology and is packaged in a hermetic SMT2 package.



Package: SMT2, 4-pin, 11.42mm x 11.42mm x 4.32mm

## Features

- 27dB Gain at 1.575GHz
- 1.4dB Noise Figure at 1.575GHz
- Single 3.3V Supply Operation
- Integrated Active Bias Circuit
- Hermetic Package
- MIL-STD-883 Screening

## Applications

- GPS Receivers
- Military and Industrial

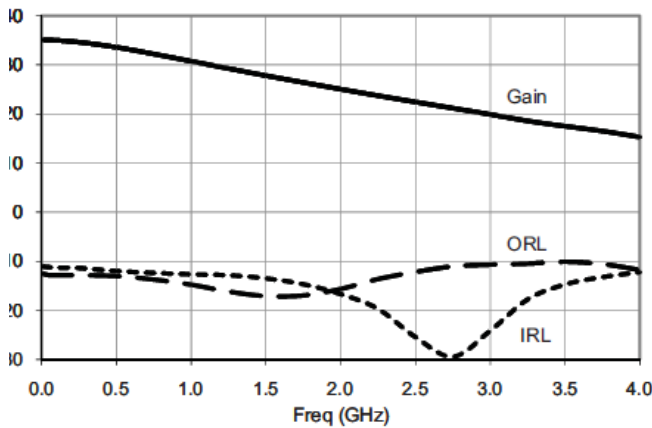

Functional Block Diagram

## Ordering Information

SGL-06SMT2 .005GHz to 4GHz LNA, SMT-2 package

## Absolute Maximum Ratings

Parameter	Rating	Unit
Device Current ( $I_D$ )	30	mA
Device Voltage ( $V_D$ )	4	V
RF Input Power (See Note)	-10	dBm
Junction Temperature ( $T_J$ )	+150	W
Operating Temperature Range ( $T_O$ )	-40 to +85	°C
Storage Temperature Range	-65 to +150	°C
ESD Rating - Human Body Model (HBM)	Class 1C	



**Caution!** ESD sensitive device.

Exceeding any one or a combination of the Absolute Maximum Rating conditions may cause permanent damage to the device. Extended application of Absolute Maximum Rating conditions to the device may reduce device reliability. Specified typical performance or functional operation of the device under Absolute Maximum Rating conditions is not implied.

\*Note: Survival Rating.  $Z_{LOAD} = 50\Omega$ . Max recommended input power for continuous operation: -20dBm.

## Nominal Operating Parameters

Parameter	Specification			Unit	Condition
	Min	Typ	Max		
<b>General Performance</b>					
Device Operating Current	7.5	10.0	12.5	mA	
Small Signal Gain	32.0	35.0	38.0	dB	5MHz
	24.0	27.0	30.0	dB	1.575GHz
	14.0	17.0	20.0	dB	3.55GHz
Input Return Loss		-13.5	-9.5	dB	1.575GHz
Output Return Loss		-17.0	-9.5	dB	1.575GHz
Output Power at 1dB Compression	3.3	5.5		dB	1.575GHz
Noise Figure		1.4	1.9	dBm	1.575GHz
Thermal Resistance		173		°C/W	Junction to Case

Parameter	Unit	10MHz	100MHz	450MHz	850MHz	1.575GHz	1.95GHz	2.44GHz	3.55GHz
Small Signal Gain	dB	35.0	34.9	33.7	31.5	27.0	25.3	22.7	17.0
Input Return Loss	dB	-11.2	-11.3	-11.8	-12.4	-13.5	-15.9	-23.5	-14.1
Output Return Loss	dB	-12.6	-12.8	-12.9	-14.1	-17.0	-15.9	-12.5	-10.0
Reverse Isolation	dB	-40.1	-40.0	-40.2	f	-39.0	-37.1	-35.0	-32.0
Output Power at 1dB Compression	dBm	9.5	9.4	10.1	8.4	5.5	4.9	3.6	0.6
Noise Figure	dB	1.1	1.0	1.0	1.1	1.4	1.6	-	-

Typical Performance: 50Ω Test Fixture with Bias Tees,  $V_S = 3.3V$ ,  $I_D = 10.0mA$

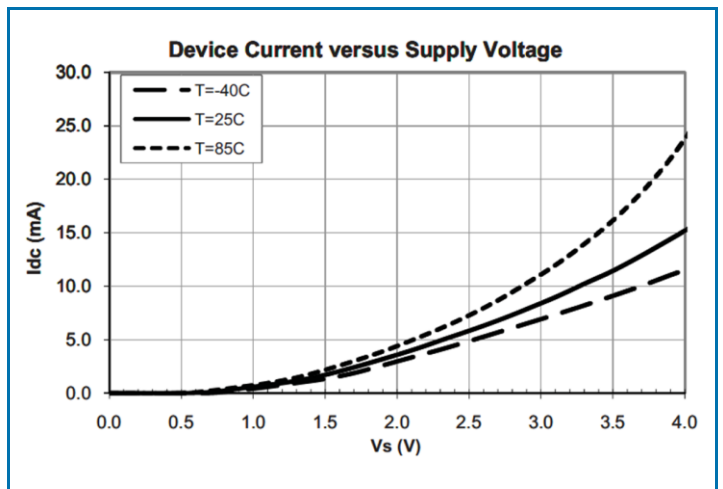
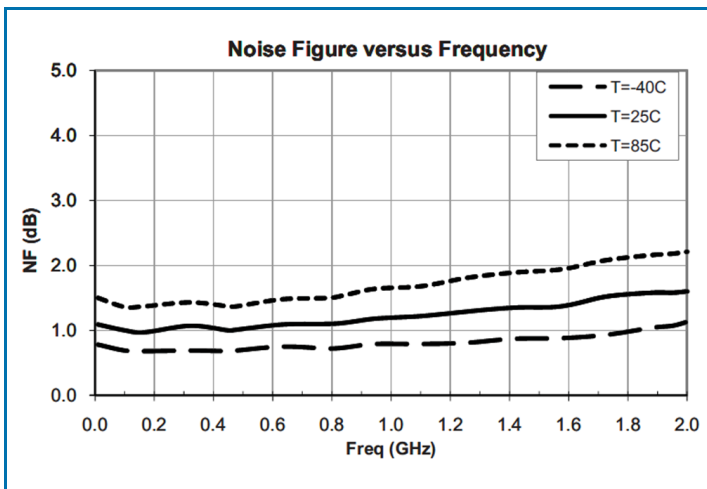
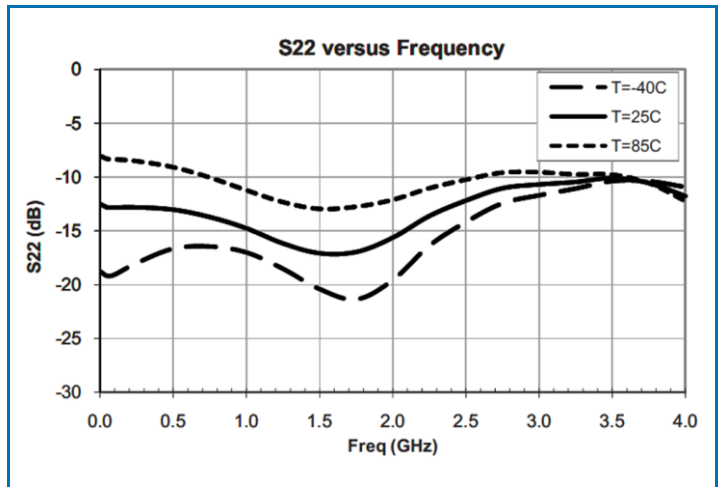
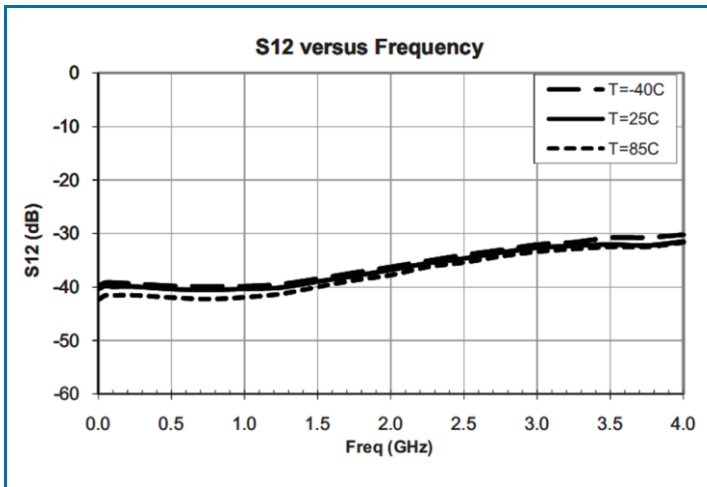
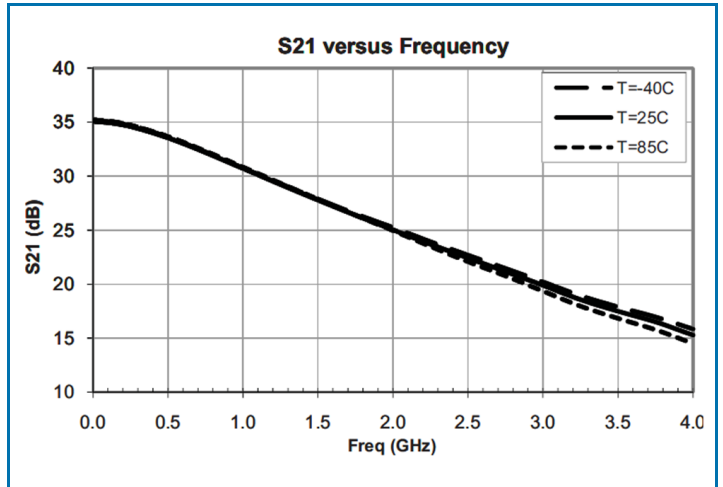
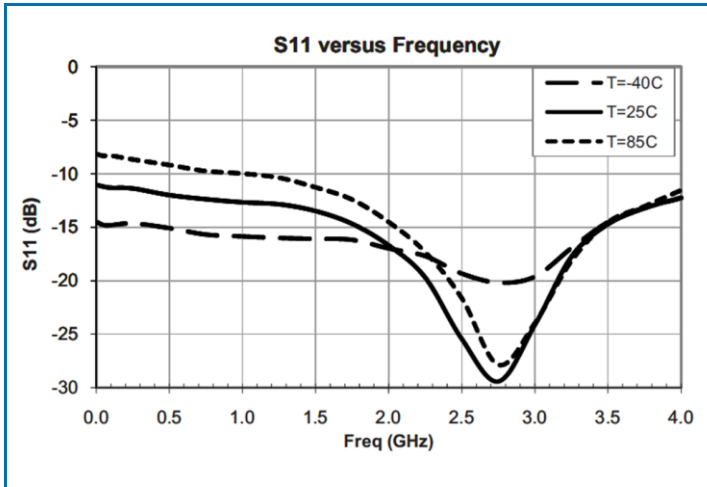

Typical Performance: 100MHz to 4GHz Application Circuit,  $V_S = 3.3V$ ,  $I_D = 10.0mA$

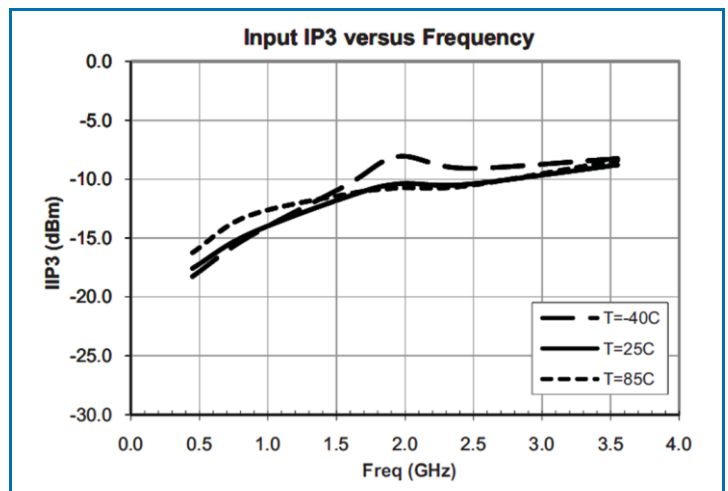
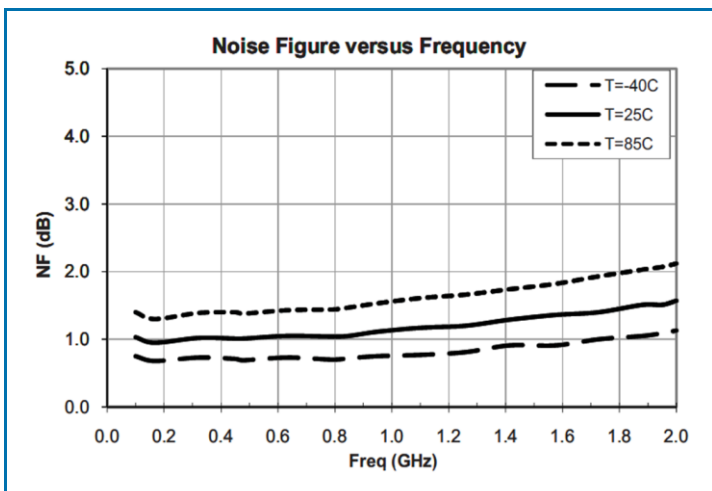
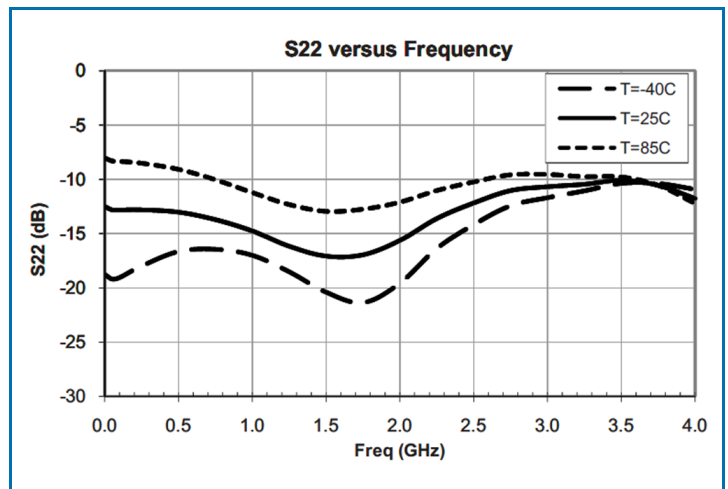
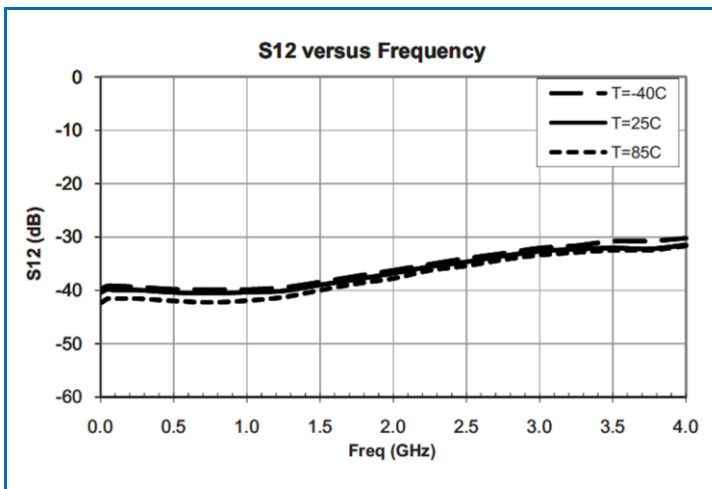
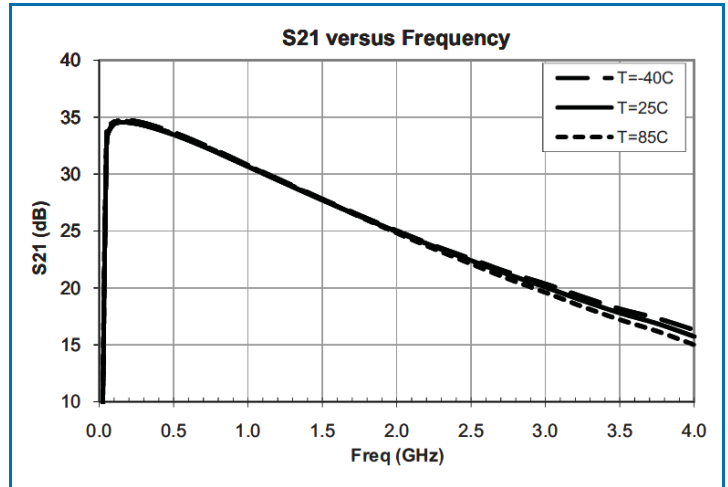
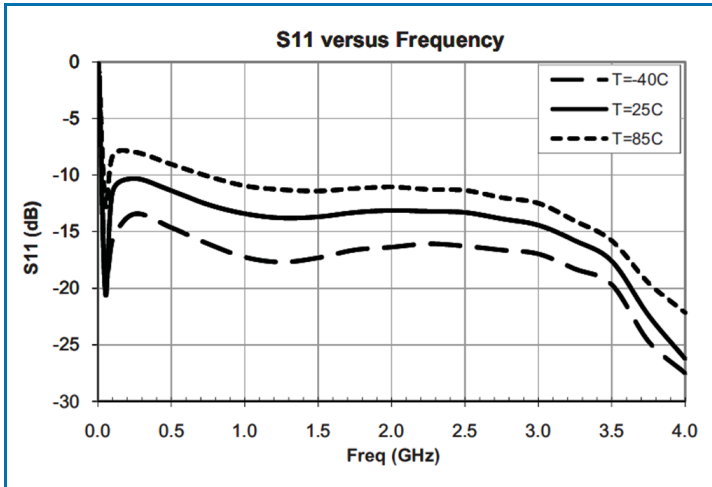

SMT2 Package Outline

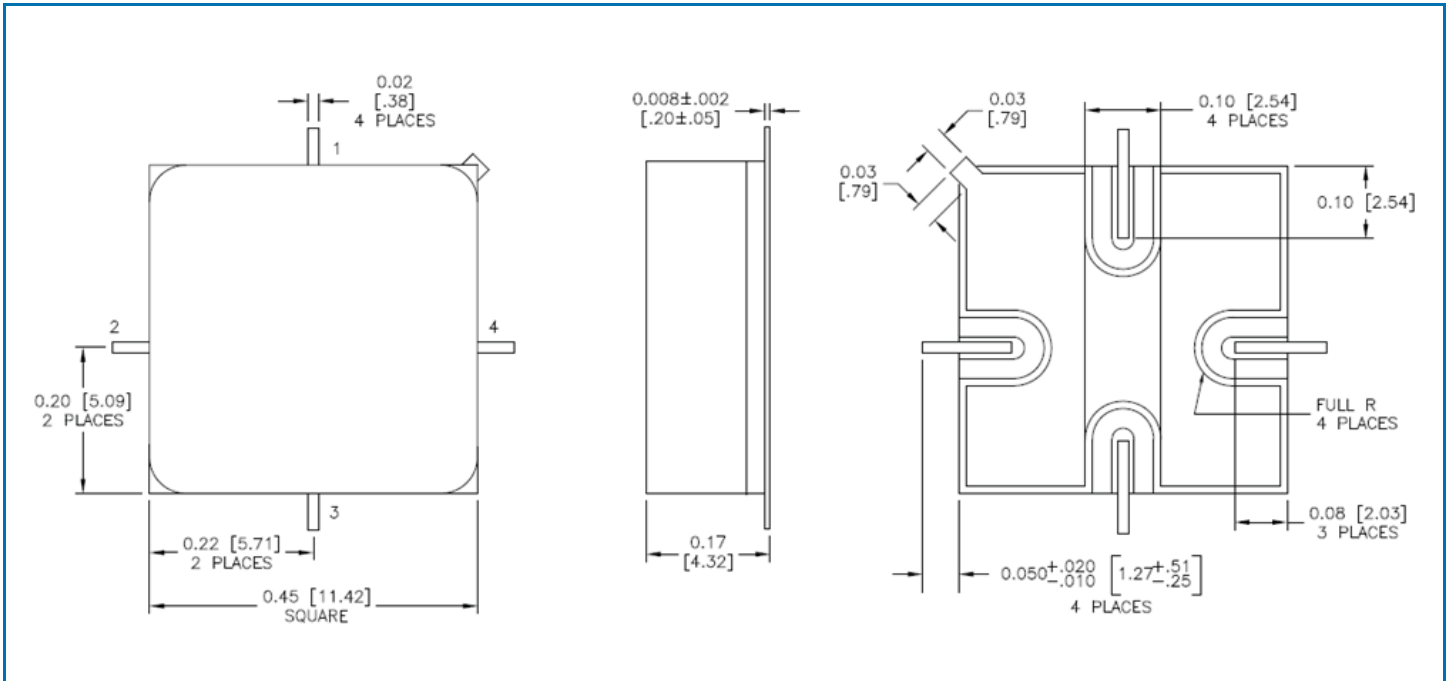

Application Circuit Schematic 100MHz to 4GHz

