

Small Signal Zener Diode

General Description

These diodes small signal Zener diodes, fabricated in planar technology. Miniature surface mount package is excellent for hand-held and portable applications where is space is limited.

Features and Benefits

- Silicon epitaxial planar diode
- Low Zener impedance and low leakage current
- Standard Zener voltage tolerance is 4.3%.
- Full lead (Pb)-free device and RoHS compliant device
- Available in "Green" device

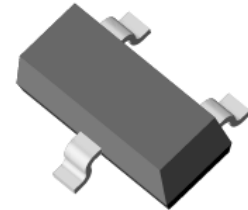

SOT-23



Applications

- Voltage regulator

Ordering Information

Part Number	Marking Code	Package	Packaging
SDZ5V1	Z 2 □	SOT-23	Tape & Reel

Marking Information

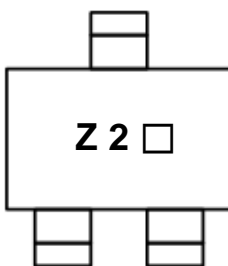

Z 2 = Specific Device Code

□ = Year & Week Code Marking

Pinning Information

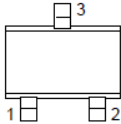
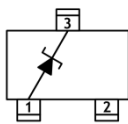
Pin	Description	Simplified Outline	Graphic Symbol
1	Anode		
2	Not Connected		
3	Cathode		

Absolute Maximum Ratings ($T_{amb}=25^{\circ}\text{C}$, Unless otherwise specified)

Characteristic	Symbol	Ratings	Unit
Power dissipation ¹⁾	P_D	200	mW
Operating junction temperature	T_J	150	$^{\circ}\text{C}$
Storage temperature range	T_{stg}	-55 $^{\circ}\text{C}$ to +150 $^{\circ}\text{C}$	$^{\circ}\text{C}$

¹⁾ Device mounted on FR-4 board with recommended pad layout.

Thermal Characteristics ($T_{amb}=25^{\circ}\text{C}$, Unless otherwise specified)

Characteristic	Symbol	Ratings	Unit
Thermal resistance, junction to ambient ¹⁾	$R_{th(j-a)}$	625	$^{\circ}\text{C}/\text{W}$

¹⁾ Device mounted on FR-4 board with recommended pad layout.

Electrical Characteristics ($T_{amb}=25^{\circ}\text{C}$, Unless otherwise specified)

Characteristic	Symbol	Test Condition	Min.	Typ.	Max.	Unit
Zener voltage	V_Z	$I_Z=5\text{mA}$	4.88	-	5.32	V
Dynamic impedance	Z_{ZT}	$I_Z=5\text{mA}$	-	-	70	Ω
KNEE dynamic impedance	Z_{ZK}	$I_Z=0.25\text{mA}$	-	-	2050	Ω
Reverse leakage current	I_R	$V_R=2\text{V}$	-	-	2	μA

Rating and Characteristic Curves

Fig. 1) Typical Zener Characteristics

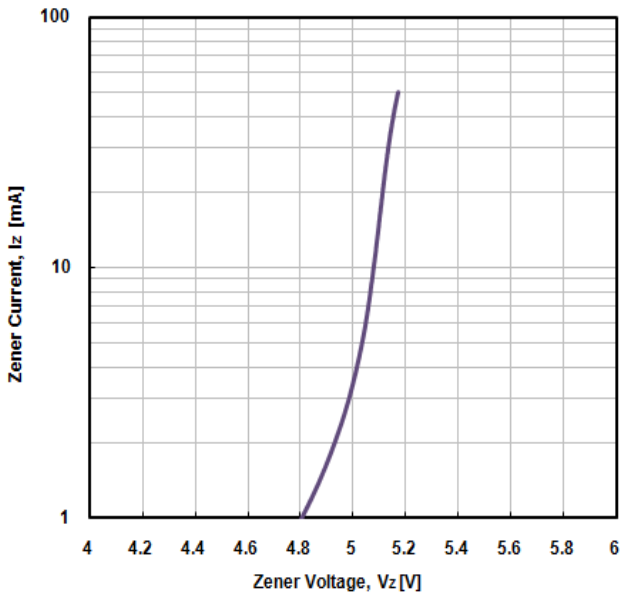

Fig. 2) Typical Forward Characteristics

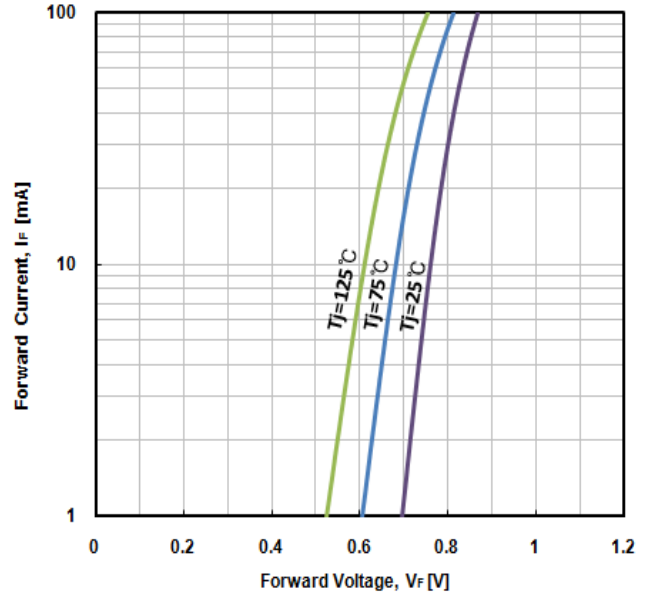

Fig. 3) Typical Capacitance Characteristics

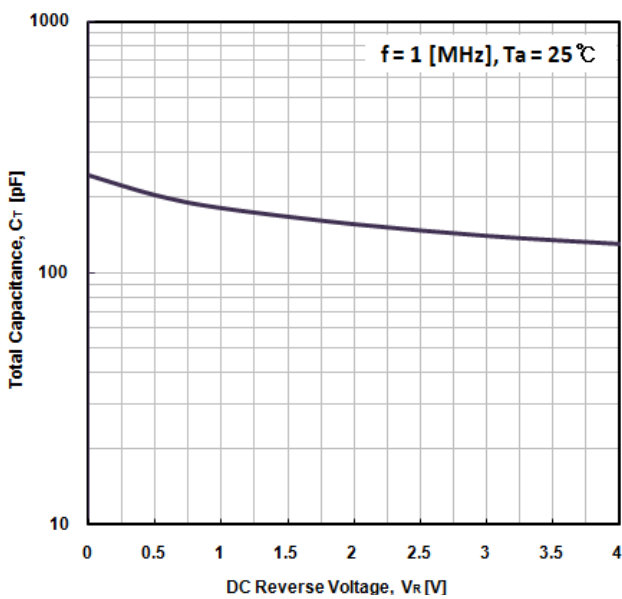
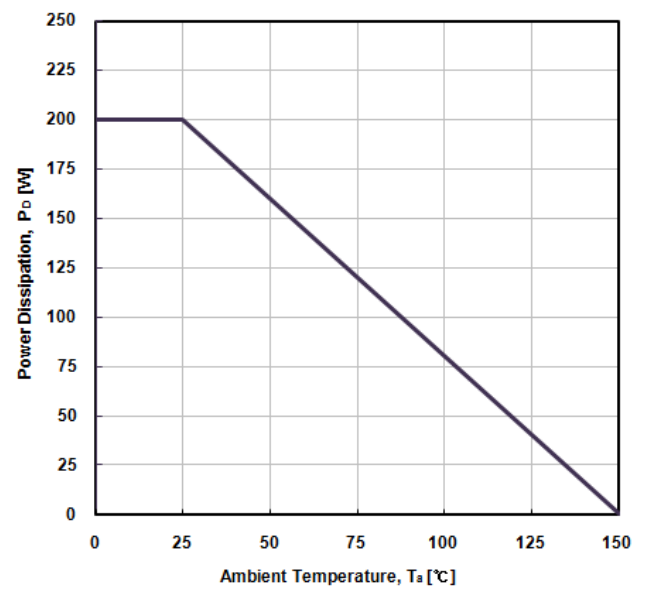
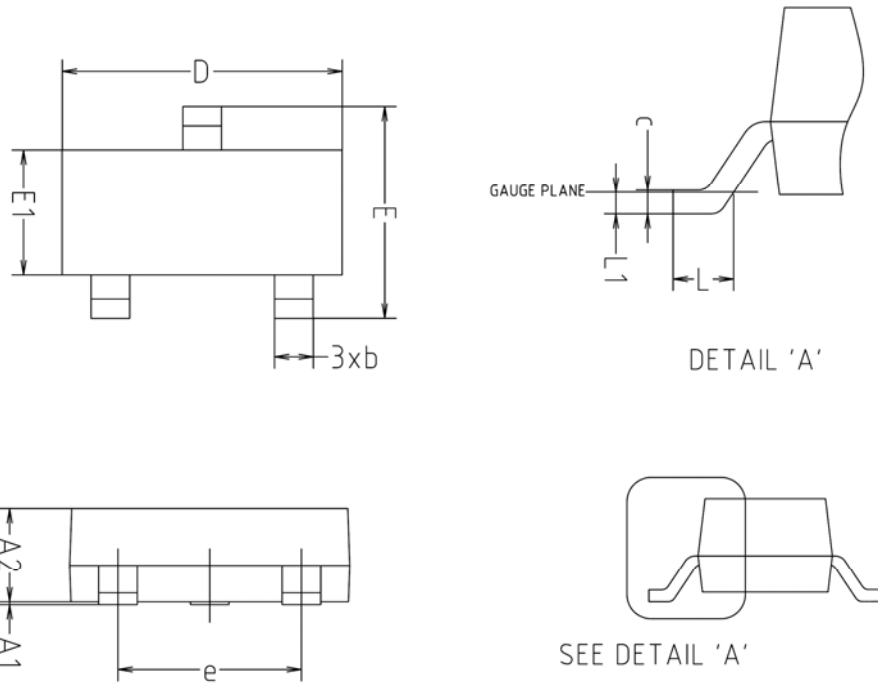

Fig. 4) Power Dissipation vs. Ambient Temperature



Package Outline Dimensions



SYMBOL	MILLIMETERS			NOTE
	MINIMUM	NOMINAL	MAXIMUM	
A1	0.00	-	0.10	
A2	0.82	-	1.02	
b	0.39	0.42	0.45	
c	0.09	0.12	0.15	
D	2.80	2.90	3.00	
E	2.20	2.40	2.60	
E1	1.20	1.30	1.40	
e	1.90BSC			
L	0.20	-	-	
L1	0.12BSC			

※ Recommend PCB solder land (Unit : mm)



The AUK Corp. products are intended for the use as components in general electronic equipment (Office and communication equipment, measuring equipment, home appliance, etc.).

Please make sure that you consult with us before you use these AUK Corp. products in equipments which require high quality and / or reliability, and in equipments which could have major impact to the welfare of human life(atomic energy control, airplane, spaceship, transportation, combustion control, all types of safety device, etc.). AUK Corp. cannot accept liability to any damage which may occur in case these AUK Corp. products were used in the mentioned equipments without prior consultation with AUK Corp..

Specifications mentioned in this publication are subject to change without notice.