





# SMT POWER INDUCTORS

## Shielded Drum Core - PL95XX Series



-  **Height:** 0.122 inches (3.1mm) Max
-  **Footprint:** 0.256 inches x 0.256 inches (6.5mm x 6.5mm) Max
-  **Inductance Range:** 2.15µH to 85.39µH
-  **Current Rating:** up to 2.60A

### Electrical Specifications @ 25°C — Operating Temperature -55°C to +130°C

Part Numbers	Inductance @I <sub>rated</sub> <sup>2</sup> (µH TYP)	I <sub>rated</sub> <sup>2</sup> (A)	DCR (mΩ)		Inductance @0A <sub>DC</sub> (µH)	Saturation Current <sup>3</sup> (A) @25°C	Heating <sup>4</sup> Current (A)
			TYP	MAX			
PL9501	2.15	2.60	15.3	17.6	2.5*	2.60	3.45
PL9502	2.58	2.30	16.6	20.3	3.3*	2.30	3.31
PL9503	3.43	2.10	22.5	27.0	4.0*	2.10	2.84
PL9504	4.63	1.85	24.9	31.1	5.0*	1.85	2.70
PL9505	5.22	1.70	32.3	41.9	6.0*	1.70	2.37
PL9506	6.57	1.50	37.9	49.9	8.0*	1.50	2.19
PL9507	8.65	1.30	45	54	10	1.30	2.01
PL9508	9.78	1.20	59	72	12	1.20	1.76
PL9509	12.13	1.10	66	82	15	1.10	1.65
PL9510	15.23	1.05	88	102	18	1.05	1.44
PL9511	18.70	0.95	103	119	22	0.95	1.33
PL9512	21.54	0.85	114	146	27	0.85	1.26
PL9513	27.71	0.76	155	183	33	0.76	1.08
PL9514	33.57	0.68	193	210	39	0.68	0.97
PL9515	40.15	0.60	196	230	47	0.60	0.96
PL9516	49.68	0.55	248	305	56	0.55	0.86
PL9517	60.66	0.48	278	351	68	0.48	0.81
PL9518	74.71	0.45	323	419	82	0.45	0.75
PL9519	85.39	0.40	417	520	100	0.40	0.66

\*Inductance at 0A<sub>DC</sub> tolerance on indicated part numbers is ±30%; tolerance is ±20% on all other parts. Optional Tape & Reel packaging can be ordered by adding a "T" suffix to the part number (i.e. PL9501 becomes PL9501T). **NOTES FROM TABLE:** (See back page)

## Mechanical

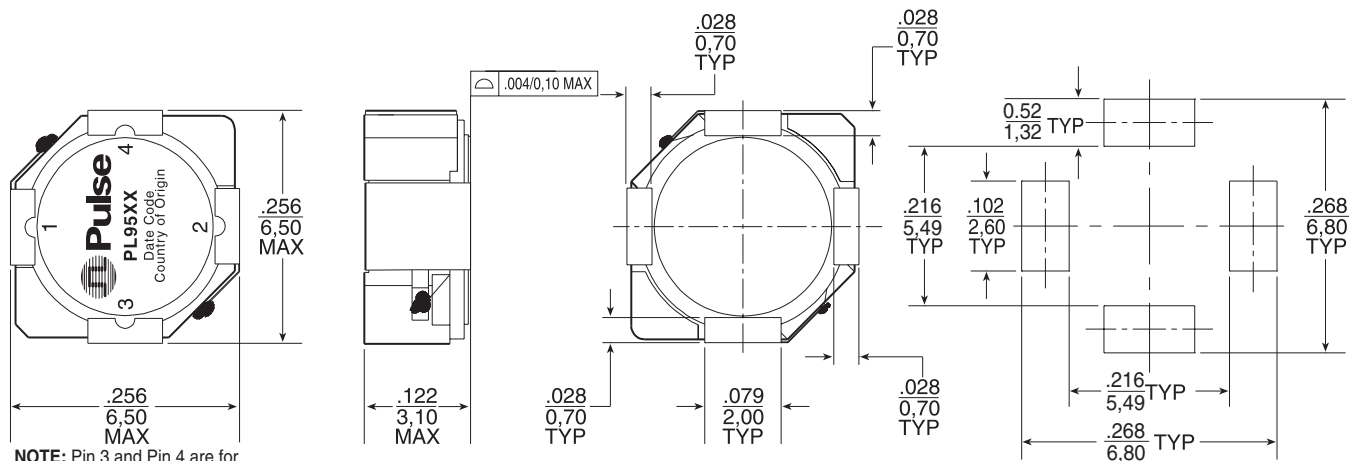

NOTE: Pin 3 and Pin 4 are for mechanical connection only.

SUGGESTED PAD LAYOUT

# SMT POWER INDUCTORS

## Shielded Drum Core - PL95XX Series



### Notes from Tables

1. Temperature of the component (ambient plus temperature rise) must be within specified operating temperature range.
2. The rated current as listed is either the saturation current or the heating current depending on which value is lower.
3. The saturation current is the current which causes the inductance to drop to 75% of its initial inductance at zero bias. This current is determined by placing the component at room ambient (25°C), and applying a short duration pulse current (to eliminate self-heating effects) to the component.
4. The heating current is the DC current, which causes the temperature of the part to increase by approximately 40°C. This current is determined by extending the terminals of the component with 30mm length 28 gauge buss wires and applying the current to the device for 30 minutes. The temperature is measured by placing the thermocouple between the winding and the shield.
5. In high volt\*time applications, additional heating in the component can occur due to core losses in the inductor which may necessitate derating the current in order to limit the temperature rise of the component. In order to determine the approximate total loss (or temperature rise) for a given application, both copper losses and core losses should be taken into account.

### Schematic

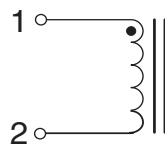

### TAPE & REEL LAYOUT

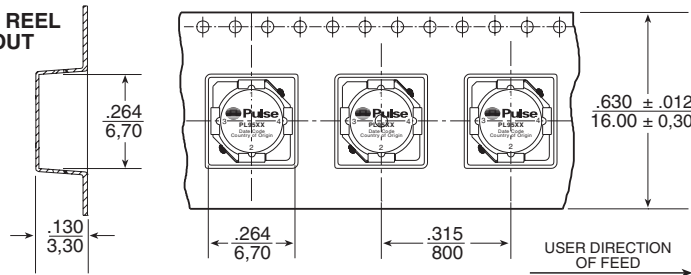

Weight . . . . . 0.6 grams  
 Tape & Reel . . . . . 2200/reel  
 Dimensions:  $\frac{\text{Inches}}{\text{mm}}$   
 Unless otherwise specified,  
 all tolerances are  $\pm \frac{.010}{0.25}$

### Inductance vs Current Characteristics

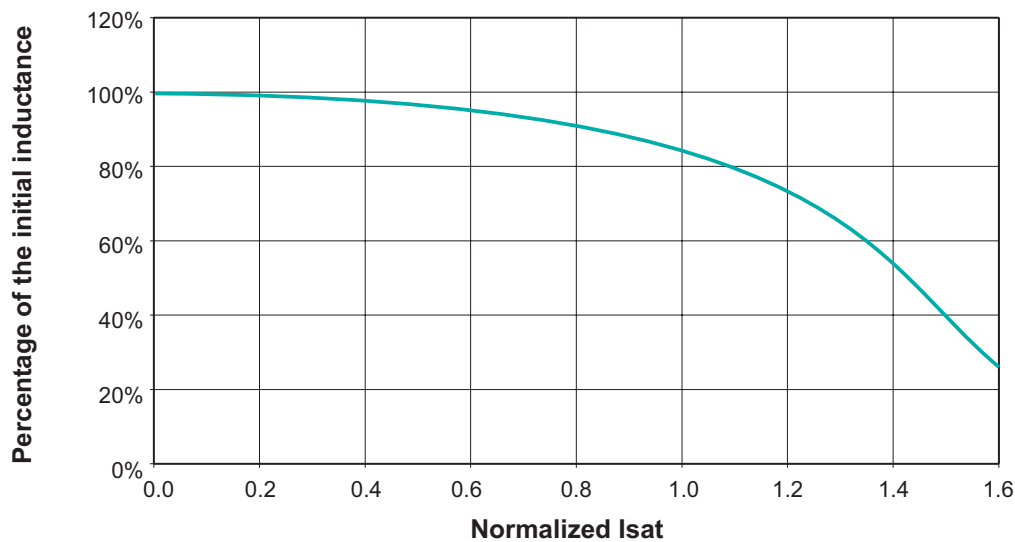

### For More Information:

**Pulse Worldwide Headquarters**  
 Two Pearl Buck Court  
 Bristol, PA 19007  
 U.S.A.

**Pulse Europe**  
 Einsteinstrasse 1  
 D-71083 Herrenberg  
 Germany

**Pulse China Headquarters**  
 B402, Shenzhen Academy of  
 Aerospace Technology Bldg.  
 10th Kejinan Rd.  
 High-Tech Zone  
 Nanshan District  
 Shenzhen, PR China 518057

**Pulse North China**  
 Room 1503  
 XinYin Building  
 No. 888 YiShan Rd.  
 Shanghai 200233  
 China

**Pulse South Asia**  
 135 Joo Seng Rd.  
 #03-02  
 PM Industrial Bldg.  
 Singapore 368363

**Pulse North Asia**  
 No. 26, Kao Ching Rd.  
 Yang Mei Chen  
 Taoyuan Hsien  
 Taiwan  
 R. O. C.

[www.pulseeng.com](http://www.pulseeng.com)

Tel: 215 781 6400  
 Fax: 215 781 6403

Tel: 49 7032 7806 0  
 Fax: 49 7032 7806 135

TEL: 86 755 33966678  
 FAX: 86 755 33966700

Tel: 86 21 54643211/2  
 Fax: 86 21 54643210

TEL: 65 6287 8998  
 FAX: 65 6280 0080

Tel: 886 3 4643715  
 Fax: 886 3 4641911

Performance warranty of products offered on this data sheet is limited to the parameters specified. Data is subject to change without notice. Other brand and product names mentioned herein may be trademarks or registered trademarks of their respective owners.

© Copyright, 2009. Pulse Engineering, Inc. All rights reserved.