

Single P-Channel, -20V, -0.65A, Power MOSFET

V _{DS} (V)	R _{ds(on)} (Ω)
-20	0.495@ V _{GS} = - 4.5V
	0.665@ V _{GS} = - 2.5V
	0.882@ V _{GS} = - 1.8V
ESD Protected	



Descriptions

The WPM2031 is P-Channel enhancement MOS Field Effect Transistor. Uses advanced trench technology and design to provide excellent R_{DS (ON)} with low gate charge. This device is suitable for use in DC-DC conversion, power switch and charging circuit. Standard Product WPM2031 is Pb-free and Halogen-free.

SOT-723

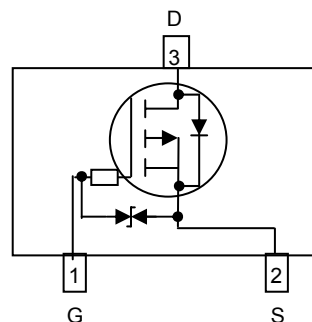

Pin configuration (Top view)

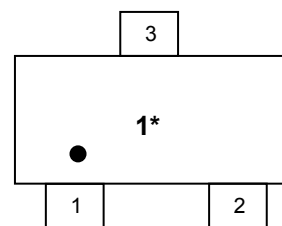

1 =Device Code
* = Month(A~Z)

Features

- Trench Technology
- Supper high density cell design
- Excellent ON resistance for higher DC current
- Extremely Low Threshold Voltage
- Small package SOT-723

Marking

Applications

- Driver for Relay, Solenoid, Motor, LED etc.
- DC-DC converter circuit
- Power Switch
- Load Switch
- Charging

Order information

Device	Package	Shipping
WPM2031-3/TR	SOT-723	8000/Reel&Tape

Absolute Maximum ratings

Parameter		Symbol	10 S	Steady State	Unit
Drain-Source Voltage		V_{DS}	-20		V
Gate-Source Voltage		V_{GS}	± 5		
Continuous Drain Current ^a	$T_A=25^\circ\text{C}$	I_D	-0.65	-0.60	A
	$T_A=70^\circ\text{C}$		-0.52	-0.48	
Maximum Power Dissipation ^a	$T_A=25^\circ\text{C}$	P_D	0.42	0.36	W
	$T_A=70^\circ\text{C}$		0.27	0.23	
Continuous Drain Current ^b	$T_A=25^\circ\text{C}$	I_D	-0.55	-0.51	A
	$T_A=70^\circ\text{C}$		-0.44	-0.41	
Maximum Power Dissipation ^b	$T_A=25^\circ\text{C}$	P_D	0.30	0.26	W
	$T_A=70^\circ\text{C}$		0.19	0.17	
Pulsed Drain Current ^c		I_{DM}	-1.0		A
Operating Junction Temperature		T_J	150		$^\circ\text{C}$
Lead Temperature		T_L	260		$^\circ\text{C}$
Storage Temperature Range		T_{stg}	-55 to 150		$^\circ\text{C}$

Thermal resistance ratings

Parameter		Symbol	Typical	Maximum	Unit
Junction-to-Ambient Thermal Resistance ^a	$t \leq 10 \text{ s}$	$R_{\theta JA}$	280	340	$^\circ\text{C/W}$
	Steady State		345	410	
Junction-to-Ambient Thermal Resistance ^b	$t \leq 10 \text{ s}$	$R_{\theta JA}$	400	470	
	Steady State		245	280	
Junction-to-Case Thermal Resistance		$R_{\theta JC}$	280	340	

a Surface mounted on FR-4 Board using 1 square inch pad size, 1oz copper

b Surface mounted on FR-4 board using minimum pad size, 1oz copper

c Pulse width $<380\mu\text{s}$, Duty Cycle $<2\%$

d Maximum junction temperature $T_J=150^\circ\text{C}$.

Electronics Characteristics (Ta=25°C, unless otherwise noted)

Parameter	Symbol	Test Conditions	Min	Typ	Max	Unit
OFF CHARACTERISTICS						
Drain-to-Source Breakdown Voltage	BV_{DSS}	$V_{GS} = 0\text{ V}, I_D = -250\mu\text{A}$	-20			V
Zero Gate Voltage Drain Current	I_{DSS}	$V_{DS} = -16\text{V}, V_{GS} = 0\text{V}$			-1	μA
Gate-to-source Leakage Current	I_{GSS}	$V_{DS} = 0\text{ V}, V_{GS} = \pm 5\text{V}$			± 5	μA
ON CHARACTERISTICS						
Gate Threshold Voltage	$V_{GS(TH)}$	$V_{GS} = V_{DS}, I_D = -250\mu\text{A}$	-0.44	-0.65	-0.81	V
Drain-to-source On-resistance ^{b, c}	$R_{DS(on)}$	$V_{GS} = -4.5\text{V}, I_D = -0.45\text{A}$		495	853	m Ω
		$V_{GS} = -2.5\text{V}, I_D = -0.35\text{A}$		665	1053	
		$V_{GS} = -1.8\text{V}, I_D = -0.25\text{A}$		882	1303	
Forward Transconductance	g_{FS}	$V_{DS} = -5\text{ V}, I_D = -0.45\text{A}$		1.25		S
CAPACITANCES, CHARGES						
Input Capacitance	C_{ISS}	$V_{GS} = 0\text{ V},$ $f = 100\text{ KHz},$ $V_{DS} = -10\text{ V}$		74.5		pF
Output Capacitance	C_{OSS}			10.8		
Reverse Transfer Capacitance	C_{RSS}			10.2		
Total Gate Charge	$Q_{G(TOT)}$	$V_{GS} = -4.5\text{ V},$ $V_{DS} = -10\text{ V},$ $I_D = -0.45\text{A}$		1.67		nC
Threshold Gate Charge	$Q_{G(TH)}$			0.17		
Gate-to-Source Charge	Q_{GS}			0.30		
Gate-to-Drain Charge	Q_{GD}			0.59		
SWITCHING CHARACTERISTICS						
Turn-On Delay Time	$t_d(ON)$	$V_{GS} = -4.5\text{ V},$ $V_{DS} = -10\text{ V},$ $I_D = -0.45\text{A}$ $R_G = 6\ \Omega$		0.50		μs
Rise Time	t_r			1.76		
Turn-Off Delay Time	$t_d(OFF)$			7.0		
Fall Time	t_f			8.5		
BODY DIODE CHARACTERISTICS						
Forward Voltage	V_{SD}	$V_{GS} = 0\text{ V}, I_S = -0.15\text{A}$		-0.75	-1.5	V

Typical Characteristics (Ta=25°C, unless otherwise noted)

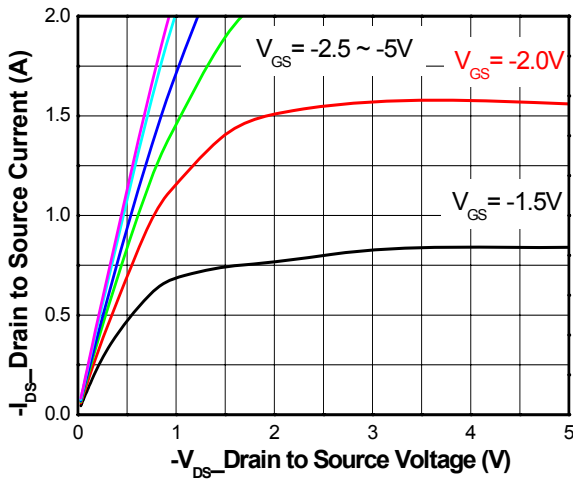

Output characteristics

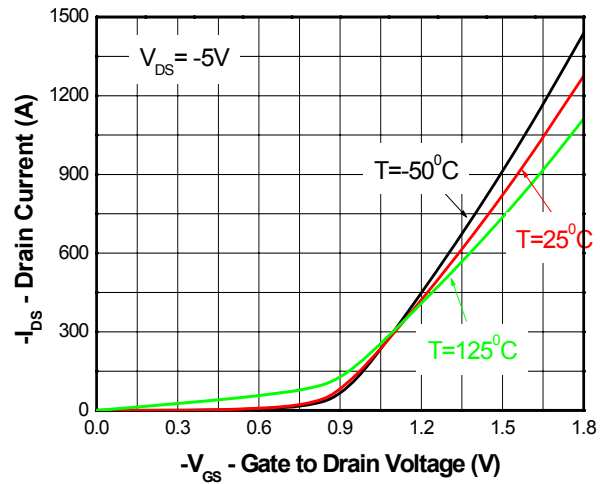

Transfer characteristics

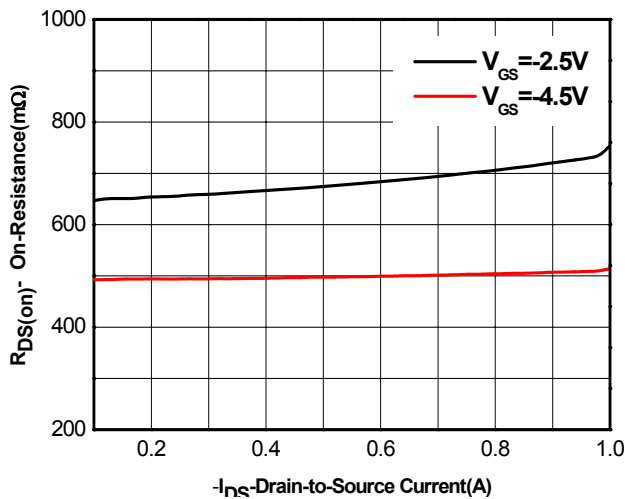

On-Resistance vs. Drain current

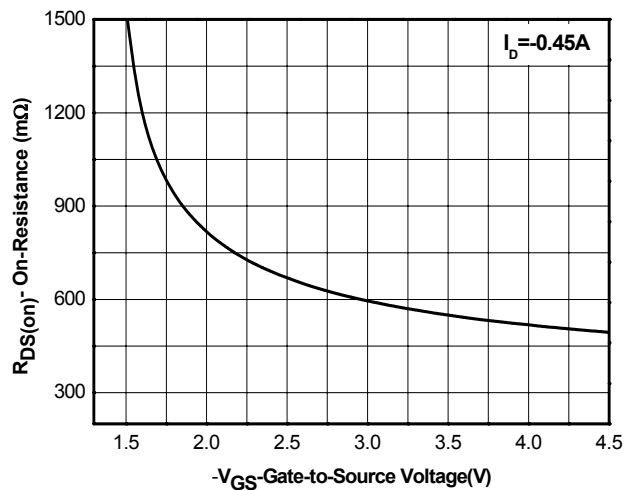

On-Resistance vs. Gate-to-Source voltage

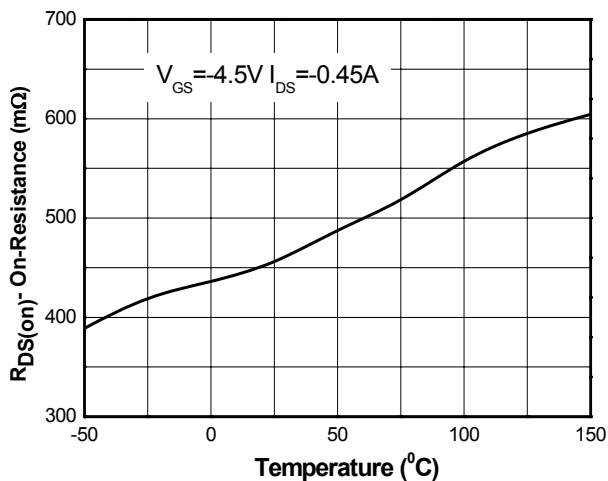

On-Resistance vs. Junction temperature

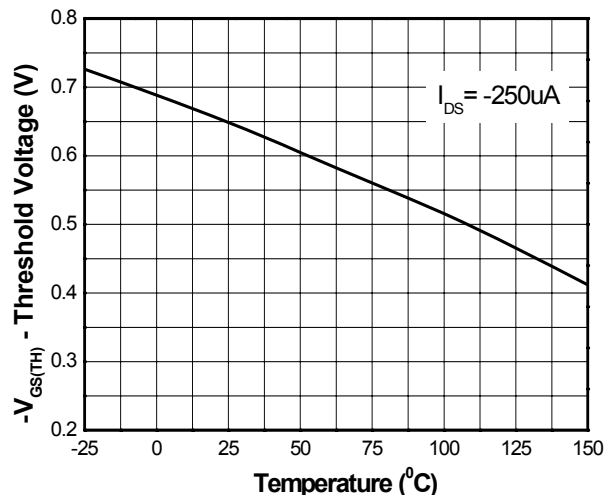

Threshold voltage vs. Temperature

WPM2031

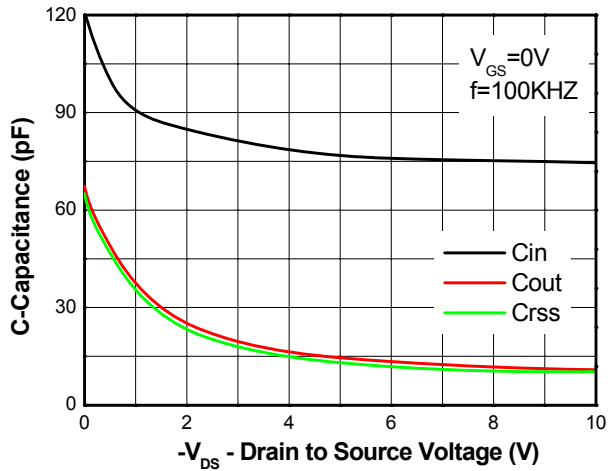

Capacitance

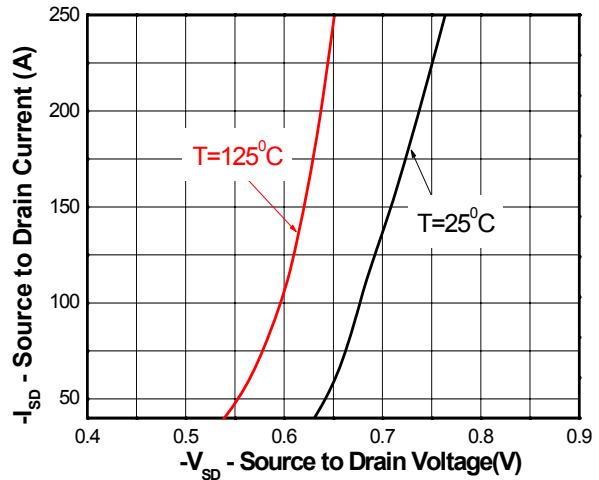

Body diode forward voltage

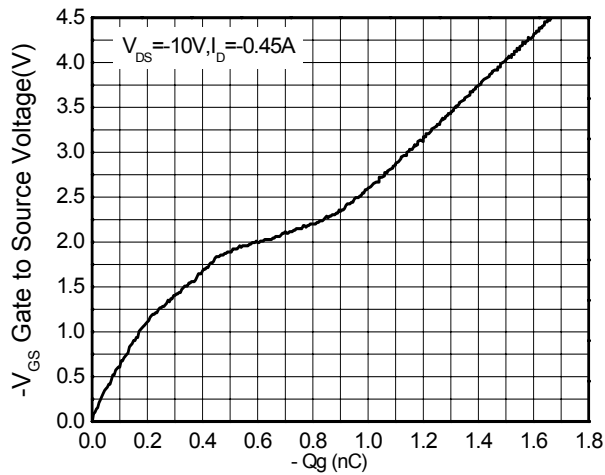

Gate Charge Characteristics

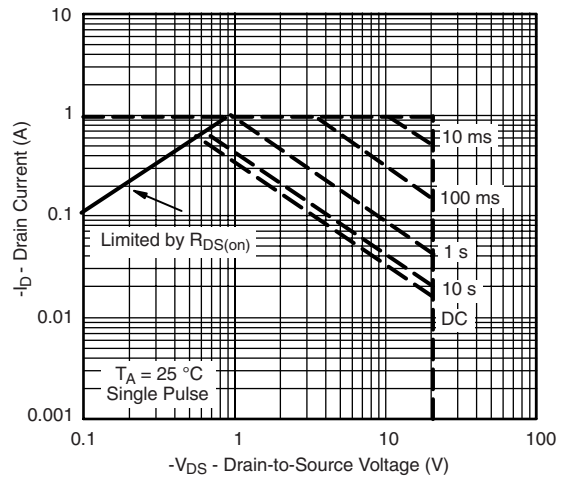

Safe operating power

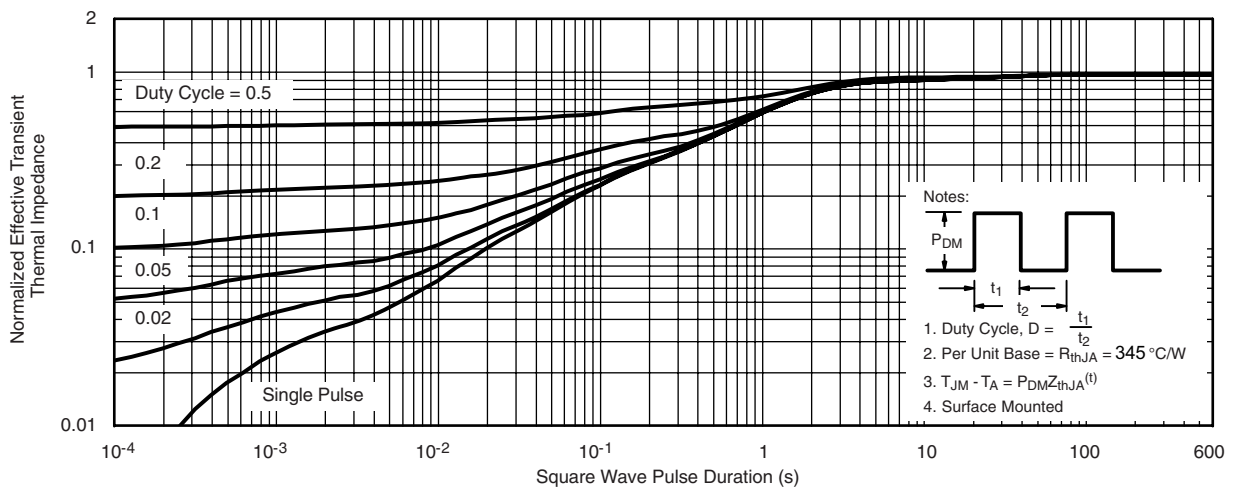

Transient thermal response (Junction-to-Ambient)

Package outline dimensions

SOT-723

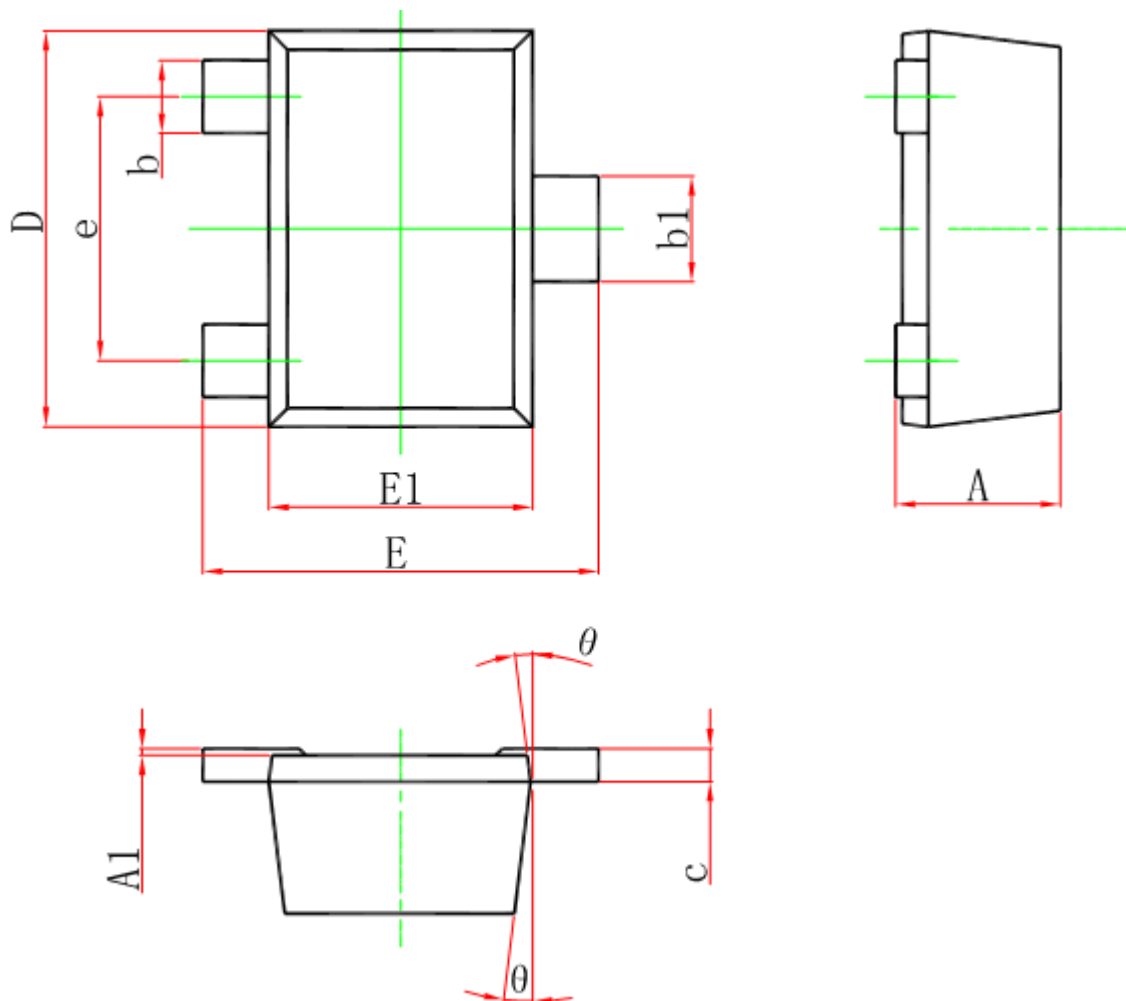

Symbol	Dimensions in millimeter	
	Min.	Max.
A		0.500
A1	0.000	0.050
b	0.170	0.270
b1	0.270	0.370
c		0.150
D	1.150	1.250
E	1.150	1.250
E1	0.750	0.850
e	0.800TYP	
θ	7° REF	