



**N-channel Enhancement-mode Power MOSFET**

**Fast Switching Characteristics**

**Low Gate Charge**

**Simple Drive Requirement**

**100% Avalanche-tested**

**RoHS-compliant, halogen-free SOT-89 package**

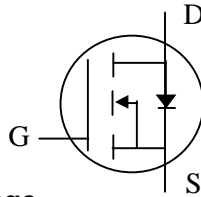

$BV_{DSS}$	400V
$R_{DS(ON)}$	16Ω
$I_D$	200mA

**Description**

Advanced Power MOSFETs from APEC provide the designer with the best combination of fast switching, low on-resistance and cost-effectiveness.

The AP01N40G-HF-3 is in the popular SOT-89 small package which is widely used in commercial and industrial applications where a small board footprint is required.

This device is well suited for use in low current applications such as small switching power supplies and load switches.

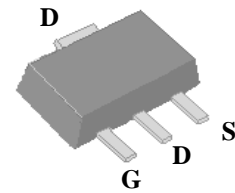

**SOT-89 (G)**

**Absolute Maximum Ratings**

Symbol	Parameter	Rating	Units
$V_{DS}$	Drain-Source Voltage	400	V
$V_{GS}$	Gate-Source Voltage	±20	V
$I_D$ at $T_A=25^{\circ}C$	Continuous Drain Current	0.2	A
$I_D$ at $T_A=70^{\circ}C$	Continuous Drain Current	0.14	A
$I_{DM}$	Pulsed Drain Current <sup>1</sup>	0.8	A
$P_D$ at $T_A=25^{\circ}C$	Total Power Dissipation	1.25	W
$T_{STG}$	Storage Temperature Range	-55 to 150	°C
$T_J$	Operating Junction Temperature Range	-55 to 150	°C

**Thermal Data**

Symbol	Parameter	Value	Units
Rthj-a	Maximum Thermal Resistance, Junction-ambient <sup>3</sup>	100	°C/W

**Ordering Information**

**AP01N40G-HF-3TR** : in RoHS-compliant halogen-free SOT-89, shipped on tape and reel, 1000pcs/reel



**Electrical Specifications at  $T_j=25^\circ\text{C}$  (unless otherwise specified)**

Symbol	Parameter	Test Conditions	Min.	Typ.	Max.	Units
$BV_{DSS}$	Drain-Source Breakdown Voltage	$V_{GS}=0V, I_D=250\mu A$	400	-	-	V
$R_{DS(ON)}$	Static Drain-Source On-Resistance <sup>2</sup>	$V_{GS}=10V, I_D=0.2A$	-	-	16	$\Omega$
$V_{GS(th)}$	Gate Threshold Voltage	$V_{DS}=V_{GS}, I_D=250\mu A$	1	-	3	V
$g_{fs}$	Forward Transconductance	$V_{DS}=10V, I_D=0.2A$	-	0.2	-	S
$I_{DSS}$	Drain-Source Leakage Current	$V_{DS}=400V, V_{GS}=0V$	-	-	10	$\mu A$
$I_{GSS}$	Gate-Source Leakage	$V_{GS}=\pm 20V, V_{DS}=0V$	-	-	$\pm 100$	nA
$Q_g$	Total Gate Charge <sup>2</sup>	$I_D=1A$	-	2.9	4.6	nC
$Q_{gs}$	Gate-Source Charge	$V_{DS}=320V$	-	0.6	-	nC
$Q_{gd}$	Gate-Drain ("Miller") Charge	$V_{GS}=10V$	-	0.6	-	nC
$t_{d(on)}$	Turn-on Delay Time <sup>2</sup>	$V_{DD}=200V$	-	7.7	-	ns
$t_r$	Rise Time	$I_D=1A$	-	12	-	ns
$t_{d(off)}$	Turn-off Delay Time	$R_G=3.3\Omega$	-	23	-	ns
$t_f$	Fall Time	$V_{GS}=10V$	-	73	-	ns
$C_{iss}$	Input Capacitance	$V_{GS}=0V$	-	76	125	pF
$C_{oss}$	Output Capacitance	$V_{DS}=25V$	-	11	-	pF
$C_{rss}$	Reverse Transfer Capacitance	$f=1.0MHz$	-	4	-	pF

**Source-Drain Diode**

Symbol	Parameter	Test Conditions	Min.	Typ.	Max.	Units
$V_{SD}$	Forward On Voltage <sup>2</sup>	$I_S=0.8A, V_{GS}=0V$	-	-	1.5	V
$t_{rr}$	Reverse Recovery Time <sup>2</sup>	$I_S=1A, V_{GS}=0V$	-	260	-	ns
$Q_{rr}$	Reverse Recovery Charge	$di/dt=100A/\mu s$	-	460	-	nC

**Notes:**

1. Pulse width limited by maximum junction temperature.
2. Pulse test
3. Surface mount on FR4 board,  $t < 10s$

THIS PRODUCT IS SENSITIVE TO ELECTROSTATIC DISCHARGE, PLEASE HANDLE WITH CAUTION.

USE OF THIS PRODUCT AS A CRITICAL COMPONENT IN LIFE SUPPORT OR OTHER SIMILAR SYSTEMS IS NOT AUTHORIZED.

APEC DOES NOT ASSUME ANY LIABILITY ARISING OUT OF THE APPLICATION OR USE OF ANY PRODUCT OR CIRCUIT DESCRIBED HEREIN; NEITHER DOES IT CONVEY ANY LICENSE UNDER ITS PATENT RIGHTS, NOR THE RIGHTS OF OTHERS.

APEC RESERVES THE RIGHT TO MAKE CHANGES WITHOUT FURTHER NOTICE TO ANY PRODUCTS HEREIN TO IMPROVE RELIABILITY, FUNCTION OR DESIGN.



Typical Electrical Characteristics

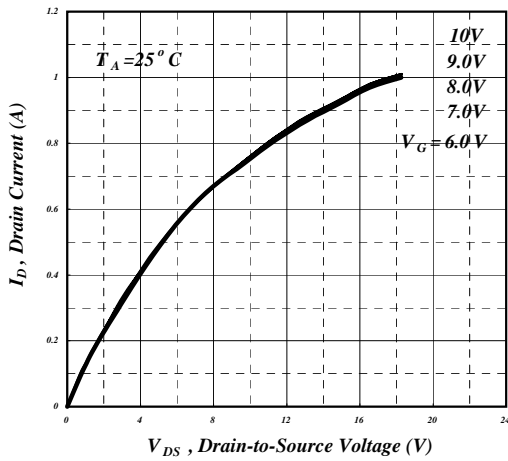

Fig 1. Typical Output Characteristics

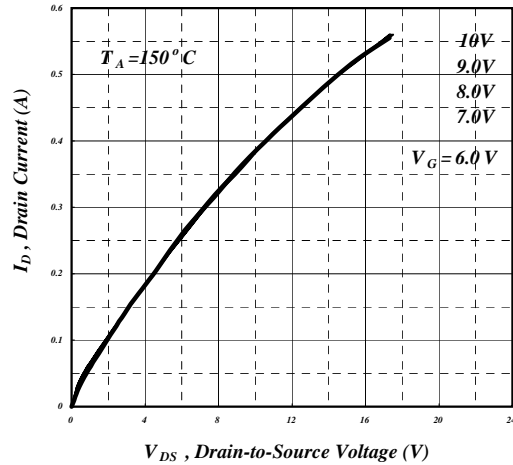

Fig 2. Typical Output Characteristics

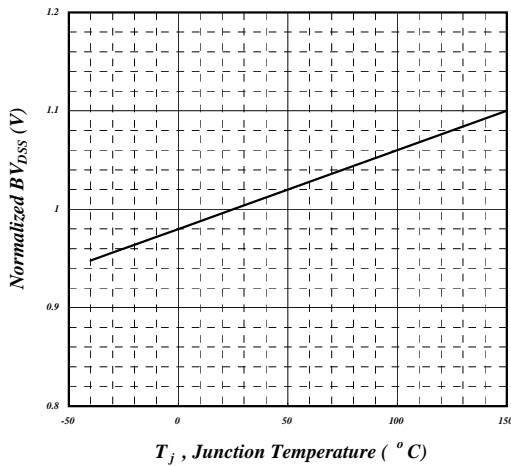

Fig 3. Normalised BVDSS vs. Junction Temperature

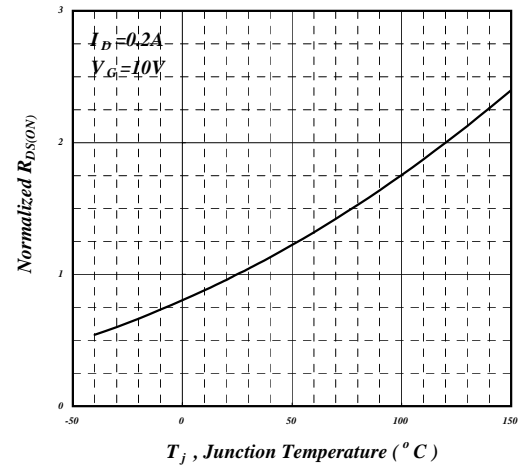

Fig 4. Normalized On-Resistance vs. Junction Temperature

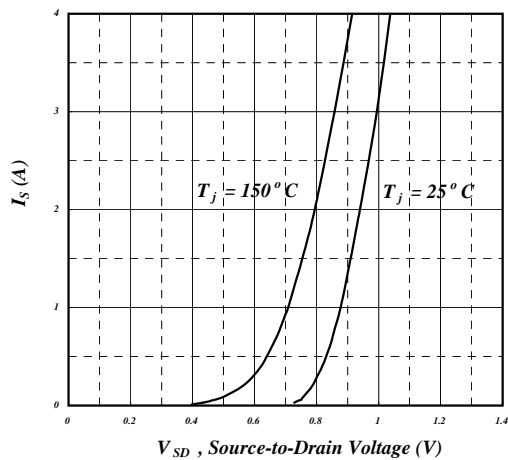

Fig 5. Forward Characteristic of Reverse Diode

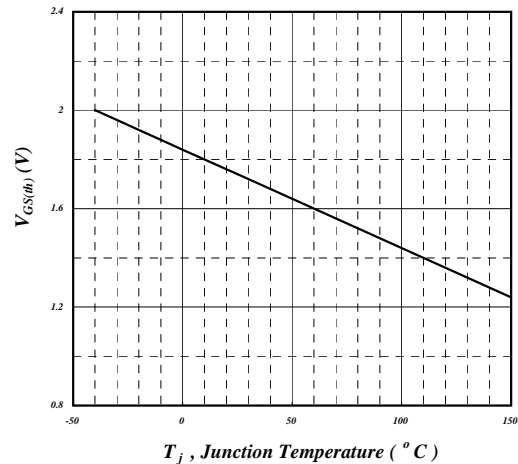

Fig 6. Gate Threshold Voltage vs. Junction Temperature



Typical Electrical Characteristics (cont.)

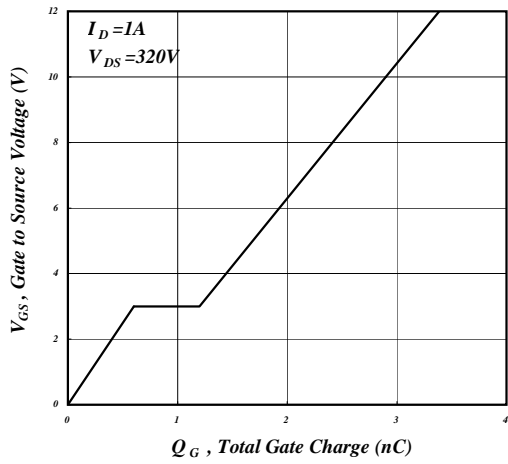

Fig 7. Gate Charge Characteristics

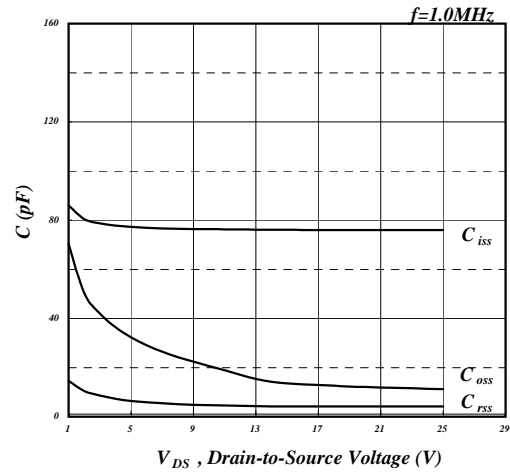

Fig 8. Typical Capacitance Characteristics

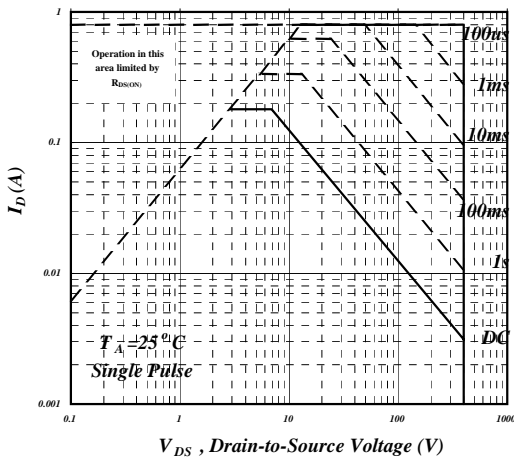

Fig 9. Maximum Safe Operating Area

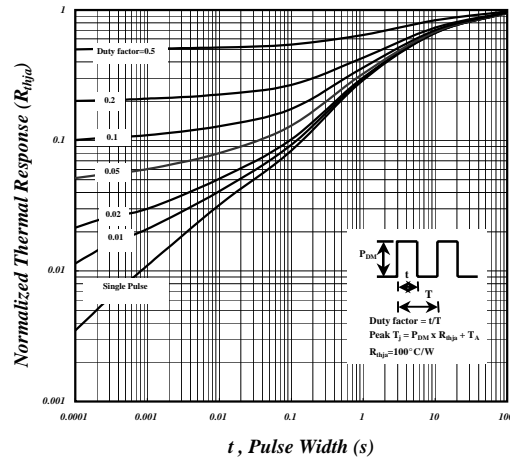

Fig 10. Effective Transient Thermal Impedance

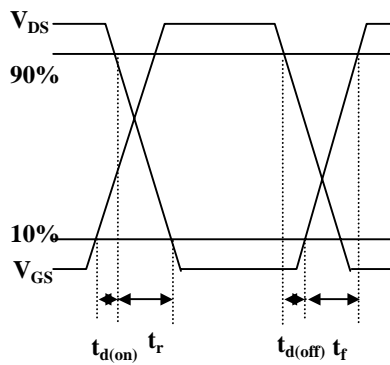

Fig 11. Switching Time Waveform

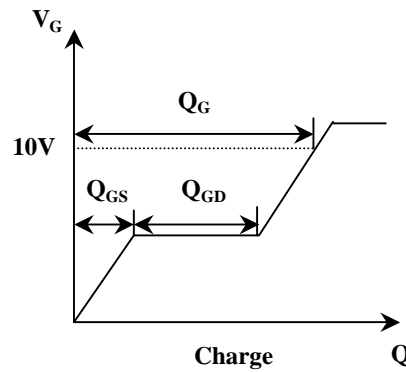
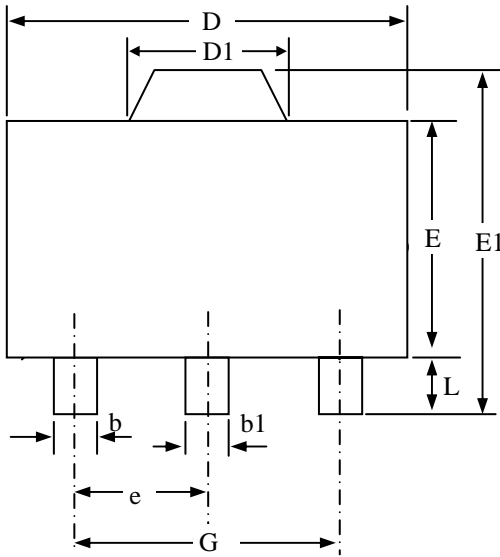

Fig 12. Gate Charge Waveform



**Package Dimensions: SOT-89**



SYMBOLS	Millimeters		
	MIN	NOM	MAX
b	0.32	0.42	0.52
b1	0.40	0.50	0.60
D1	1.40	1.60	1.80
D	4.40	4.50	4.60
E	2.30	2.45	2.60
E1	3.80	4.05	4.30
e	1.30	1.50	1.70
G	2.80	3.00	3.20
A	1.40	1.50	1.60
C	0.34	0.39	0.44
L	0.80	1.00	1.20

1. All dimensions are in millimeters.
2. Dimensions do not include mold protrusions.

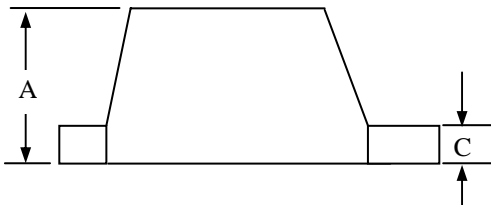

**Marking Information:**

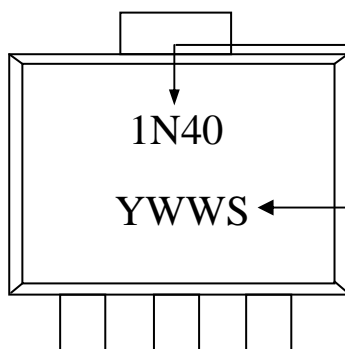

Product: AP01N40G

Package:

G = RoHS-compliant, halogen-free SOT-89

Date/lot code

Y = Last digit of the year

WW = Work week

S = lot code sequence

**Packing:**

Parts are shipped on tape and reel, 1000pcs per reel. The reel is sealed in a moisture barrier bag (MBB). Once the bag is opened, the parts should be considered moisture-sensitive, as defined in IPC/JEDEC standard, J-STD-020C, with MSL=3, and handled accordingly.