



512Kx8 MONOLITHIC SRAM, SMD 5962-95613

FEATURES

- Access Times 15, 17, 20, 25, 35, 45, 55ns
- MIL-STD-883 Compliant Devices Available
- Revolutionary, Center Power/Ground Pinout JEDEC Approved
 - 36 lead Ceramic SOJ (Package 100)
 - 36 lead Ceramic Flat Pack (Package 226)
- Evolutionary, Corner Power/Ground Pinout JEDEC Approved
 - 32 pin Ceramic DIP (Package 300)
 - 32 lead Ceramic SOJ (Package 101)
 - 32 lead Ceramic Thinpack™ Flat Pack (Package 321)
- 32 pin, Rectangular Ceramic Leadless Chip Carrier (Package 601)
- Commercial, Industrial and Military Temperature Range
- 5V Power Supply
- Low Power CMOS
- Low Power Data Retention for Battery Back-up Operation
- TTL Compatible Inputs and Outputs

*This product is subject to change without notice.

REVOLUTIONARY PINOUT

36 FLAT PACK
36 CSOJ

TOP VIEW

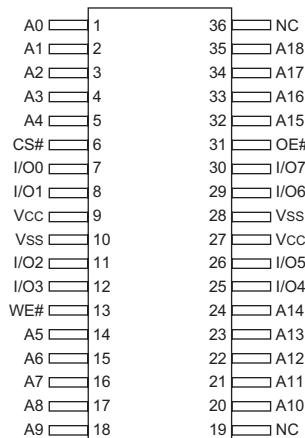

EVOLUTIONARY PINOUT

32 DIP
32 CSOJ (DE)
32 FLAT PACK (FF)

TOP VIEW

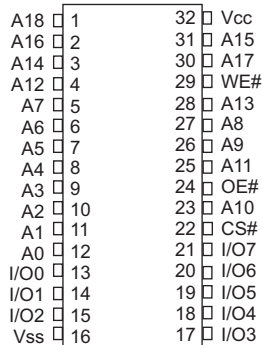

32 CLCC

TOP VIEW

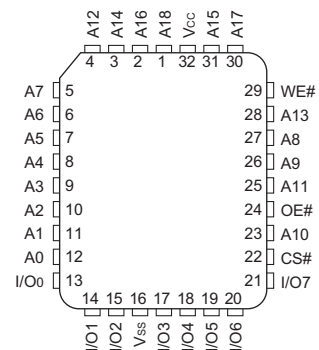

PIN DESCRIPTION

A0-18	Address Inputs
I/O 0-7	Data Input/Output
CS#	Chip Select
OE#	Output Enable
WE#	Write Enable
V _{cc}	+5.0V Power
GND	Ground

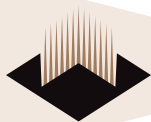

Absolute Maximum Ratings

Parameter	Symbol	Min	Max	Unit
Operating Temperature	T _A	-55	+125	°C
Storage Temperature Range	T _{STG}	-65	+150	°C
Signal Voltage Range to GND	V _G	-0.5	V _{CC} -0.5	V
Junction Temperature	T _J		150	°C
Supply Voltage Range (V _{CC})	V _{CC}	-0.5	7.0	V

Truth Table

CS#	OE#	WE#	MODE	DATA I/O	POWER
H	X	X	Standby	High Z	Standby
L	L	H	Read	Data Out	Active
L	X	L	Write	Data In	Active
L	H	H	Out Disable	High Z	Active

Recommended Operating Conditions

Parameter	Symbol	Min	Max	Unit
Supply Voltage	V _{CC}	4.5	5.5	V
Input High Voltage	V _{IH}	2.2	V _{CC} + 0.3	V
Input Low Voltage	V _{IL}	-0.3	+0.8	V
Operating Temp. (Mil)	T _A	-55	+125	°C

Capacitance

(T_A = +25°C)

Parameter	Symbol	Conditions	Package	Speed (ns)	Max	Unit
Input capacitance	C _{IN}	V _{IN} = 0 V, f = 1.0 MHz	32 pin CSOJ, DIP, Flat Pack Evolutionary	15 to 55	20	pF
			32 pin CLCC	15 to 55	15	pF
			36 pin CSOJ & Flat Pack Revolutionary	15 to 35	12	pF
				45 to 55	20	pF
Output capacitance	C _{OUT}	V _{OUT} = 0 V, f = 1.0 MHz	32 pin CSOJ, DIP, Flat Pack Revolutionary	15 to 55	20	pF
			36 pin CSOJ & Flat Pack Revolutionary	15 to 35	12	pF
				45 to 55	20	pF
					20	pF

This parameter is guaranteed by design but not tested.

DC Characteristics - CMOS Compatible

(V_{CC} = 5.0V, GND = 0V, -55°C ≤ T_A ≤ 125°C)

Parameter	Symbol	Conditions	Min	Max	Unit
Input Leakage Current	I _{LI}	V _{CC} = 5.5, V _{IN} = GND to V _{CC}		10	A
Output Leakage Current	I _{LO}	CS# = V _{IH} , OE# = V _{IH} , V _{OUT} = GND TO V _{CC}		10	A
Operating Supply Current*	I _{CC}	CS# = V _{IH} , OE# = V _{IH} , f = 5MHz, V _{CC} = 5.5,		160	mA
Standby Current	I _{SS}	CS# = V _{IH} , OE# = V _{IH} , f = 5MHz, V _{CC} = 5.5		0.45	mA
Output Low Voltage	V _{OL}	I _{OL} = 6mA for 17 - 35ns, I _{OL} = 2.1mA for 45 - 55ns, V _{CC} = 4.5		0.4	V
Output High Voltage	V _{OH}	I _{OH} = -4.0mA for 17 - 35ns, I _{OH} = 1.0mA for 45 - 55ns, V _{CC} = 4.5	2.4		V

Data retention characteristics for low power "I" version

Parameter	Symbol	Conditions	Min	Max	Unit
Data Retention Supply Voltage	V _{DR}	CS# ¹ V _{CC} -0.2V	2.0	5.5	V
Low Power Data Retention	I _{CCDR1}	V _{CC} = 3V		7	mA
Low Power Data Retention	I _{CCDR2}	V _{CC} = 2V		2	mA

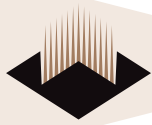

AC Characteristics

($V_{CC} = 5.0V, GND = 0V, -55^{\circ}C \leq T_A \leq 125^{\circ}C$)

Parameter	Symbol	-15		-17		-20		-25		-35		-45		-55		Unit
		Min	Max	Min	Max	Min	Max	Min	Max	Min	Max	Min	Max	Min	Max	
Read Cycle Time	t _{RC}	15		17		20		25		35		45		55		ns
Address Access Time	t _{AA}		15		17		20		25		35		45		55	ns
Output Hold from Address Change	t _{OH}	0		0		0		0		0		0		0		ns
Chip Select Access Time	t _{ACS}		15		17		20		25		35		45		55	ns
Output Enable to Output Valid	t _{OE}		8		9		10		12		25		25		25	ns
Chip Select to Output in Low Z	t _{ICLZ1}	2		2		2		2		4		4		4		ns
Output Enable to Output in Low Z	t _{OLZ1}	0		0		0		0		0		0		0		ns
Chip Disable to Output in High Z	t _{ICHZ1}		8		9		10		12		15		20		20	ns
Output Disable to Output in High Z	t _{IOHZ1}		8		9		10		12		15		20		20	ns

AC Characteristics

($V_{CC} = 5.0V, GND = 0V, -55^{\circ}C \leq T_A \leq 125^{\circ}C$)

Parameter	Symbol	-15		-17		-20		-25		-35		-45		-55		Unit
		Min	Max	Min	Max	Min	Max	Min	Max	Min	Max	Min	Max	Min	Max	
Write Cycle Time	t _{WC}	15		17		20		25		35		45		55		ns
Chip Select to End of Write	t _{CW}	13		14		14		15		25		35		50		ns
Address Valid to End of Write	t _{AW}	13		14		14		15		25		35		50		ns
Data Valid to End of Write	t _{DW}	8		9		10		10		20		25		25		ns
Write Pulse Width	t _{WP}	13		14		14		15		25		35		40		ns
Address Setup Time	t _{AS}	2		2		2		2		2		2		2		ns
Address Hold Time	t _{AH}	0		0		0		0		0		5		5		ns
Output Active from End of Write	t _{OW1}	2		2		3		4		4		5		5		ns
Write Enable to Output in High Z	t _{WHZ1}		8		9		9		10		15		20		25	ns
Data Hold Time	t _{DH}	0		0		0		0		0		0		0		ns

1. This parameter is guaranteed by design but not tested.

AC TEST CIRCUIT

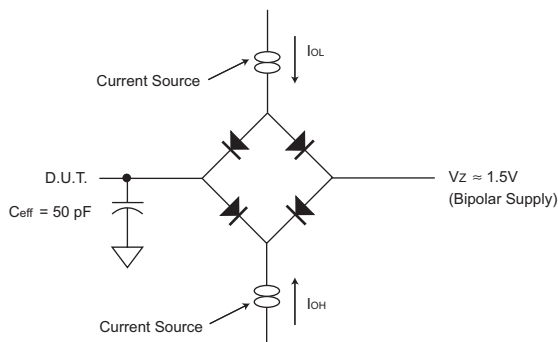

AC TEST CONDITIONS

Parameter	Typ	Unit
Input Pulse Levels	$V_{IL} = 0, V_{IH} = 3.0$	V
Input Rise and Fall	5	ns
Input and Output Reference Level	1.5	V
Output Timing Reference Level	1.5	V

Notes:
 V_Z is programmable from -2V to +7V.
 I_{OL} & I_{OH} programmable from 0 to 16mA.
 Tester Impedance $Z_0 = 75 \Omega$.
 V_Z is typically the midpoint of V_{OH} and V_{OL} .
 I_{OL} & I_{OH} are adjusted to simulate a typical resistive load circuit.
 ATE tester includes jig capacitance.



TIMING WAVEFORM - READ CYCLE

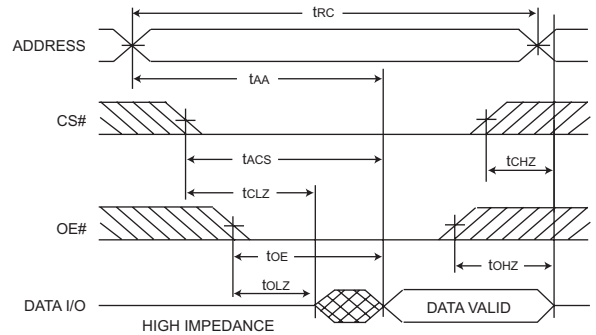
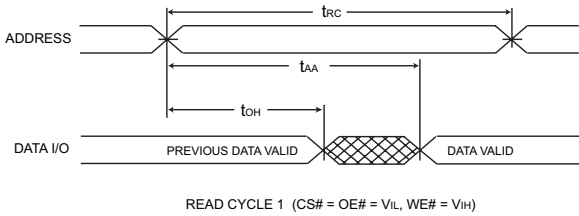

WRITE CYCLE - WE# CONTROLLED

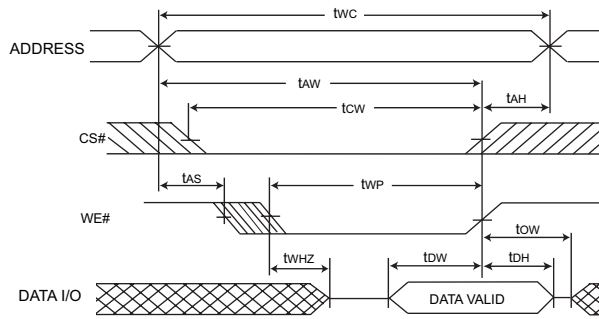

WRITE CYCLE - CS# CONTROLLED

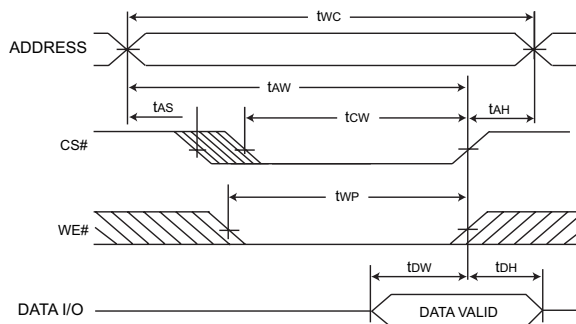

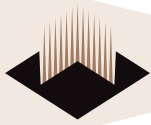

PACKAGE 100: 36 LEAD, CERAMIC SOJ

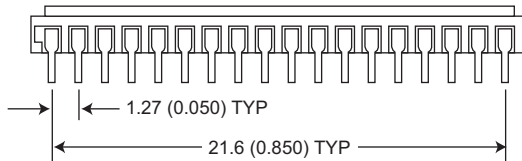
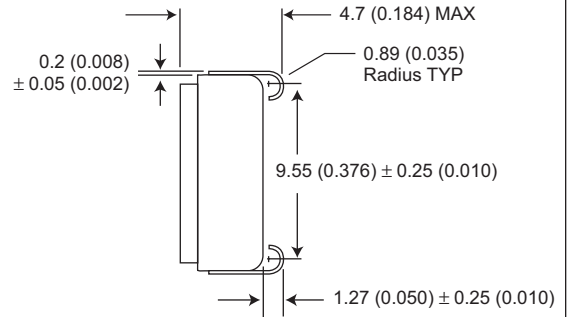
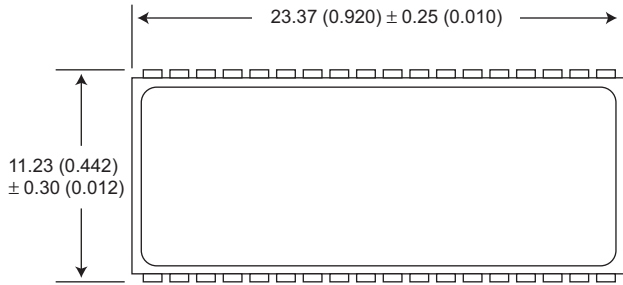

ALL LINEAR DIMENSIONS ARE MILLIMETERS AND PARENTHETICALLY IN INCHES

PACKAGE 101: 32 LEAD, CERAMIC SOJ

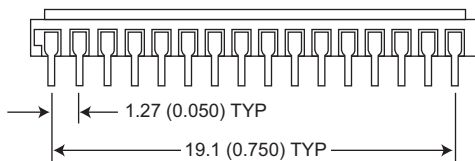
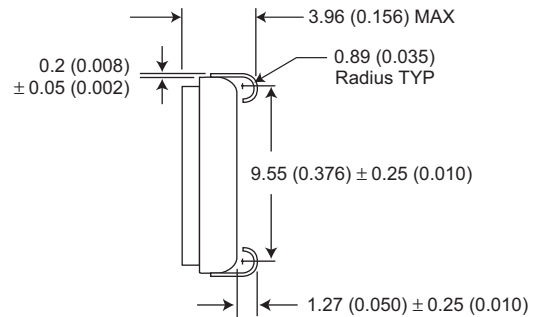
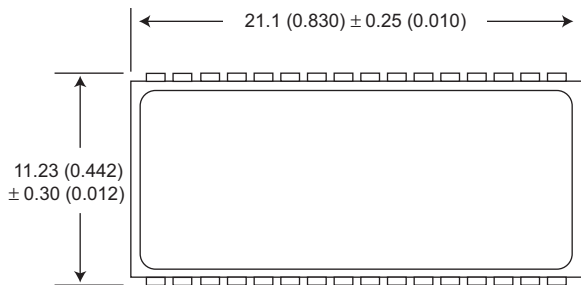

ALL LINEAR DIMENSIONS ARE MILLIMETERS AND PARENTHETICALLY IN INCHES

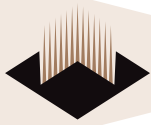

PACKAGE 321: 32 PIN CERAMIC THINPACK™ FLATPACK

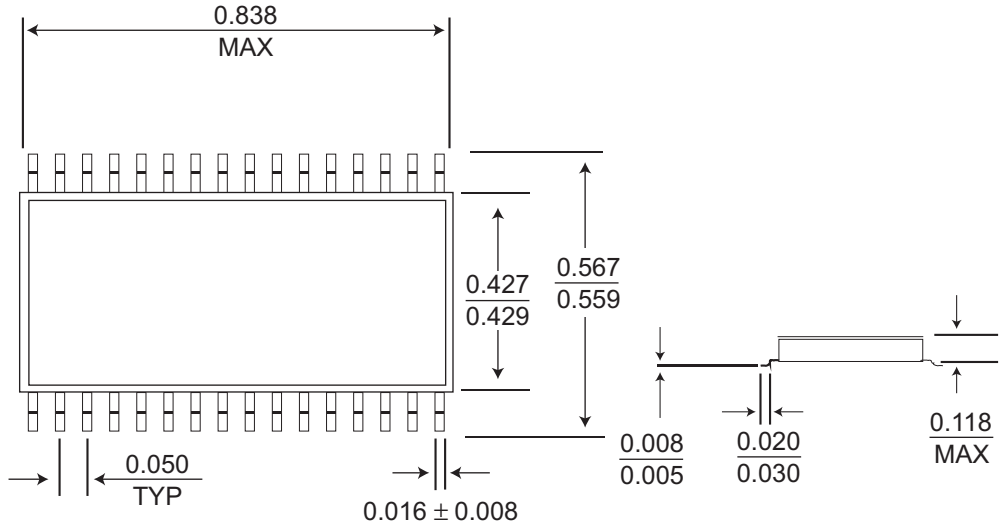

ALL LINEAR DIMENSIONS ARE MILLIMETERS AND PARENTHETICALLY IN INCHES

PACKAGE 226: 36 LEAD, CERAMIC FLAT PACK

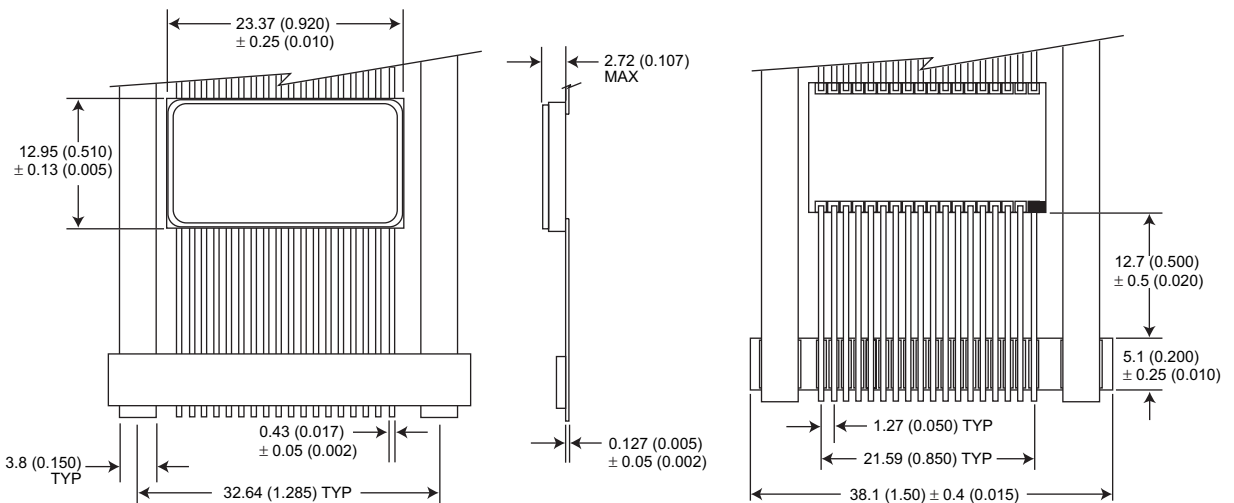

ALL LINEAR DIMENSIONS ARE MILLIMETERS AND PARENTHETICALLY IN INCHES



PACKAGE 300: 32 PIN, CERAMIC DIP, SINGLE CAVITY SIDE BRAZED

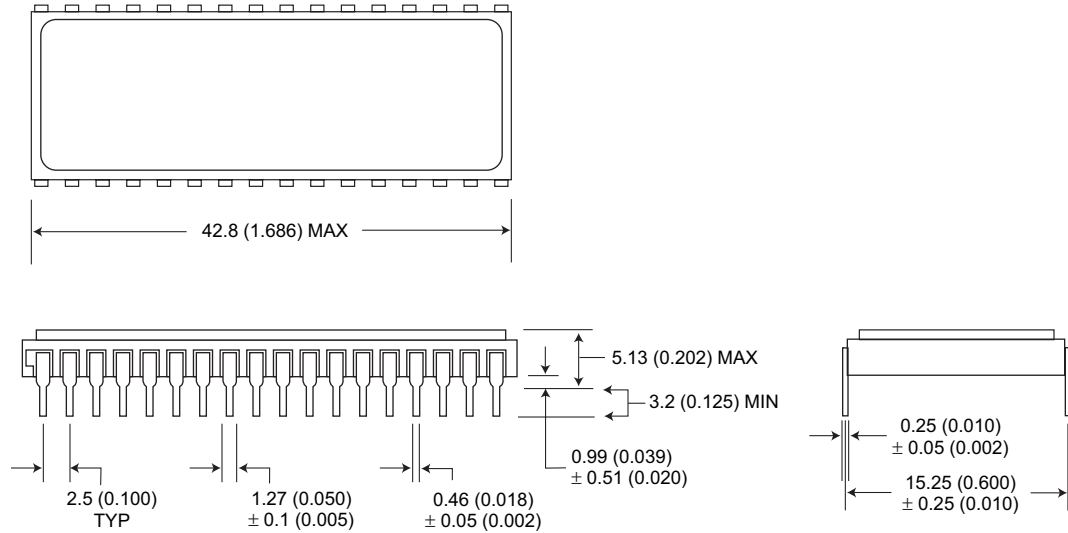

ALL LINEAR DIMENSIONS ARE MILLIMETERS AND PARENTHETICALLY IN INCHES



PACKAGE 300: 32 PIN, CERAMIC DIP, SINGLE CAVITY SIDE BRAZED

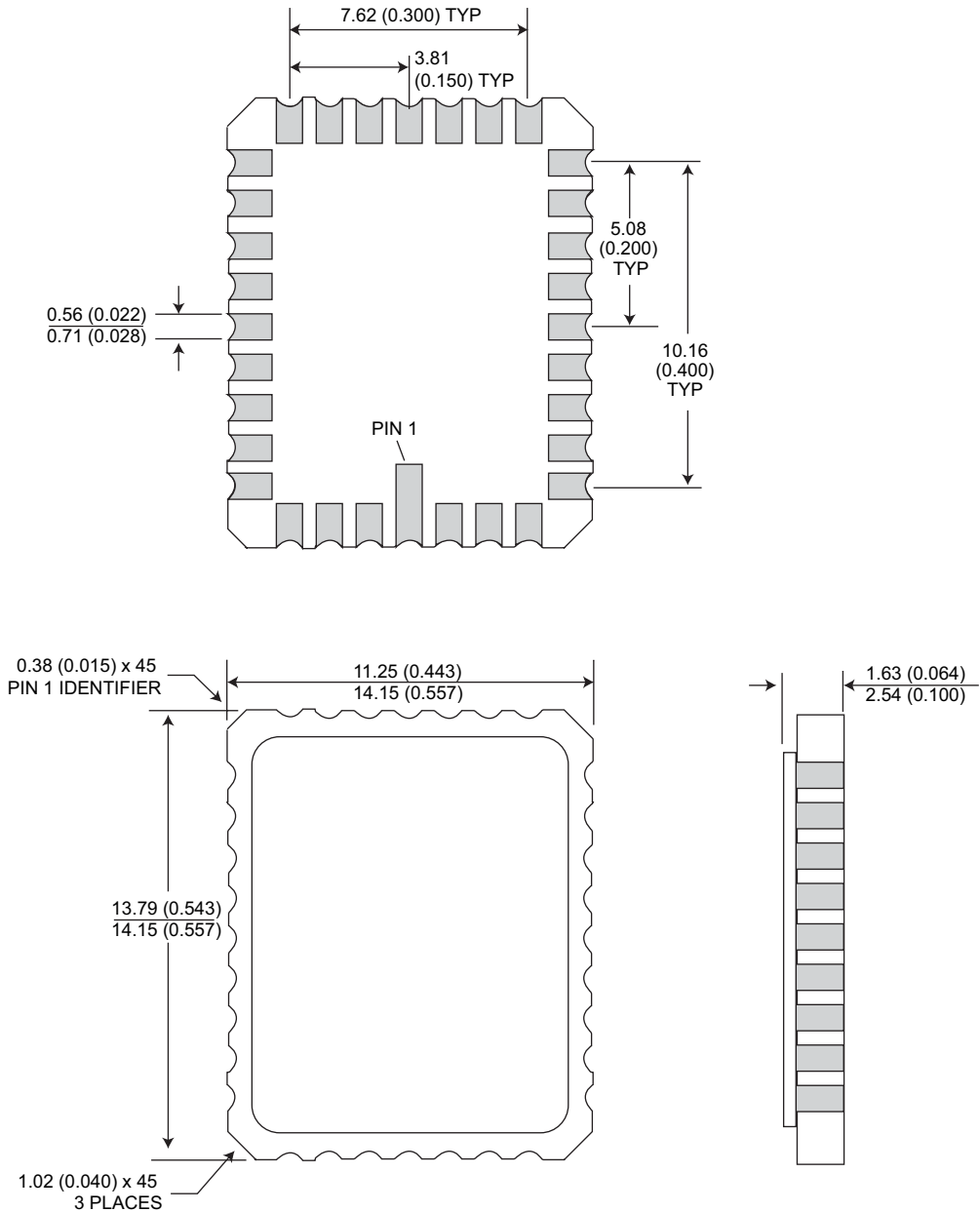

ALL LINEAR DIMENSIONS ARE MILLIMETERS AND PARENTHETICALLY IN INCHES



ORDERING INFORMATION

W M S 512K 8 X - XXX X X X

WHITE ELECTRONIC DESIGNS CORP. _____

MONOLITHIC _____

SRAM _____

ORGANIZATION, 512K X 8 _____

IMPROVEMENT MARK: _____

BLANK = STANDARD

L = LOW POWER DATA RETENTION

ACCESS TIME (NS) _____

PACKAGE: _____

C = 32 PIN CERAMIC 0.600" DIP (PACKAGE 300)

CL = 32 PIN RECTANGULAR CERAMIC LEADLESS CHIP CARRIER (PACKAGE 601)

DE = 32 LEAD CERAMIC SOJ (PACKAGE 101) EVOLUTIONARY

DJ = 36 LEAD CERAMIC SOJ (PACKAGE 100)

F = 36 LEAD CERAMIC FLAT PACK (PACKAGE 226)

FF = 32 LEAD CERAMIC THINPACK™ FLAT PACK (PACKAGE 321)

DEVICE GRADE: _____

Q = MIL-STD-883 COMPLIANT

M = MILITARY SCREENED $-55^{\circ}\text{C} \leq \text{TA} \leq 125^{\circ}\text{C}$

I = INDUSTRIAL $-40^{\circ}\text{C} \leq \text{TA} \leq 85^{\circ}\text{C}$

C = COMMERCIAL $0^{\circ}\text{C} \leq \text{TA} \leq 70^{\circ}\text{C}$

LEAD FINISH: _____

BLANK = GOLD PLATED LEADS

A = SOLDER DIP LEADS

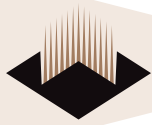

DEVICE TYPE	SPEED	PACKAGE	SMD NO.
512K x 8 SRAM Monolithic	55ns	32 pin DIP (C)	5962-95613 05HYX
512K x 8 SRAM Monolithic	45ns	32 pin DIP (C)	5962-95613 06HYX
512K x 8 SRAM Monolithic	35ns	32 pin DIP (C)	5962-95613 07HYX
512K x 8 SRAM Monolithic	25ns	32 pin DIP (C)	5962-95613 08HYX
512K x 8 SRAM Monolithic	20ns	32 pin DIP (C)	5962-95613 09HYX
512K x 8 SRAM Monolithic	17ns	32 pin DIP (C)	5962-95613 10HYX
512K x 8 SRAM Monolithic	15ns	32 pin DIP (C)	5962-95613 14HYX
512K x 8 SRAM Monolithic	55ns	32 lead SOJ Evol (DE)	5962-95613 05HTX
512K x 8 SRAM Monolithic	45ns	32 lead SOJ Evol (DE)	5962-95613 06HTX
512K x 8 SRAM Monolithic	35ns	32 lead SOJ Evol (DE)	5962-95613 07HTX
512K x 8 SRAM Monolithic	25ns	32 lead SOJ Evol (DE)	5962-95613 08HTX
512K x 8 SRAM Monolithic	20ns	32 lead SOJ Evol (DE)	5962-95613 09HTX
512K x 8 SRAM Monolithic	17ns	32 lead SOJ Evol (DE)	5962-95613 10HTX
512K x 8 SRAM Monolithic	15ns	32 lead SOJ Evol (DE)	5962-95613 14HTX
512K x 8 SRAM Monolithic	55ns	36 lead SOJ (DJ)	5962-95613 05HZX
512K x 8 SRAM Monolithic	45ns	36 lead SOJ (DJ)	5962-95613 06HZX
512K x 8 SRAM Monolithic	35ns	36 lead SOJ (DJ)	5962-95613 07HZX
512K x 8 SRAM Monolithic	25ns	36 lead SOJ (DJ)	5962-95613 08HZX
512K x 8 SRAM Monolithic	20ns	36 lead SOJ (DJ)	5962-95613 09HZX
512K x 8 SRAM Monolithic	17ns	36 lead SOJ (DJ)	5962-95613 10HZX
512K x 8 SRAM Monolithic	15ns	36 lead SOJ (DJ)	5962-95613 14HZX
512K x 8 SRAM Monolithic	55ns	36 lead Flatpack (F)	5962-95613 05HXX
512K x 8 SRAM Monolithic	45ns	36 lead Flatpack (F)	5962-95613 06HXX
512K x 8 SRAM Monolithic	35ns	36 lead Flatpack (F)	5962-95613 07HXX
512K x 8 SRAM Monolithic	25ns	36 lead Flatpack (F)	5962-95613 08HXX
512K x 8 SRAM Monolithic	20ns	36 lead Flatpack (F)	5962-95613 09HXX
512K x 8 SRAM Monolithic	17ns	36 lead Flatpack (F)	5962-95613 10HXX
512K x 8 SRAM Monolithic	15ns	36 lead Flatpack (F)	5962-95613 14HXX