

G2306

N-CHANNEL ENHANCEMENT MODE POWER MOSFET

BV _{DSS}	20V
R _{DS(ON)}	32mΩ
I _D	5.3A

Description

The G2306 utilized advanced processing techniques to achieve the lowest possible on-resistance, extremely efficient and cost-effectiveness device.

The SOT-23 package is universally used for all commercial-industrial applications.

Features

- Capable of 2.5V gate drive
- Lower on-resistance
- Reliable and Rugged

Applications

- Power Management in Notebook Computer
- Portable Equipment
- Battery Powered System.

Package Dimensions

N-Channel

Marking :

REF.	Millimeter		REF.	Millimeter	
	Min.	Max.		Min.	Max.
A	2.70	3.10	G	1.90	REF.
B	2.40	2.80	H	1.00	1.30
C	1.40	1.60	K	0.10	0.20
D	0.35	0.50	J	0.40	-
E	0	0.10	L	0.85	1.15
F	0.45	0.55	M	0°	10°

Absolute Maximum Ratings

Parameter	Symbol	Ratings	Unit
Drain-Source Voltage	V _{DS}	20	V
Gate-Source Voltage	V _{GS}	±12	V
Continuous Drain Current ³ , V _{GS} @4.5V	I _D @TA=25°C	5.3	A
Continuous Drain Current ³ , V _{GS} @4.5V	I _D @TA=70°C	4.3	A
Pulsed Drain Current ^{1,2}	I _{DM}	10	A
Power Dissipation	P _D @TA=25°C	1.38	W
Linear Derating Factor		0.01	W/°C
Operating Junction and Storage Temperature Range	T _j , T _{stg}	-55 ~ +150	°C

Thermal Data

Parameter	Symbol	Ratings	Unit
Thermal Resistance Junction-ambient ³ Max.	R _{thj-a}	90	°C/W

Electrical Characteristics(Tj = 25°C Unless otherwise specified)

Parameter	Symbol	Min.	Typ.	Max.	Unit	Test Conditions
Drain-Source Breakdown Voltage	BV_{DSS}	20	-	-	V	$V_{GS}=0, I_D=250\mu A$
Breakdown Voltage Temperature Coefficient	$\Delta BV_{DSS}/\Delta T_j$	-	0.1	-	V/°C	Reference to 25°C, $I_D=1mA$
Gate Threshold Voltage	$V_{GS(th)}$	0.5	-	1.2	V	$V_{DS}=V_{GS}, I_D=250\mu A$
Forward Transconductance	g_{fs}	-	13	-	S	$V_{DS}=5.0V, I_D=5.3A$
Gate-Source Leakage Current	I_{GSS}	-	-	±100	nA	$V_{GS}= \pm 12V$
Drain-Source Leakage Current(Tj=25°C)	I_{DSS}	-	-	1	uA	$V_{DS}=20V, V_{GS}=0$
Drain-Source Leakage Current(Tj=70°C)		-	-	10	uA	$V_{DS}=16V, V_{GS}=0$
Static Drain-Source On-Resistance	$R_{DS(on)}$	-	-	30	mΩ	$I_D=5.5A, V_{GS}=10V$
		-	-	35		$I_D=5.3A, V_{GS}=4.5V$
		-	-	50		$I_D=2.6A, V_{GS}=2.5V$
		-	-	90		$I_D=1.0A, V_{GS}=1.8V$
Total Gate Charge ²	Q_g	-	8.7	-	nC	$I_D=5.3A$
Gate-Source Charge	Q_{gs}	-	1.5	-		$V_{DS}=10V$
Gate-Drain ("Miller") Charge	Q_{gd}	-	3.6	-		$V_{GS}=4.5V$
Turn-on Delay Time ²	$T_{d(on)}$	-	6	-	ns	$V_{DS}=15V$
Rise Time	T_r	-	14	-		$I_D=1A$
Turn-off Delay Time	$T_{d(off)}$	-	18.4	-		$V_{GS}=10V$
Fall Time	T_f	-	2.8	-		$R_G=2\Omega$ $R_D=15\Omega$
Input Capacitance	C_{iss}	-	603	-	pF	$V_{GS}=0V$
Output Capacitance	C_{oss}	-	144	-		$V_{DS}=15V$
Reverse Transfer Capacitance	C_{rss}	-	111	-		$f=1.0MHz$

Source-Drain Diode

Forward On Voltage ²	V_{SD}	-	-	1.2	V	$I_S=1.2A, V_{GS}=0 T_j=25^\circ C$
Reverse Recovery Time	T_{rr}	-	16.8	-	ns	$I_S=5.0A, V_{GS}=0$
Reverse Recovery Charge	Q_{rr}	-	11	-	nC	$dI/dt=100A/\mu s$

Notes: 1. Pulse width limited by Max. junction temperature.

2. Pulse width $\leq 300\mu s$, duty cycle $\leq 2\%$.

3. Surface mounted on 1 in² copper pad of FR4 board;270°C/w when mounted on min. copper pad.

Characteristics Curve

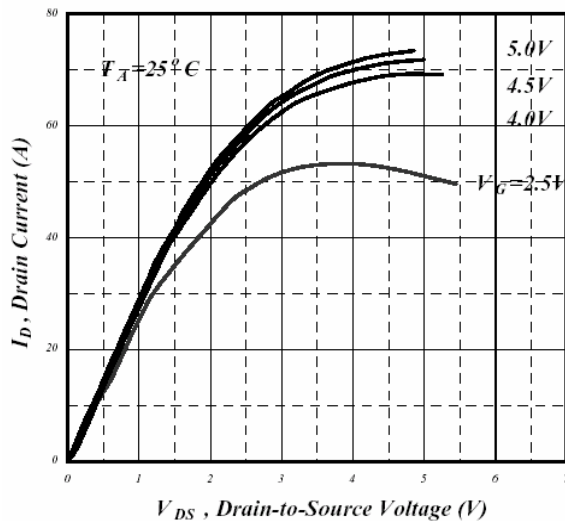

Fig 1. Typical Output Characteristics

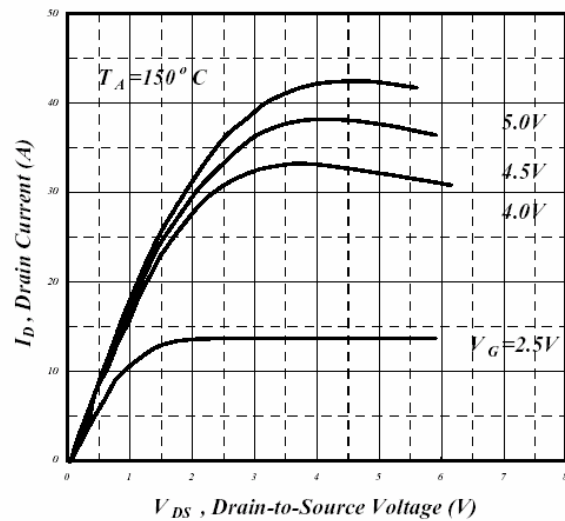

Fig 2. Typical Output Characteristics

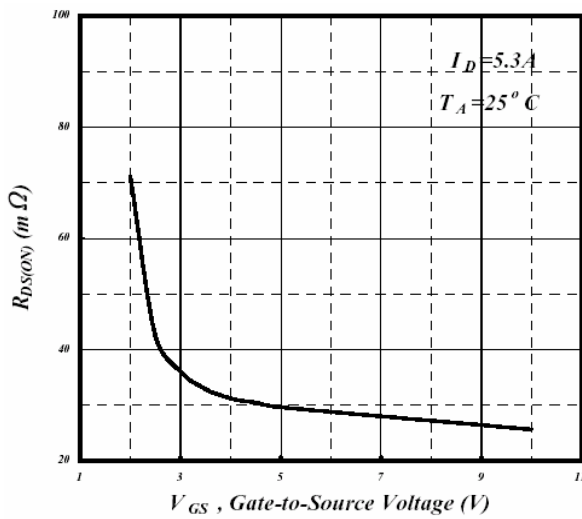

Fig 3. On-Resistance v.s. Gate Voltage

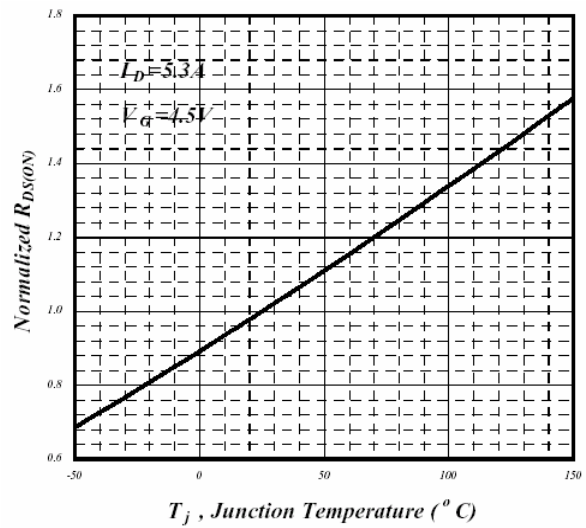

Fig 4. Normalized On-Resistance v.s. Junction Temperature

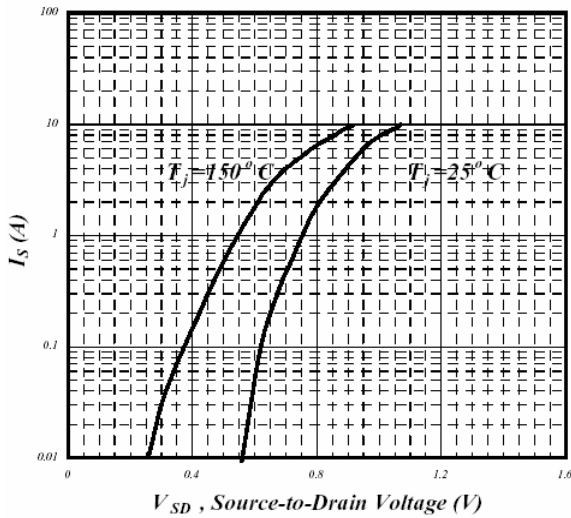

Fig 5. Forward Characteristic of Reverse Diode

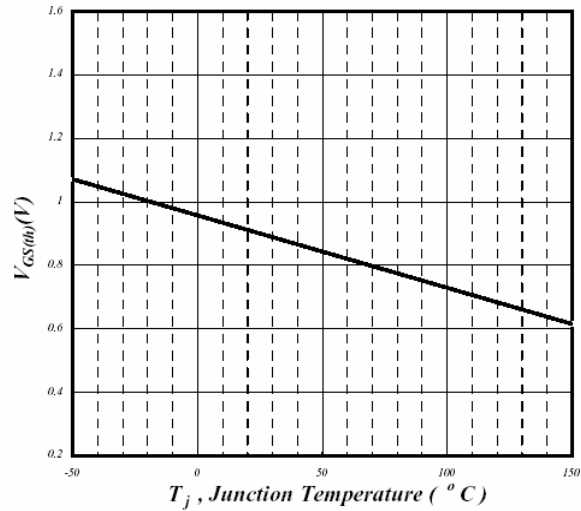

Fig 6. Gate Threshold Voltage v.s. Junction Temperature

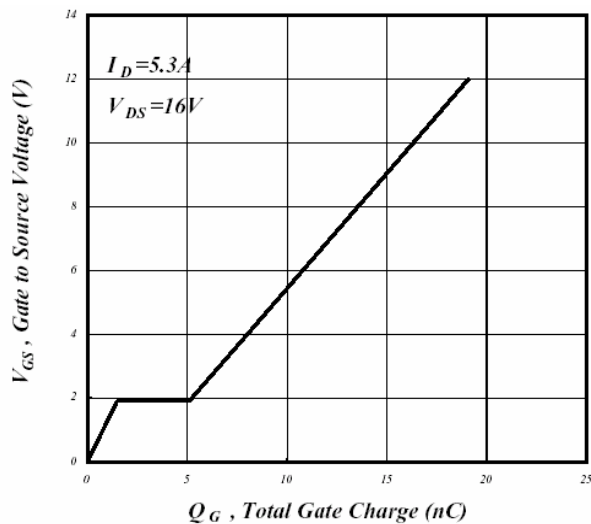

Fig 7. Gate Charge Characteristics

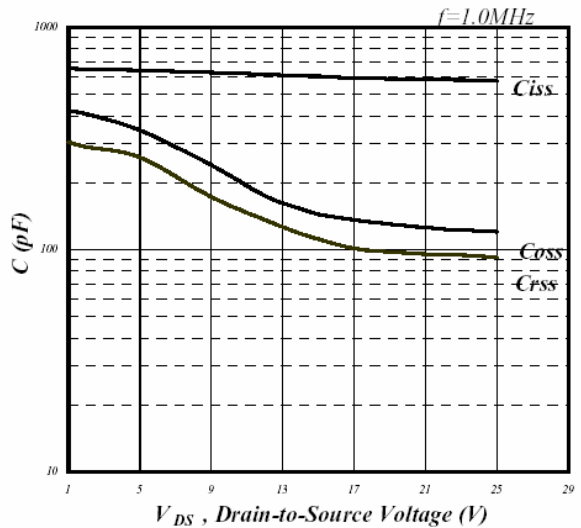

Fig 8. Typical Capacitance Characteristics

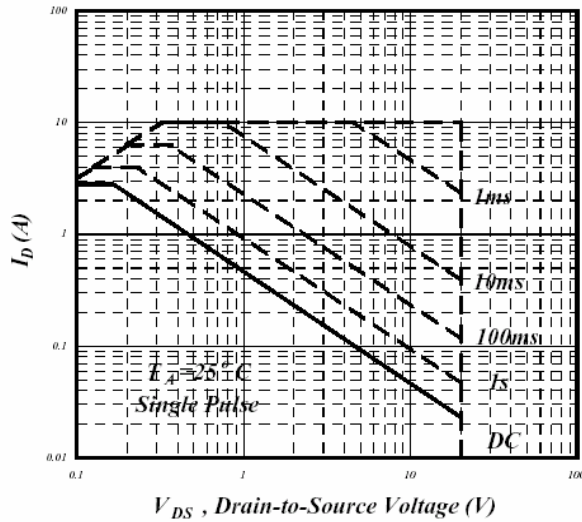

Fig 9. Maximum Safe Operating Area

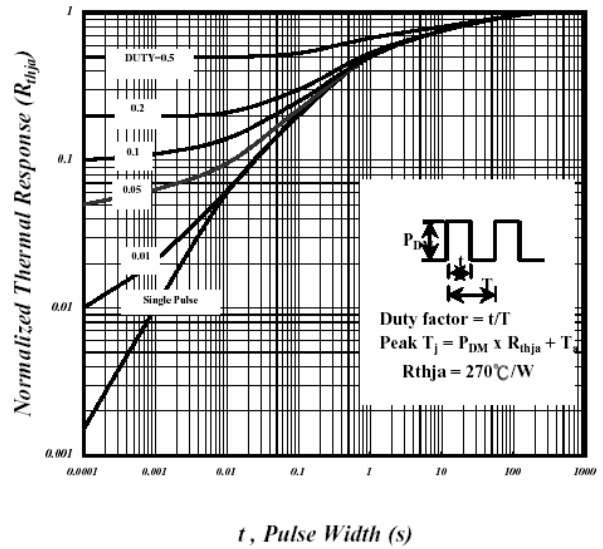

Fig10. Effective Transient Thermal Impedance

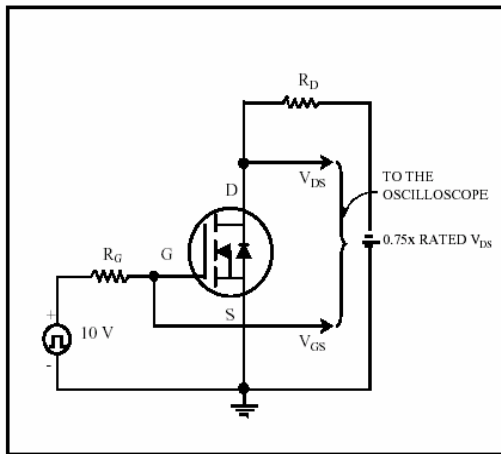

Fig 11. Switching Time Circuit

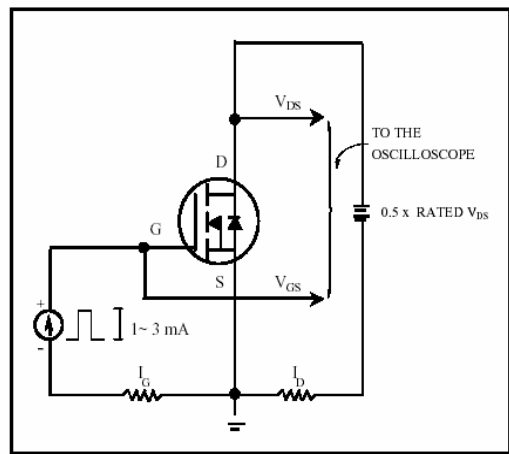

Fig 12. Gate Charge Circuit

Important Notice:

- All rights are reserved. Reproduction in whole or in part is prohibited without the prior written approval of GTM.
- GTM reserves the right to make changes to its products without notice.
- GTM semiconductor products are not warranted to be suitable for use in life-support Applications, or systems.
- GTM assumes no liability for any consequence of customer product design, infringement of patents, or application assistance.

Head Office And Factory:

- **Taiwan:** No. 17-1 Tatung Rd. Fu Kou Hsin-Chu Industrial Park, Hsin-Chu, Taiwan, R. O. C.
- TEL : 886-3-597-7061 FAX : 886-3-597-9220, 597-0785
- **China:** (201203) No.255, Jang-Jiang Tsai-Lueng RD. , Pu-Dung-Hsin District, Shang-Hai City, China
- TEL : 86-21-5895-7671 ~ 4 FAX : 86-21-38950165