

8-CHANNEL ANALOG MULTIPLEXER/DEMULTIPLEXER

FEATURES

- Wide analog input voltage range: ± 5 V.
- Low "ON" resistance:
80 Ω (typ.) at $V_{CC} - V_{EE} = 4.5$ V
70 Ω (typ.) at $V_{CC} - V_{EE} = 6.0$ V
60 Ω (typ.) at $V_{CC} - V_{EE} = 9.0$ V
- Logic level translation:
to enable 5 V logic to communicate
with ± 5 V analog signals
- Typical "break before make" built in
- Output capability: non-standard
- I_{CC} category: MSI

GENERAL DESCRIPTION

The 74HC/HCT4051 are high-speed Si-gate CMOS devices and are pin compatible with the "4051" of the "4000B" series. They are specified in compliance with JEDEC standard no. 7A.

The 74HC/HCT4051 are 8-channel analog multiplexers/demultiplexers with three digital select inputs (S_0 to S_2), an active LOW enable input (\bar{E}), eight independent inputs/outputs (Y_0 to Y_7) and a common input/output (Z).

With \bar{E} LOW, one of the eight switches is selected (low impedance ON-state) by S_0 to S_2 . With \bar{E} HIGH, all switches are in the high impedance OFF-state, independent of S_0 to S_2 .

V_{CC} and GND are the supply voltage pins for the digital control inputs (S_0 to S_2 , and \bar{E}). The V_{CC} to GND ranges are 2.0 to 10.0 V for HC and 4.5 to 5.5 V for HCT. The analog inputs/outputs (Y_0 to Y_7 , and Z) can swing between V_{CC} as a positive limit and V_{EE} as a negative limit. $V_{CC} - V_{EE}$ may not exceed 10.0 V.

For operation as a digital multiplexer/demultiplexer, V_{EE} is connected to GND (typically ground).

SYMBOL	PARAMETER	CONDITIONS	TYPICAL		UNIT
			HC	HCT	
t_{PZH}/t_{PZL}	turn "ON" time \bar{E} to V_{OS} S_n to V_{OS}	$C_L = 15$ pF $R_L = 1$ k Ω $V_{CC} = 5$ V	22 20	22 24	ns ns
t_{PHZ}/t_{PLZ}	turn "OFF" time \bar{E} to V_{OS} S_n to V_{OS}		18 19	16 20	ns ns
C_I	input capacitance		3.5	3.5	pF
C_{PD}	power dissipation capacitance per switch	notes 1 and 2	25	25	pF
C_S	max. switch capacitance independent (Y) common (Z)		5	5	pF
			25	25	pF

$V_{EE} = \text{GND} = 0$ V; $T_{amb} = 25$ °C; $t_r = t_f = 6$ ns

Notes

1. C_{PD} is used to determine the dynamic power dissipation (P_D in μ W):

$$P_D = C_{PD} \times V_{CC}^2 \times f_i + \sum \{ (C_L + C_S) \times V_{CC}^2 \times f_o \}$$
 where:

f_i = input frequency in MHz
 f_o = output frequency in MHz
 C_L = output load capacitance in pF
 C_S = max. switch capacitance in pF
 $\sum \{ (C_L + C_S) \times V_{CC}^2 \times f_o \}$ = sum of outputs
 V_{CC} = supply voltage in V

2. For HC the condition is $V_I = \text{GND}$ to V_{CC}
 For HCT the condition is $V_I = \text{GND}$ to $V_{CC} - 1.5$ V

PACKAGE OUTLINES

16-lead DIL; plastic (SOT38Z).

16-lead mini-pack; plastic (SO16; SOT109A).

PIN DESCRIPTION

PIN NO.	SYMBOL	NAME AND FUNCTION
3	Z	common input/output
6	\bar{E}	enable input (active LOW)
7	V_{EE}	negative supply voltage
8	GND	ground (0 V)
11, 10, 9	S_0 to S_2	select inputs
13, 14, 15, 12, 1, 5, 2, 4	Y_0 to Y_7	independent inputs/outputs
16	V_{CC}	positive supply voltage

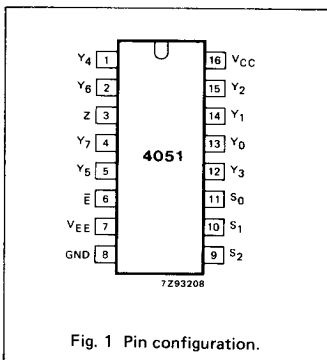

Fig. 1 Pin configuration.

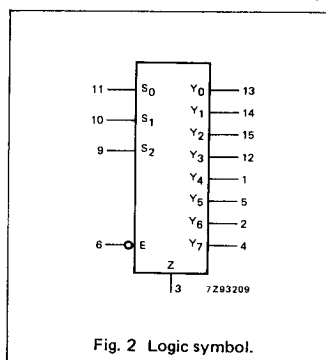

Fig. 2 Logic symbol.

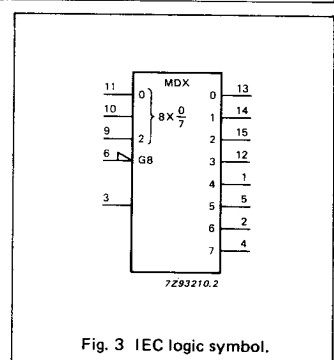

Fig. 3 IEC logic symbol.

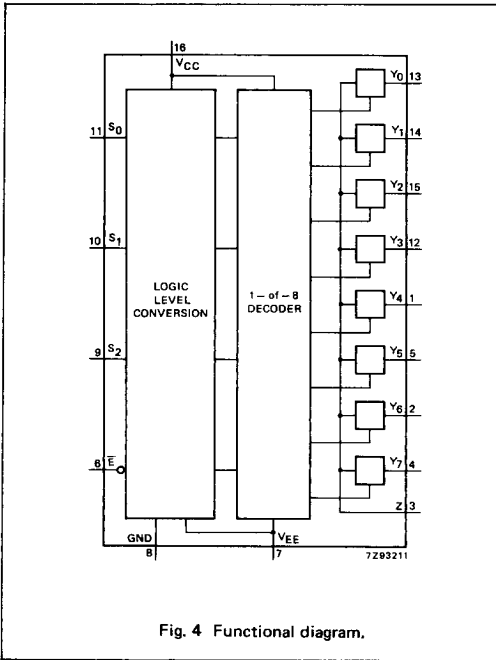

Fig. 4 Functional diagram.

APPLICATIONS

- Analog multiplexing and demultiplexing
- Digital multiplexing and demultiplexing
- Signal gating

FUNCTION TABLE

INPUTS				channel ON
\bar{E}	S ₂	S ₁	S ₀	
L	L	L	L	Y ₀ - Z
L	L	L	H	Y ₁ - Z
L	L	H	L	Y ₂ - Z
L	L	H	H	Y ₃ - Z
L	H	L	L	Y ₄ - Z
L	H	L	H	Y ₅ - Z
L	H	H	L	Y ₆ - Z
L	H	H	H	Y ₇ - Z
H	X	X	X	none

H = HIGH voltage level
L = LOW voltage level
X = don't care

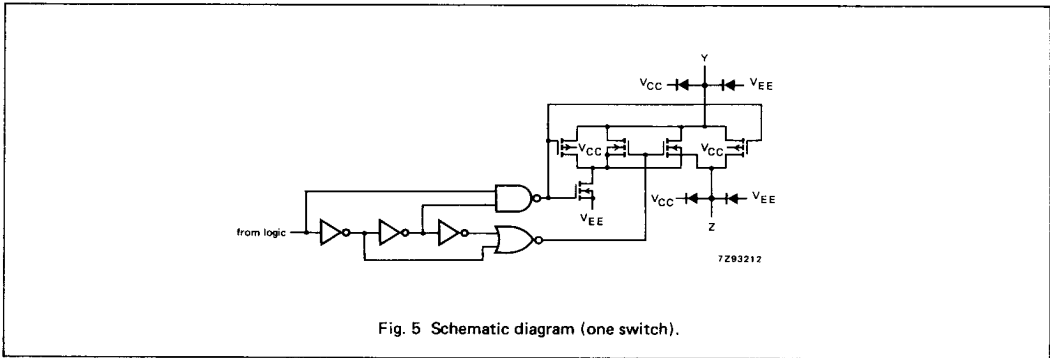

Fig. 5 Schematic diagram (one switch).

RATINGS

Limiting values in accordance with the Absolute Maximum System (IEC 134)

Voltages are referenced to $V_{EE} = \text{GND}$ (ground = 0 V)

SYMBOL	PARAMETER	MIN.	MAX.	UNIT	CONDITIONS
V_{CC}	DC supply voltage	-0.5	+11.0	V	
$\pm I_{IK}$	DC digital input diode current		20	mA	for $V_I < -0.5 \text{ V}$ or $V_I > V_{CC} + 0.5 \text{ V}$
$\pm I_{SK}$	DC switch diode current		20	mA	for $V_S < -0.5 \text{ V}$ or $V_S > V_{CC} + 0.5 \text{ V}$
$\pm I_S$	DC switch current		25	mA	for $-0.5 \text{ V} < V_S < V_{CC} + 0.5 \text{ V}$
$\pm I_{EE}$	DC V_{EE} current		20	mA	
$\pm I_{CC};$ $\pm I_{GND}$	DC V_{CC} or GND current		50	mA	
T_{stg}	storage temperature range	-65	+150	$^{\circ}\text{C}$	
P_{tot}	power dissipation per package				for temperature range: -40 to $+125 \text{ }^{\circ}\text{C}$ 74HC/HCT
	plastic DIL		750	mW	above $+70 \text{ }^{\circ}\text{C}$: derate linearly with 12 mW/K
	plastic mini-pack (SO)		500	mW	above $+70 \text{ }^{\circ}\text{C}$: derate linearly with 8 mW/K
P_S	power dissipation per switch		100	mW	

Note to ratings

To avoid drawing V_{CC} current out of terminal Z, when switch current flows in terminals Y_n , the voltage drop across the bidirectional switch must not exceed 0.4 V. If the switch current flows into terminal Z, no V_{CC} current will flow out of terminals Y_n . In this case there is no limit for the voltage drop across the switch, but the voltages at Y_n and Z may not exceed V_{CC} or V_{EE} .

RECOMMENDED OPERATING CONDITIONS

SYMBOL	PARAMETER	74HC			74HCT			UNIT	CONDITIONS
		min.	typ.	max.	min.	typ.	max.		
V_{CC}	DC supply voltage $V_{CC}-\text{GND}$	2.0	5.0	10.0	4.5	5.0	5.5	V	see Figs 6 and 7
V_{CC}	DC supply voltage $V_{CC}-V_{EE}$	2.0	5.0	10.0	2.0	5.0	10.0	V	see Figs 6 and 7
V_I	DC input voltage range	GND		V_{CC}	GND		V_{CC}	V	
V_S	DC switch voltage range	V_{EE}		V_{CC}	V_{EE}		V_{CC}	V	
T_{amb}	operating ambient temperature range	-40		+85	-40		+85	$^{\circ}\text{C}$	see DC and AC CHARACTERISTICS
T_{amb}	operating ambient temperature range	-40		+125	-40		+125	$^{\circ}\text{C}$	
t_r, t_f	input rise and fall times		6.0	1000 500 400 250		6.0	500	ns	$V_{CC} = 2.0 \text{ V}$ $V_{CC} = 4.5 \text{ V}$ $V_{CC} = 6.0 \text{ V}$ $V_{CC} = 10.0 \text{ V}$

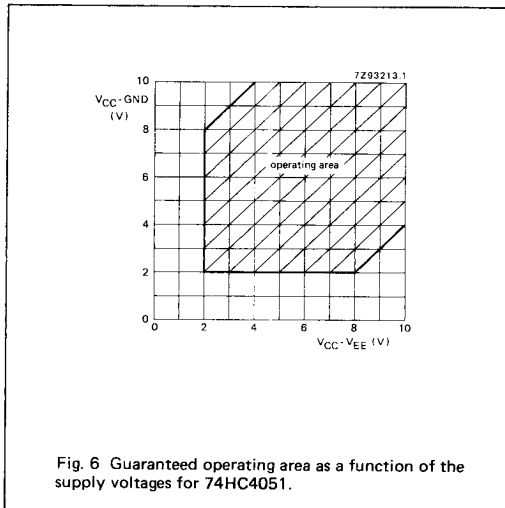

Fig. 6 Guaranteed operating area as a function of the supply voltages for 74HC4051.

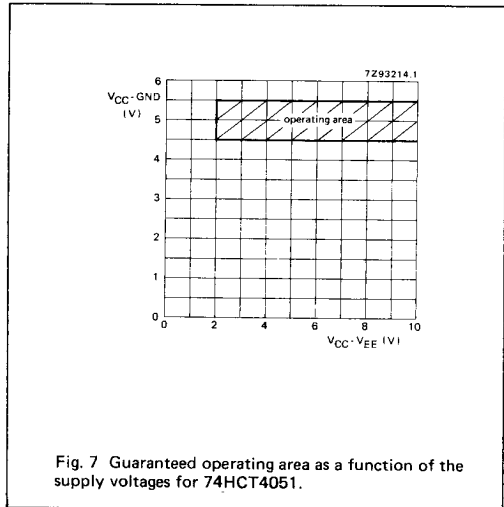

Fig. 7 Guaranteed operating area as a function of the supply voltages for 74HCT4051.

DC CHARACTERISTICS FOR 74HC/HCT

For 74HC: $V_{CC} - GND$ or $V_{CC} - V_{EE} = 2.0, 4.5, 6.0$ and 9.0 V
 For 74HCT: $V_{CC} - GND = 4.5$ and 5.5 V; $V_{CC} - V_{EE} = 2.0, 4.5, 6.0$ and 9.0 V

SYMBOL	PARAMETER	T _{amb} (°C)						UNIT	TEST CONDITIONS				
		74HC/HCT							V _{CC} V	V _{EE} V	I _S μA	V _{is}	V _I
		+25			-40 to +85		-40 to +125						
		min.	typ.	max.	min.	max.	min.		max.				
R _{ON}	ON resistance (peak)	—	—	—	—	—	—	Ω	2.0	0	100	V _{CC} to V _{EE}	V _{IH} or V _{IL}
		100	180	—	225	—	270	Ω	4.5	0	1000		
		90	160	—	200	—	240	Ω	6.0	0	1000		
R _{ON}	ON resistance (rail)	70	130	—	165	—	195	Ω	4.5	-4.5	1000	V _{EE}	V _{IH} or V _{IL}
		150	—	—	—	—	—	Ω	2.0	0	100		
		80	140	—	175	—	210	Ω	4.5	0	1000		
R _{ON}	ON resistance (rail)	70	120	—	150	—	180	Ω	6.0	0	1000	V _{CC}	V _{IH} or V _{IL}
		60	105	—	130	—	160	Ω	4.5	-4.5	1000		
		150	—	—	—	—	—	Ω	2.0	0	100		
ΔR _{ON}	maximum ΔON resistance between any two channels	90	160	—	200	—	240	Ω	2.0	0	1000	V _{CC} to V _{EE}	V _{IH} or V _{IL}
		80	140	—	175	—	210	Ω	4.5	0	1000		
		65	120	—	150	—	180	Ω	6.0	0	1000		
ΔR _{ON}	maximum ΔON resistance between any two channels	—	—	—	—	—	—	Ω	2.0	0	—	V _{CC} to V _{EE}	V _{IH} or V _{IL}
		9	—	—	—	—	—	Ω	4.5	0	—		
		8	—	—	—	—	—	Ω	6.0	0	—		
ΔR _{ON}	maximum ΔON resistance between any two channels	6	—	—	—	—	—	Ω	4.5	-4.5	—	V _{CC} to V _{EE}	V _{IH} or V _{IL}

Notes to DC characteristics

- At supply voltages ($V_{CC} - V_{EE}$) approaching 2.0 V the analog switch ON-resistance becomes extremely non-linear. Therefore it is recommended that these devices be used to transmit digital signals only, when using these supply voltages.
- For test circuit measuring R_{ON} see Fig. 8.

DC CHARACTERISTICS FOR 74HC

Voltages are referenced to GND (ground = 0 V)

SYMBOL	PARAMETER	T _{amb} (°C)						UNIT	TEST CONDITIONS				
		74HC							V _{CC} V	V _{EE} V	V _I	OTHER	
		+25			-40 to +85		-40 to +125						
		min.	typ.	max.	min.	max.	min.						max.
V _{IH}	HIGH level input voltage	1.5 3.15 4.2 6.3	1.2 2.4 3.2 4.7		1.5 3.15 4.2 6.3		1.5 3.15 4.2 6.3	V	2.0 4.5 6.0 9.0				
V _{IL}	LOW level input voltage		0.8 2.1 2.8 4.3	0.5 1.35 1.8 2.7		0.5 1.35 1.8 2.7		0.5 1.35 1.8 2.7	V	2.0 4.5 6.0 9.0			
±I _I	input leakage current			0.1 0.2		1.0 2.0		1.0 2.0	μA	6.0 10.0	0 0	V _{CC} or GND	
±I _S	analog switch OFF-state current per channel			0.1		1.0		1.0	μA	10.0	0	V _{IH} or V _{IL}	V _S = V _{CC} - V _{EE} (see Fig. 10)
±I _S	analog switch OFF-state current all channels			0.4		4.0		4.0	μA	10.0	0	V _{IH} or V _{IL}	V _S = V _{CC} - V _{EE} (see Fig. 10)
±I _S	analog switch ON-state current			0.4		4.0		4.0	μA	10.0	0	V _{IH} or V _{IL}	V _S = V _{CC} - V _{EE} (see Fig. 11)
I _{CC}	quiescent supply current			8.0 16.0		80.0 160.0		160.0 320.0	μA	6.0 10.0	0 0	V _{CC} or GND	V _{is} = V _{EE} or V _{CC} ; V _{os} = V _{CC} or V _{EE}

AC CHARACTERISTICS FOR 74HC

GND = 0 V; $t_r = t_f = 6$ ns; $C_L = 50$ pF

SYMBOL	PARAMETER	T_{amb} (°C)						UNIT	TEST CONDITIONS			
		74HC							V_{CC} V	V_{EE} V	OTHER	
		+25			-40 to +85		-40 to +125					
		min.	typ.	max.	min.	max.	min.		max.			
t _{PHL} / t _{PLH}	propagation delay V_{is} to V_{Os}		14	60		75		90	ns	2.0	0	$R_L = \infty$; $C_L = 50$ pF (see Fig. 17)
			5	12		15		18		4.5	0	
			4	10		13		15		6.0	0	
			4	8		10		12		4.5	-4.5	
t _{PZH} / t _{PZL}	turn "ON" time \bar{E} to V_{Os}		72	345		430		520	ns	2.0	0	$R_L = 1$ k Ω ; $C_L = 50$ pF (see Figs 18, 19 and 20)
			29	69		86		104		4.5	0	
			21	59		73		88		6.0	0	
			18	51		64		77		4.5	-4.5	
t _{PZH} / t _{PZL}	turn "ON" time S_n to V_{Os}		66	345		430		520	ns	2.0	0	$R_L = 1$ k Ω ; $C_L = 50$ pF (see Figs 18, 19 and 20)
			28	69		86		104		4.5	0	
			19	59		73		88		6.0	0	
			16	51		64		77		4.5	-4.5	
t _{PHZ} / t _{PLZ}	turn "OFF" time \bar{E} to V_{Os}		58	290		365		435	ns	2.0	0	$R_L = 1$ k Ω ; $C_L = 50$ pF (see Figs 18, 19 and 20)
			31	58		73		87		4.5	0	
			17	49		62		74		6.0	0	
			18	42		53		72		4.5	-4.5	
t _{PHZ} / t _{PLZ}	turn "OFF" time S_n to V_{Os}		61	290		365		435	ns	2.0	0	$R_L = 1$ k Ω ; $C_L = 50$ pF (see Figs 18, 19 and 20)
			25	58		73		87		4.5	0	
			18	49		62		74		6.0	0	
			18	42		53		72		4.5	-4.5	

DC CHARACTERISTICS FOR 74HCT

Voltages are referenced to GND (ground = 0)

SYMBOL	PARAMETER	T _{amb} (°C)						UNIT	TEST CONDITIONS				
		74HCT							V _{CC} V	V _{EE} V	V _I	OTHER	
		+25			-40 to +85		-40 to +125						
		min.	typ.	max.	min.	max.	min.						max.
V _{IH}	HIGH level input voltage	2.0	1.6		2.0		2.0		V	4.5 to 5.5			
V _{IL}	LOW level input voltage		1.2	0.8		0.8		0.8	V	4.5 to 5.5			
±I _I	input leakage current			0.1		1.0		1.0	μA	5.5	0	V _{CC} or GND	
±I _S	analog switch OFF-state current per channel			0.1		1.0		1.0	μA	10.0	0	V _{IH} or V _{IL}	V _S = V _{CC} - V _{EE} (see Fig. 10)
±I _S	analog switch OFF-state current all channels			0.4		4.0		4.0	μA	10.0	0	V _{IH} or V _{IL}	V _S = V _{CC} - V _{EE} (see Fig. 10)
±I _S	analog switch ON-state current			0.4		4.0		4.0	μA	10.0	0	V _{IH} or V _{IL}	V _S = V _{CC} - V _{EE} (see Fig. 11)
I _{CC}	quiescent supply current			8.0 16.0		80.0 160.0		160.0 320.0	μA	5.5 5.0	0 -5.0	V _{CC} or GND	V _{is} = V _{EE} or V _{CC} ; V _{os} = V _{CC} or V _{EE}
ΔI _{CC}	additional quiescent supply current per input pin for unit load coefficient is 1 (note 1)		100	360		450		490	μA	4.5 to 5.5	0	V _{CC} -2.1V	other inputs at V _{CC} or GND

Note to HCT types

1. The value of additional quiescent supply current (ΔI_{CC}) for a unit load of 1 is given here.To determine ΔI_{CC} per input, multiply this value by the unit load coefficient shown in the table below.

INPUT	UNIT LOAD COEFFICIENT
S _n	0.50
E	0.50

AC CHARACTERISTICS FOR 74HCT

GND = 0 V; $t_r = t_f = 6$ ns; $C_L = 50$ pF

SYMBOL	PARAMETER	T _{amb} (°C)						UNIT	TEST CONDITIONS		
		74HCT							V _{CC} V	V _{EE} V	OTHER
		+25			-40 to +85		-40 to +125				
		min.	typ.	max.	min.	max.	min.		max.		
t _{PHL} / t _{PLH}	propagation delay V _{is} to V _{os}	5 4	12 8		15 10		18 12	ns	4.5 4.5	0	R _L = ∞; C _L = 50 pF (see Fig. 17)
t _{PZH} / t _{PZL}	turn "ON" time E̅ to V _{os}	26 16	55 39		69 49		83 59	ns	4.5 4.5	0 -4.5	R _L = 1 kΩ; C _L = 50 pF (see Figs 18, 19 and 20)
t _{PZH} / t _{PZL}	turn "ON" time S _n to V _{os}	28 16	55 39		69 49		83 59	ns	4.5 4.5	0 -4.5	R _L = 1 kΩ; C _L = 50 pF (see Figs 18, 19 and 20)
t _{PHZ} / t _{PLZ}	turn "OFF" time E̅ to V _{os}	19 16	45 32		56 40		68 48	ns	4.5 4.5	0 -4.5	R _L = 1 kΩ; C _L = 50 pF (see Figs 18, 19 and 20)
t _{PHZ} / t _{PLZ}	turn "OFF" time S _n to V _{os}	23 16	45 32		56 40		68 48	ns	4.5 4.5	0 -4.5	R _L = 1 kΩ; C _L = 50 pF (see Figs 18, 19 and 20)

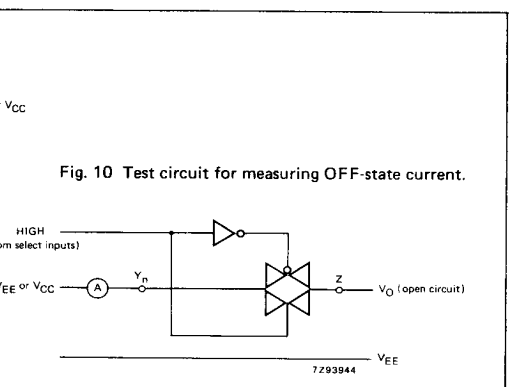
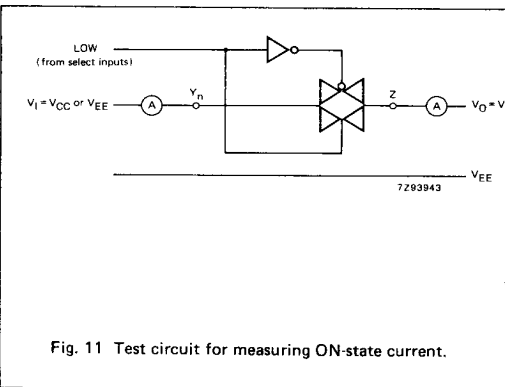
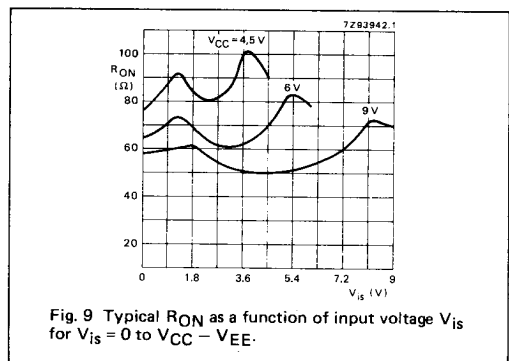
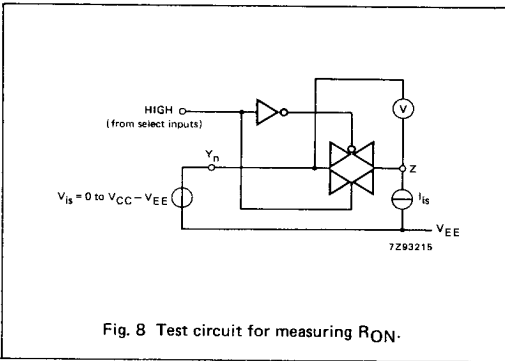

ADDITIONAL AC CHARACTERISTICS FOR 74HC/HCT

Recommended conditions and typical values

GND = 0 V; $T_{amb} = 25\text{ }^{\circ}\text{C}$

SYMBOL	PARAMETER	typ.	UNIT	V_{CC} V	V_{EE} V	$V_{is(p-p)}$ V	CONDITIONS
	sine-wave distortion $f = 1\text{ kHz}$	0.04 0.02	% %	2.25 4.5	-2.25 -4.5	4.0 8.0	$R_L = 10\text{ k}\Omega$; $C_L = 50\text{ pF}$ (see Fig. 14)
	sine-wave distortion $f = 10\text{ kHz}$	0.12 0.06	% %	2.25 4.5	-2.25 -4.5	4.0 8.0	$R_L = 10\text{ k}\Omega$; $C_L = 50\text{ pF}$ (see Fig. 14)
	switch "OFF" signal feed-through	-50 -50	dB dB	2.25 4.5	-2.25 -4.5	note 1	$R_L = 600\text{ }\Omega$; $C_L = 50\text{ pF}$ (see Figs 12 and 15)
$V_{(p-p)}$	crosstalk voltage between control and any switch (peak-to-peak value)	110 220	mV mV	4.5 4.5	0 -4.5		$R_L = 600\text{ }\Omega$; $C_L = 50\text{ pF}$; $f = 1\text{ MHz}$ (E or S_n , square-wave between V_{CC} and GND, $t_r = t_f = 6\text{ ns}$) (see Fig. 16)
f_{max}	minimum frequency response (-3dB)	170 180	MHz MHz	2.25 4.5	-2.25 -4.5	note 2	$R_L = 50\text{ }\Omega$; $C_L = 10\text{ pF}$ (see Figs 13 and 14)
C_S	maximum switch capacitance independent (Y) common (Z)	5 25	pF pF				

Notes to AC characteristics

General note

V_{is} is the input voltage at a Y_n or Z terminal, whichever is assigned as an input.
 V_{os} is the output voltage at a Y_n or Z terminal, whichever is assigned as an output.

Notes

1. Adjust input voltage V_{is} to 0 dBm level (0 dBm = 1 mW into 600 Ω).
2. Adjust input voltage V_{is} to 0 dBm level at V_{os} for 1 MHz (0 dBm = 1 mW into 50 Ω).

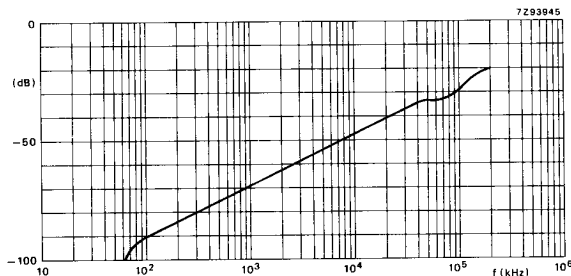
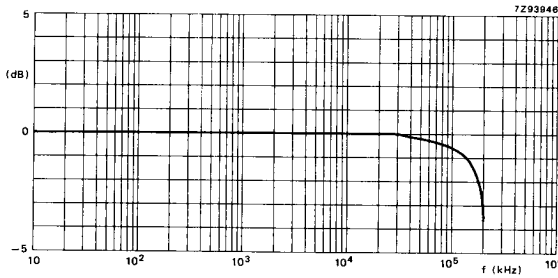

Fig. 12 Typical switch "OFF" signal feed-through as a function of frequency.



Note to Figs 12 and 13

Test conditions:
 $V_{CC} = 4.5 \text{ V}$; $GND = 0 \text{ V}$; $V_{EE} = -4.5 \text{ V}$;
 $R_L = 50 \Omega$; $R_{source} = 1 \text{ k}\Omega$

Fig. 13 Typical frequency response.

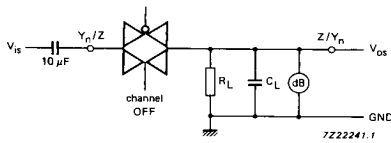

Fig. 14 Test circuit for measuring sine-wave distortion and minimum frequency response.

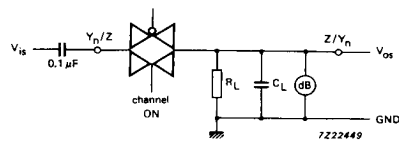

Fig. 15 Test circuit for measuring switch "OFF" signal feed-through.

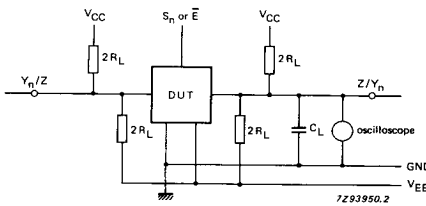
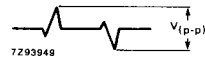

Fig. 16 Test circuit for measuring crosstalk between control and any switch.

Note to Fig. 16

The crosstalk is defined as follows (oscilloscope output):



AC WAVEFORMS

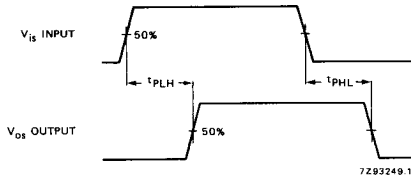

Fig. 17 Waveforms showing the input (V_{ig}) to output (V_{og}) propagation delays.

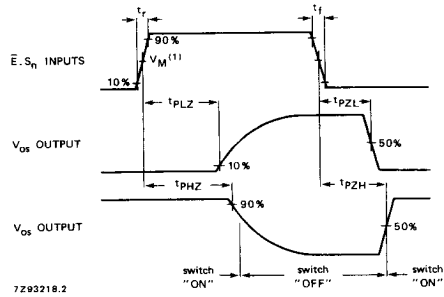

Fig. 18 Waveforms showing the turn-ON and turn-OFF times.

Note to Fig. 18

- (1) HC : $V_M = 50\%$; $V_I = \text{GND to } V_{CC}$;
- HCT: $V_M = 1.3 \text{ V}$; $V_I = \text{GND to } 3 \text{ V}$.

TEST CIRCUIT AND WAVEFORMS

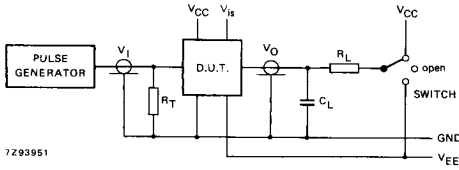

Fig. 19 Test circuit for measuring AC performance.

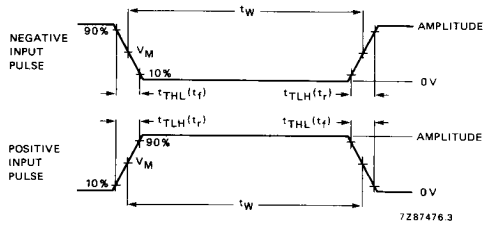

Fig. 20 Input pulse definitions.

Conditions

TEST	SWITCH	V _{is}
t _{PZH}	V _{EE}	V _{CC}
t _{PZL}	V _{CC}	V _{EE}
t _{PHZ}	V _{EE}	V _{CC}
t _{PLZ}	V _{CC}	V _{EE}
others	open	V _{EE} pulse

FAMILY	AMPLITUDE	V _M	t _r ; t _f	
			t _r ^{max} ; PULSE WIDTH	OTHER
74HC	V _{CC}	50%	< 2 ns	6 ns
74HCT	3.0 V	1.3 V	< 2 ns	6 ns

Definitions for Figs 19 and 20:

C_L = load capacitance including jig and probe capacitance (see AC CHARACTERISTICS for values).

R_T = termination resistance should be equal to the output impedance Z_O of the pulse generator.

t_r = t_f = 6 ns; when measuring f_{max}, there is no constraint to t_r, t_f with 50% duty factor.