

**N-Channel Enhancement Mode Power MOSFET**

# MTN9240J3

<b>BV<sub>DSS</sub></b>	<b>100V</b>
<b>I<sub>D</sub></b>	<b>33A</b>
<b>R<sub>DS(ON)</sub>@ V<sub>GS</sub>=10V, I<sub>D</sub>=25A</b>	<b>36m Ω (typ)</b>
<b>R<sub>DS(ON)</sub>@ V<sub>GS</sub>=5V, I<sub>D</sub>=25A</b>	<b>38m Ω (typ)</b>
<b>R<sub>DS(ON)</sub>@ V<sub>GS</sub>=4.5V, I<sub>D</sub>=25A</b>	<b>39m Ω (typ)</b>

**Features**

- Simple Drive Requirement
- Repetitive Avalanche Rated
- Fast Switching Characteristic
- RoHS compliant package

**Symbol**

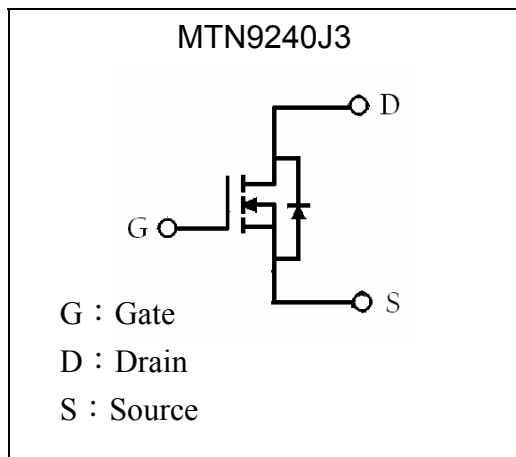

**Outline**

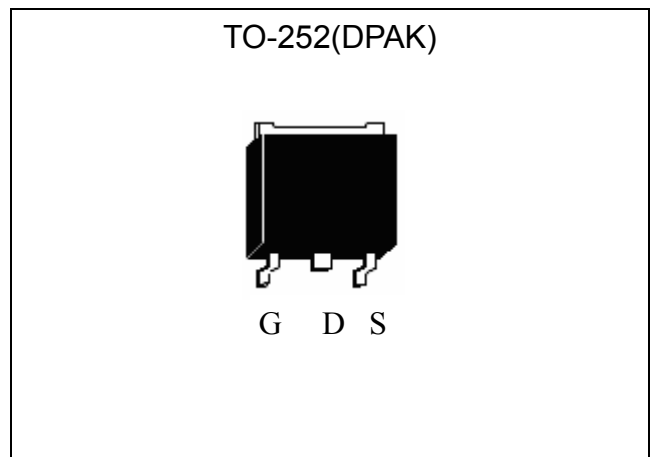

**Ordering Information**

Device	Package	Shipping
MTN9240J3-0-T3-G	TO-252 (Pb-free lead plating and halogen-free package)	2500 pcs / Tape & Reel

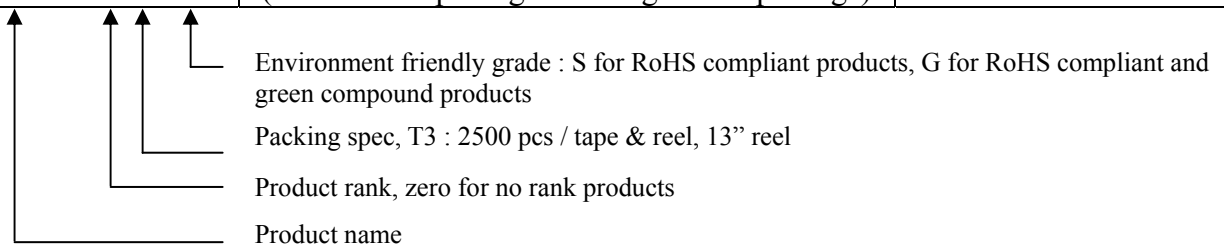



**Absolute Maximum Ratings** (Tc=25°C, unless otherwise noted)

Parameter	Symbol	Limits	Unit
Drain-Source Voltage	V <sub>DS</sub>	100	V
Gate-Source Voltage	V <sub>GS</sub>	±20	
Continuous Drain Current @ Tc=25°C, V <sub>GS</sub> =10V	I <sub>D</sub>	33	A
Continuous Drain Current @ Tc=100°C, V <sub>GS</sub> =10V		23	
Pulsed Drain Current (Note 1)	I <sub>DM</sub>	90	
Avalanche Current	I <sub>AS</sub>	32	
Avalanche Energy @ L=0.3mH, I <sub>D</sub> =32A, R <sub>G</sub> =25 Ω	E <sub>AS</sub>	154	mJ
Repetitive Avalanche Energy @ L=0.05mH (Note 2)	E <sub>AR</sub>	9	
Total Power Dissipation @ Tc=25°C	P <sub>d</sub>	115	W
Total Power Dissipation @ Tc=100°C		57.5	
Operating Junction and Storage Temperature Range	T <sub>j</sub> , T <sub>stg</sub>	-55~+175	°C

Note : 1. Pulse width limited by maximum junction temperature.  
 2. Duty cycle ≤ 1%.

**Thermal Data**

Parameter	Symbol	Value	Unit
Thermal Resistance, Junction-to-case, max	R <sub>th,j-c</sub>	1.3	°C/W
Thermal Resistance, Junction-to-ambient, max	R <sub>th,j-a</sub>	50 (Note)	
Thermal Resistance, Junction-to-ambient, max	R <sub>th,j-a</sub>	110	

Note : When mounted on the minimum pad size recommended (PCB mount).

**Characteristics (Tc=25°C, unless otherwise specified)**

Symbol	Min.	Typ.	Max.	Unit	Test Conditions
<b>Static</b>					
BV <sub>DSS</sub>	100	-	-	V	V <sub>GS</sub> =0V, I <sub>D</sub> =250μA
V <sub>GS(th)</sub>	1	1.4	2	V	V <sub>DS</sub> = V <sub>GS</sub> , I <sub>D</sub> =250μA
I <sub>GSS</sub>	-	-	±100	nA	V <sub>GS</sub> =±20, V <sub>DS</sub> =0V
I <sub>DSS</sub>	-	-	1	μA	V <sub>DS</sub> =100V, V <sub>GS</sub> =0V
	-	-	25		V <sub>DS</sub> =80V, V <sub>GS</sub> =0V, T <sub>j</sub> =125°C
*R <sub>DS(ON)</sub>	-	36	45	mΩ	V <sub>GS</sub> =10V, I <sub>D</sub> =25A
	-	38	45		V <sub>GS</sub> =5V, I <sub>D</sub> =25A
	-	39	50		V <sub>GS</sub> =4.5V, I <sub>D</sub> =25A
*G <sub>FS</sub>	-	24	-	S	V <sub>DS</sub> =10V, I <sub>D</sub> =20A
<b>Dynamic</b>					
*Q <sub>g</sub>	-	21	-	nC	V <sub>DS</sub> =80V, I <sub>D</sub> =25A, V <sub>GS</sub> =10V
*Q <sub>GS</sub>	-	3	-		
*Q <sub>gd</sub>	-	10	-		

*td(ON)	-	11	-	ns	V <sub>DS</sub> =50V, I <sub>D</sub> =1A, V <sub>GS</sub> =10V, R <sub>GS</sub> =6Ω
*tr	-	34	-		
*td(OFF)	-	62	-		
*tf	-	32	-		
Ciss	-	1180	-	pF	V <sub>GS</sub> =0V, V <sub>DS</sub> =25V, f=1MHz
Coss	-	114	-		
Crss	-	60	-		
<b>Source-Drain Diode</b>					
*I <sub>S</sub>	-	-	33	A	
*I <sub>SM</sub>	-	-	90		
*V <sub>SD</sub>	-	0.88	1.2	V	I <sub>F</sub> =25A, V <sub>GS</sub> =0V
*trr	-	56	-	ns	I <sub>F</sub> =25A, V <sub>GS</sub> =0, dI <sub>F</sub> /dt=100A/μs
*Q <sub>rr</sub>	-	230	-	nC	

\*Pulse Test : Pulse Width ≤300μs, Duty Cycle ≤2%

### Recommended soldering footprint

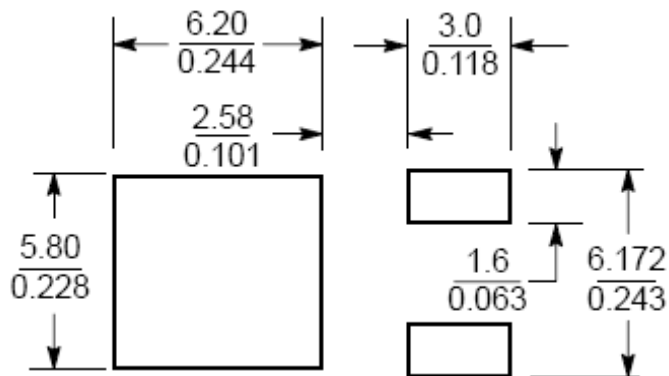

Unit (  $\frac{\text{mm}}{\text{inch}}$  )



**Typical Characteristics**

Typical Output Characteristics

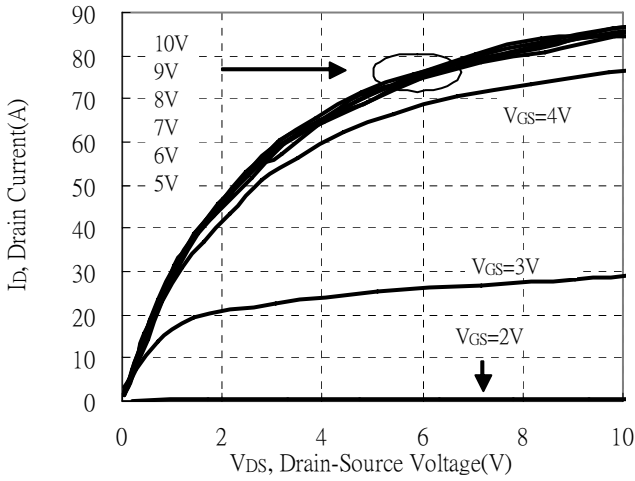

Brekdown Voltage vs Ambient Temperature

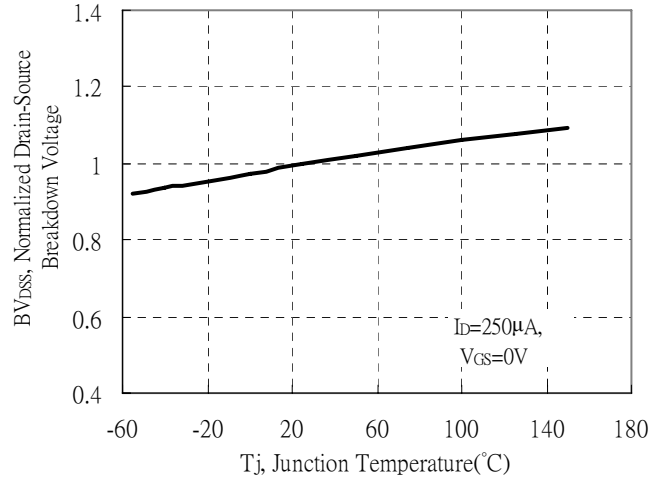

Static Drain-Source On-State resistance vs Drain Current

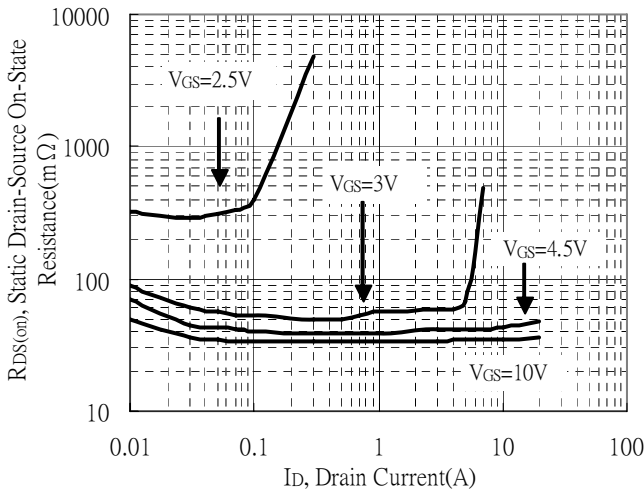

Reverse Drain Current vs Source-Drain Voltage

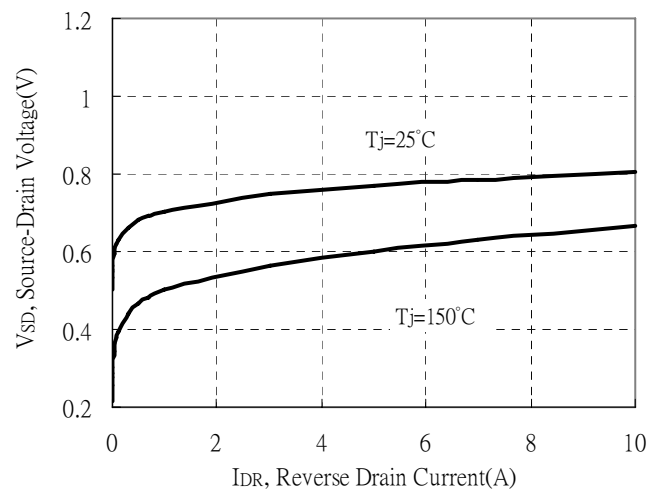

Static Drain-Source On-State Resistance vs Gate-Source Voltage

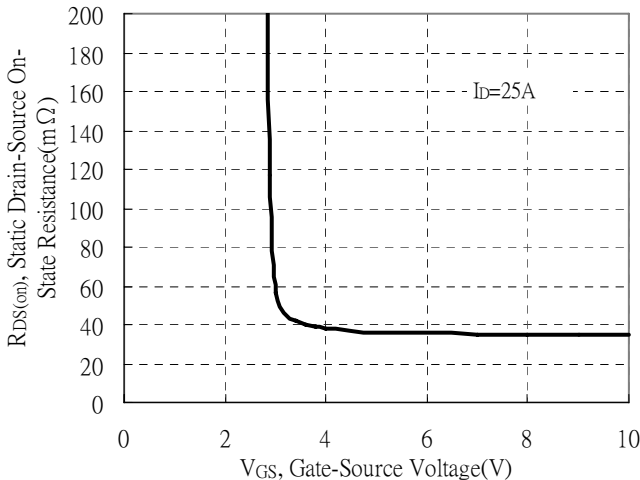

Drain-Source On-State Resistance vs Junction Temperature

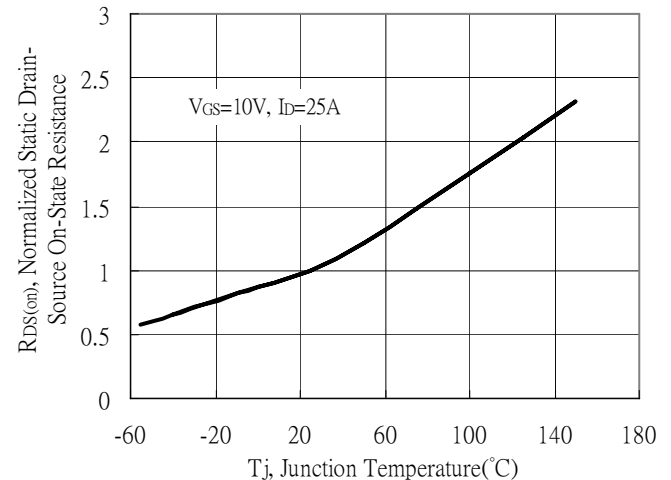

**Typical Characteristics(Cont.)**

Capacitance vs Drain-to-Source Voltage

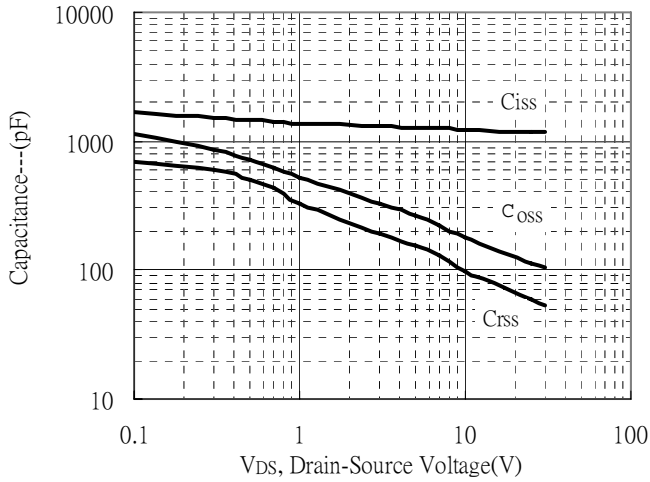

Threshold Voltage vs Junction Temperature

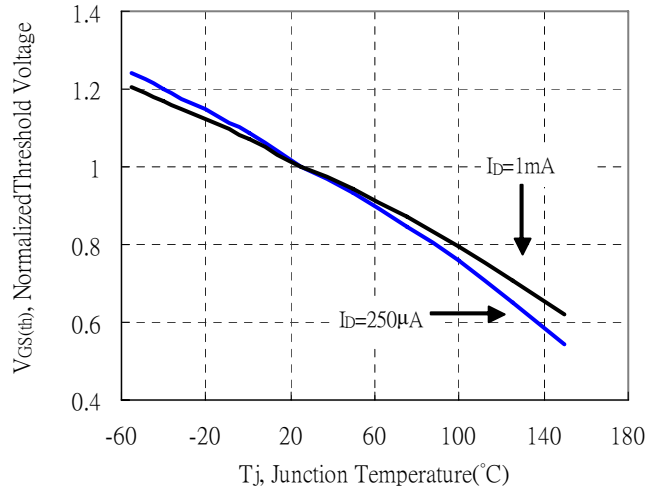

Forward Transfer Admittance vs Drain Current

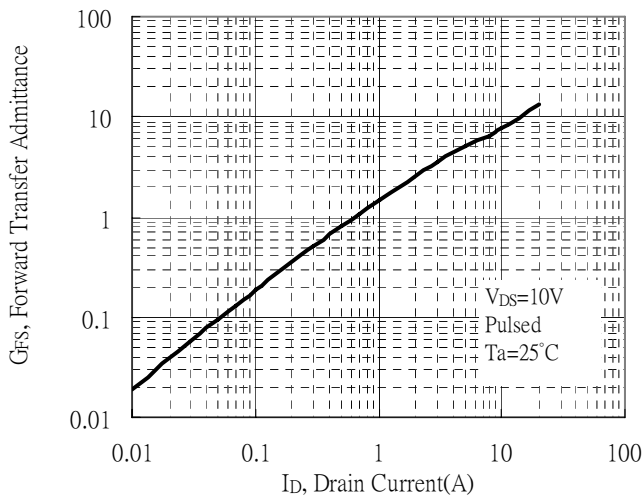

Gate Charge Characteristics

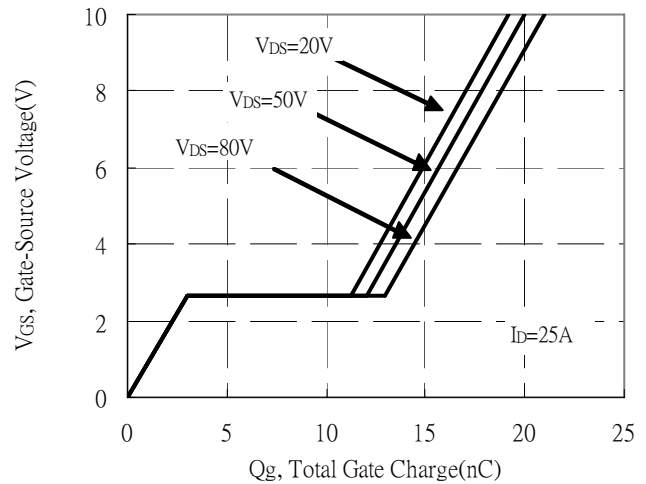

Maximum Safe Operating Area

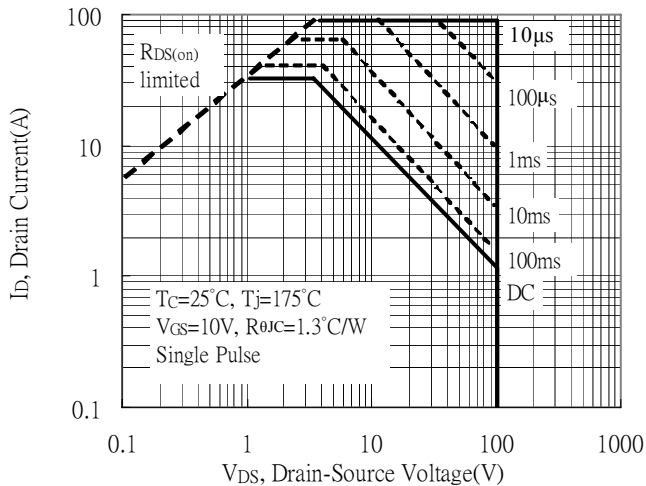

Maximum Drain Current vs Case Temperature

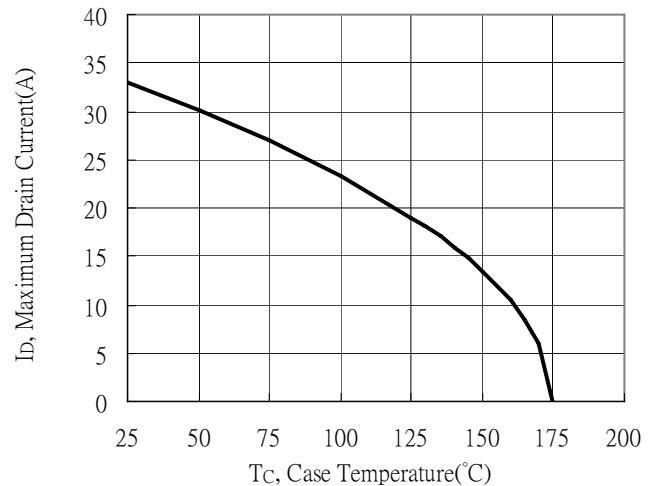



### Typical Characteristics(Cont.)

Typical Transfer Characteristics

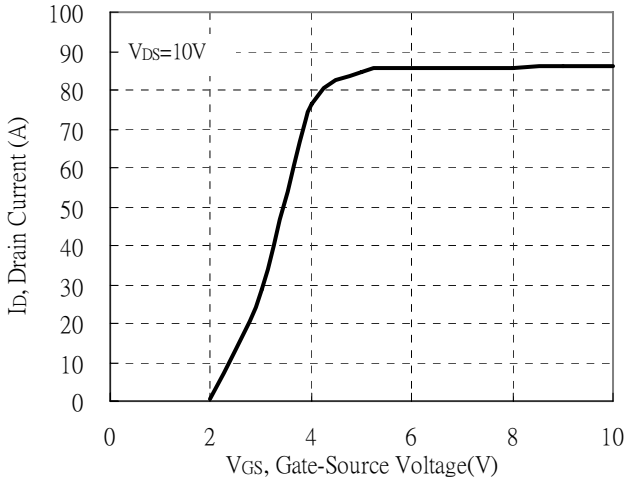

Power Derating Curve

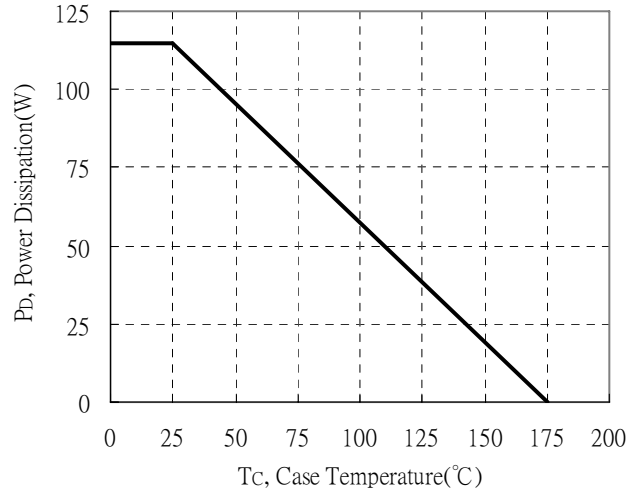

Transient Thermal Response Curves

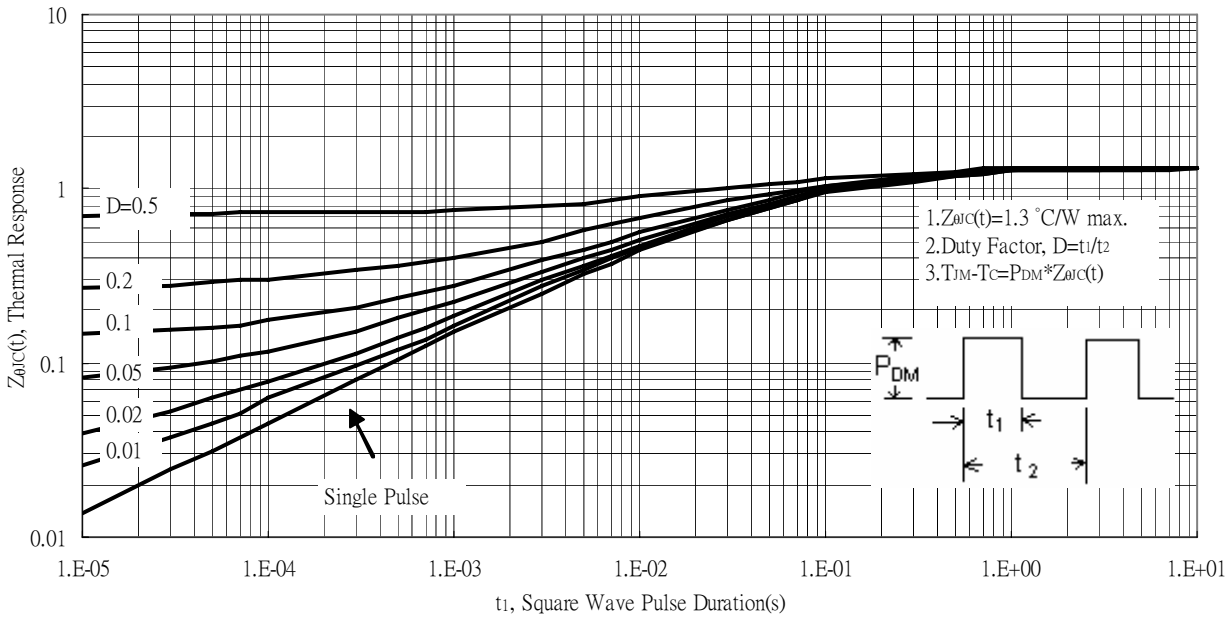



**Recommended wave soldering condition**

Product	Peak Temperature	Soldering Time
Pb-free devices	260 +0/-5 °C	5 +1/-1 seconds

**Recommended temperature profile for IR reflow**

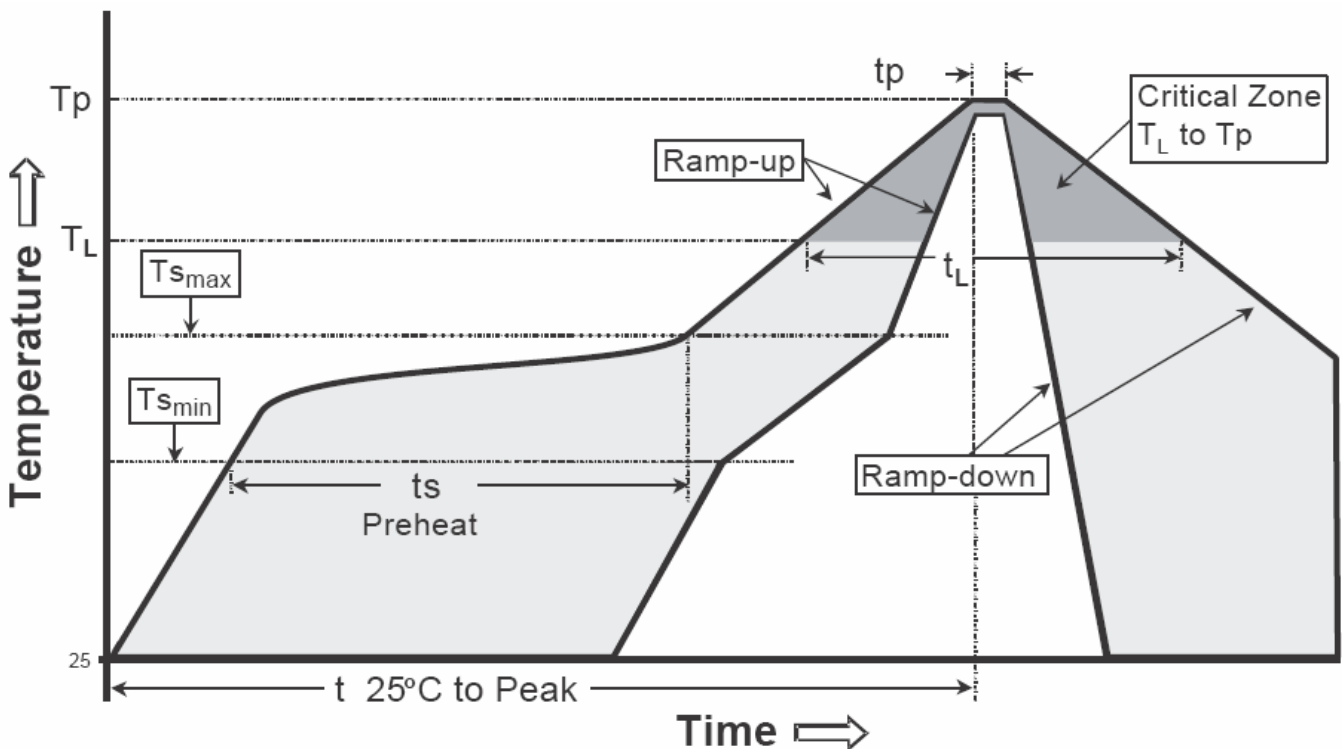

Profile feature	Sn-Pb eutectic Assembly	Pb-free Assembly
Average ramp-up rate (T <sub>smax</sub> to T <sub>p</sub> )	3°C/second max.	3°C/second max.
Preheat		
-Temperature Min(T <sub>s min</sub> )	100°C	150°C
-Temperature Max(T <sub>s max</sub> )	150°C	200°C
-Time(t <sub>s min</sub> to t <sub>s max</sub> )	60-120 seconds	60-180 seconds
Time maintained above:		
-Temperature (T <sub>L</sub> )	183°C	217°C
- Time (t <sub>L</sub> )	60-150 seconds	60-150 seconds
Peak Temperature(T <sub>P</sub> )	240 +0/-5 °C	260 +0/-5 °C
Time within 5°C of actual peak temperature(tp)	10-30 seconds	20-40 seconds
Ramp down rate	6°C/second max.	6°C/second max.
Time 25 °C to peak temperature	6 minutes max.	8 minutes max.

Note : All temperatures refer to topside of the package, measured on the package body surface.



**TO-252 Dimension**

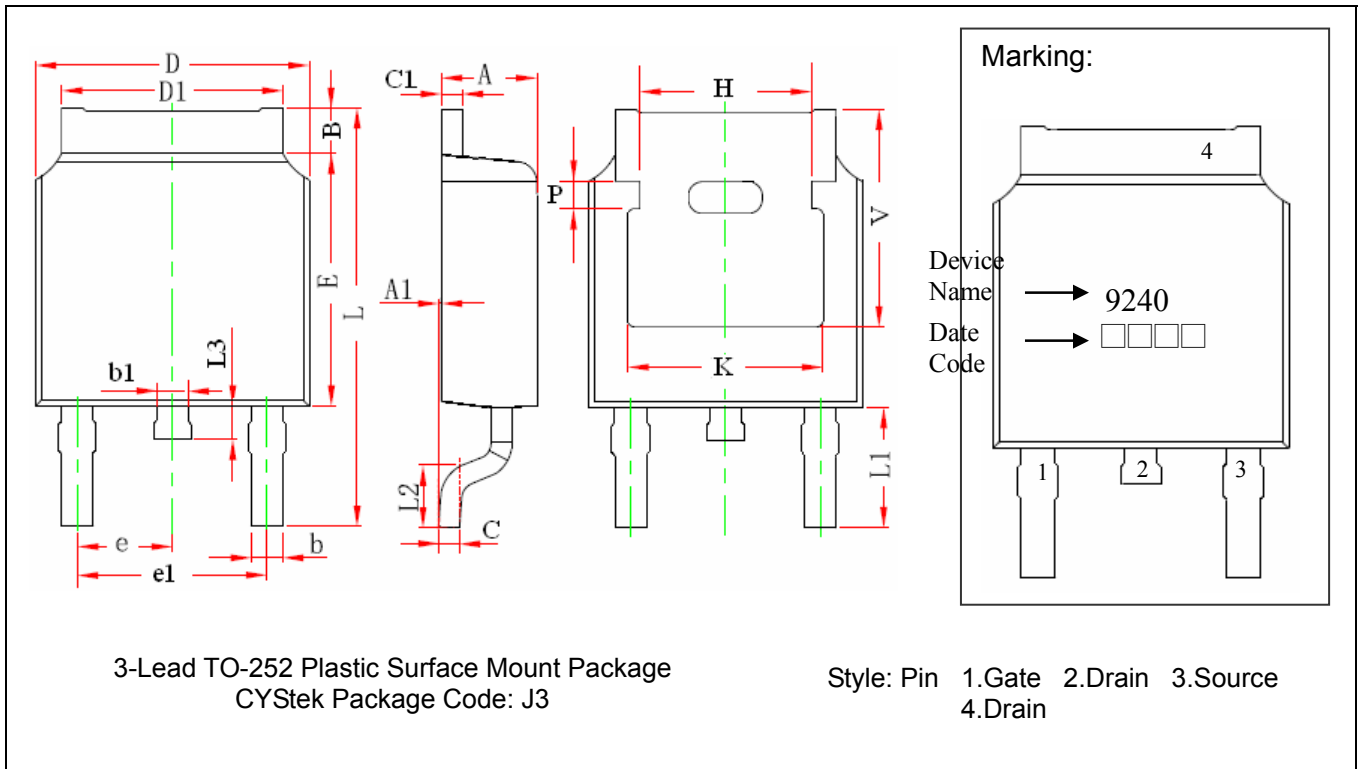

DIM	Inches		Millimeters		DIM	Inches		Millimeters	
	Min.	Max.	Min.	Max.		Min.	Max.	Min.	Max.
A	0.087	0.094	2.200	2.400	e	0.086	0.094	2.186	2.386
A1	0.000	0.005	0.000	0.127	e1	0.172	0.188	4.372	4.772
B	0.039	0.048	0.990	1.210	H	0.163	REF	4.140	REF
b	0.026	0.034	0.660	0.860	K	0.190	REF	4.830	REF
b1	0.026	0.034	0.660	0.860	L	0.386	0.409	9.800	10.400
C	0.018	0.023	0.460	0.580	L1	0.114	REF	2.900	REF
C1	0.018	0.023	0.460	0.580	L2	0.055	0.067	1.400	1.700
D	0.256	0.264	6.500	6.700	L3	0.024	0.039	0.600	1.000
D1	0.201	0.215	5.100	5.460	P	0.026	REF	0.650	REF
E	0.236	0.244	6.000	6.200	V	0.211	REF	5.350	REF

Notes: 1.Controlling dimension: millimeters.  
 2.Maximum lead thickness includes lead finish thickness, and minimum lead thickness is the minimum thickness of base material.  
 3.If there is any question with packing specification or packing method, please contact your local CYStek sales office.

**Material:**

- Lead : Pure tin plated.
- Mold Compound: Epoxy resin family, flammability solid burning class: UL94V-0.

**Important Notice:**

- All rights are reserved. Reproduction in whole or in part is prohibited without the prior written approval of CYStek.
- CYStek reserves the right to make changes to its products without notice.
- CYStek **semiconductor products are not warranted to be suitable for use in Life-Support Applications, or systems.**
- CYStek assumes no liability for any consequence of customer product design, infringement of patents, or application assistance.