

# PWM Control Circuit

# KK494

The KKK494 incorporates on a single monolithic chip all the functions required in the construction of a pulse-width-modulation control circuit. Designed primarily for power supply control, the KK494 contains an on-chip 5-volt regulator, two error amplifiers, adjustable oscillator, dead-time control comparator, pulse-steering flip-flop, and output-control circuitry. The uncommitted output transistors provide either common-emitter or emitter-follower output capability. Push-pull or single-ended output operation may be selected through the output-control function. The architecture of the KK494 prohibits the possibility of either output being pulsed twice during push-pull operation.

- Complete PWM Power Control Circuitry
- Uncommitted Outputs for 200 mA Sink or Source
- Output Control Selects Single-Ended or Push-Pull Operation
- Internal Circuitry Prohibits Double Pulse at Either Output
- Internal Regulator Provides a Stable 5 V Reference Supply
- Variable Dead-Time Provides Control Over Total Range

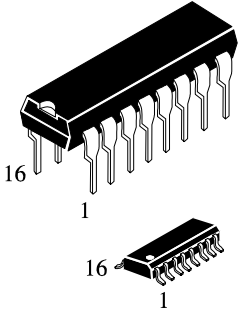

N SUFFIX PLASTIC  
D SUFFIX SOIC

**ORDERING INFORMATION**  
KK494N Plastic  
KK494D SOIC  
T<sub>A</sub> = -20°C to 85° C for all packages

## FUNCTION TABLE

Output Control	Output Function
Grounded	Single-ended or Parallel Output
At V <sub>ref</sub>	Normal Push-Pull Operation

## PIN ASSIGNMENT

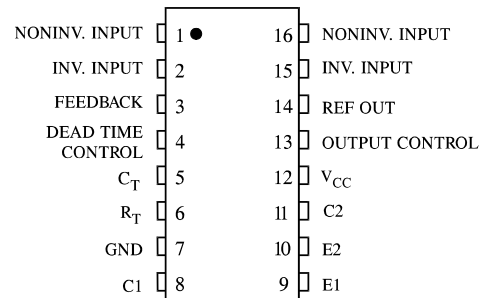

## LOGIC DIAGRAM

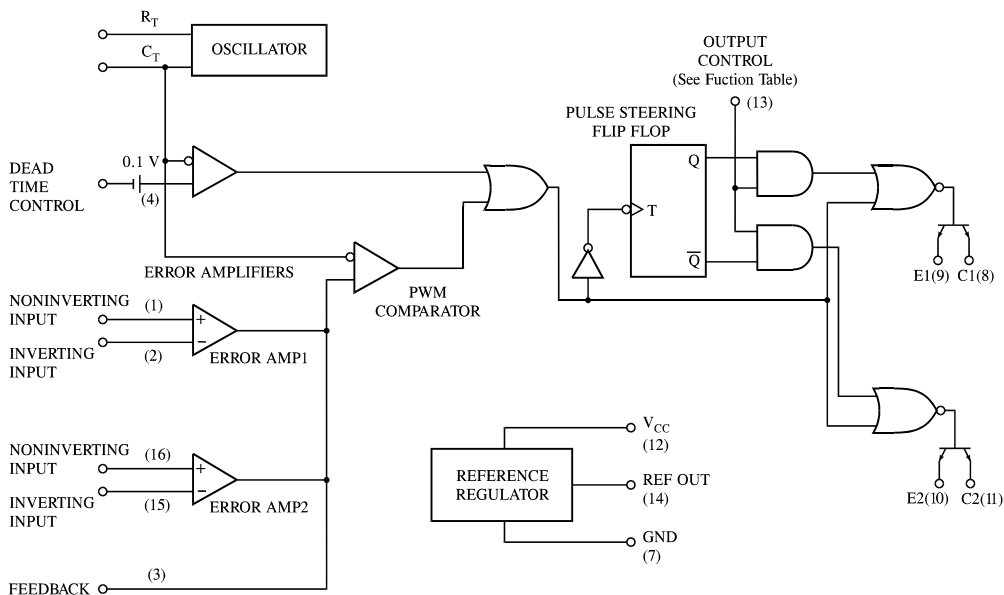

**MAXIMUM RATINGS**

Symbol	Parameter	Value	Unit
V <sub>CC</sub>	Supply Voltage	41	V
V <sub>I</sub>	Amplifier Input Voltage	V <sub>CC</sub> + 0.3	V
V <sub>O</sub>	Collector Output Voltage	41	V
	Collector Output Current	250	mA
T <sub>stg</sub>	Storage Temperature	-65 to +150	°C

**RECOMMENDED OPERATING CONDITIONS**

Symbol	Parameter	Min	Max	Unit
V <sub>CC</sub>	Supply Voltage	7	40	V
V <sub>I</sub>	Amplifier Input Voltage	-0.3	V <sub>CC</sub> - 2	V
V <sub>O</sub>	Collector Output Voltage		40	V
	Collector Output Current (Each Transistor)		200	mA
	Current Into Feed back Terminal		0.3	mA
C <sub>T</sub>	Timing Capacitor	0.47	10.000	nF
R <sub>T</sub>	Timing Resistor	1.8	500	KΩ
	Oscillator Frequency	1	300	KHz
T <sub>A</sub>	Operating Free-Air Temperature	-20	+85	°C

**ELECTRICAL CHARACTERISTICS** (Temperature -20 ~ 85°C,  $V_{CC} = 15\text{ V}$ ,  $f=10\text{ kHz}$ )

Symbol	Parameter	Test Conditions	Min	Max	Unit
<b>Reference Section</b>					
$V_{ref}$	Output Voltage	$I_O=1\text{ mA}$	4.75	5.25	V
$V_{regin}$	Output regulation	$V_{CC}=7\text{ V to }40\text{ V}$ , $T_A=25^\circ\text{C}$		25	mV
$V_{regout}$	Input regulation	$I_O=1\text{ to }10\text{ mA}$ , $T_A=25^\circ\text{C}$		15	mV
$\Delta V_{ref}$	Output Voltage change with temperature	$T_A = -20^\circ\text{C to }85^\circ\text{C}$		1	%
$I_{SC}$	Short-circuit output current (Note 1)	$V_{ref}=0$		50	mA
<b>Oscillator Section</b>					
$f_{OSC}$	Frequency	$C_T=0.01\text{ }\mu\text{F}$ , $R_T=12\text{ k}\Omega$	6	14	KHz
$\delta f_{OSC}$	Standard deviation of frequency (Note 2)	All values of $V_{CC}$ , $C_T$ , $R_T$ , $T_A$ Constant		15	%
$\delta f_{OSC(\Delta V)}$	Frequency change with voltage	$V_{CC}=7\text{ V to }40\text{ V}$ , $T_A=25^\circ\text{C}$		10	%
$\delta f_{OSC(\Delta T)}$	Frequency change with temperature	$C_T=0.01\text{ }\mu\text{F}$ , $R_T=12\text{ k}\Omega$ $T_A = -20^\circ\text{C to }85^\circ\text{C}$		2	%
<b>Dead Time Control Section</b>					
$I_{IB(2T)}$	Input bias current (pin 4)	$V_I = 0\text{ to }5.25\text{ V}$		-10	$\mu\text{A}$
$DC_{max}$	Maximum duty cycle, each output	$V_{I(\text{pin }4)}=0\text{ V}$	45		%
$V_{THD}$	Input threshold voltage (pin 4)	Zero duty cycle		3.3	V
		Maximum duty cycle	0		
<b>Error Amp Section</b>					
$V_{IO}$	Input offset voltage	$V_{O(\text{pin }3)}=2.5\text{ V}$		10	mV
$I_{IO}$	Input offset current	$V_{O(\text{pin }3)}=2.5\text{ V}$		250	nA
$I_{IB}$	Input bias current	$V_{O(\text{pin }3)}=2.5\text{ V}$		1	$\mu\text{A}$
	Common-mode input voltage range	$V_{CC}=7\text{ V to }40\text{ V}$	LOW	-0.3	V
			HIGH	$V_{CC} - 2$	
$A_{vol}$	Open-loop voltage amplification	$\Delta V_O=3\text{ V}$ , $V_O=0.5\text{ to }3.5\text{ V}$	70		dB
$f_b$	Unity-gain bandwidth		100		kHz
CMRR	Common-mode rejection ratio	$V_{CC}=40\text{ V}$ , $T_A=25^\circ\text{C}$	65		dB
$I_O$	Output sink current (pin 3)	$V_{ID}=-15\text{ mV to }-5\text{ V}$ , $V_{O(\text{pin }3)}=0.7\text{ V}$	0.3		mA
$I_{O+}$	Output source current (pin 3)	$V_{ID}=15\text{ mV to }5\text{ V}$ , $V_{O(\text{pin }3)}=3.5\text{ V}$	-2		mA

**ELECTRICAL CHARACTERISTICS** (Temperature -20 ~ 85°C, V<sub>CC</sub> = 15 V, f=10 kHz)

Symbol	Parameter		Test Conditions	Min	Max	Unit	
<b>PWM Comparator Section</b>							
V <sub>THP</sub>	Input threshold voltage (pin 3)		Zero duty cycle		4.5	V	
I <sub>I</sub>	Input sink current (pin 3)		V <sub>O(pin 3)</sub> =0.7 V	0.3		mA	
<b>Switching Characteristics</b>							
t <sub>rc</sub>	Output voltage rise time		Common-emitter configuration		200	ns	
t <sub>fc</sub>	Output voltage fall time		Common-emitter configuration		100	ns	
t <sub>rf</sub>	Output voltage rise time		Emitter-follower configuration		200	ns	
t <sub>ff</sub>	Output voltage fall time		Emitter-follower configuration		100	ns	
<b>Output Section</b>							
I <sub>C(off)</sub>	Collector off-state current		V <sub>CE</sub> =40 V, V <sub>CC</sub> =40 V		100	μA	
I <sub>E(off)</sub>	Emitter off-state current		V <sub>CC</sub> =V <sub>C</sub> =40 V, V <sub>E</sub> =0		-100	μA	
V <sub>SAT</sub>	Collector-emitter	Common-emitter	V <sub>E</sub> =0, I <sub>C</sub> =200 mA		1.3	V	
	saturation voltage	Emitter-follower	V <sub>C</sub> =15 V, I <sub>E</sub> =-200 mA		2.5		
I <sub>OCH</sub>	Output control input current		V <sub>I</sub> =V <sub>ref</sub>		3.5	mA	
<b>Total Device</b>							
I <sub>CC</sub>	Standby supply current		All other inputs & outputs open	V <sub>CC</sub> =15 V		10	mA
				V <sub>CC</sub> =40 V		15	
I <sub>CCA</sub>	Average supply current		V <sub>(pin 4)</sub> =2 V		17	mA	

**Notes:** 1. Duration of the short circuit should not exceed one second.

2. Standard deviation is a measure of the statistical distribution about the mean as derived from the formula

$$\sigma = \sqrt{\frac{\sum_{n=1}^N (x_n - \bar{x})^2}{N - 1}}$$

### N SUFFIX PLASTIC DIP (MS - 001BB)

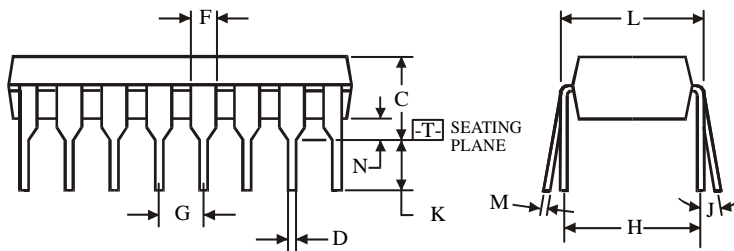
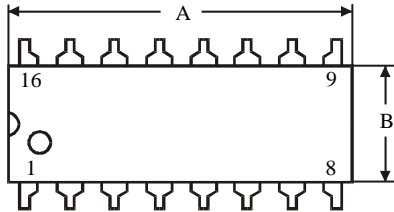
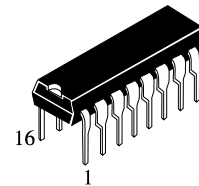

$\oplus 0.25 (0.010) \text{M} \text{T}$

**NOTES:**

- Dimensions "A", "B" do not include mold flash or protrusions.  
Maximum mold flash or protrusions 0.25 mm (0.010) per side.

Dimension, mm		
Symbol	MIN	MAX
A	18.67	19.69
B	6.1	7.11
C		5.33
D	0.36	0.56
F	1.14	1.78
G	2.54	
H	7.62	
J	0°	10°
K	2.92	3.81
L	7.62	8.26
M	0.2	0.36
N	0.38	

### D SUFFIX SOIC (MS - 012AC)

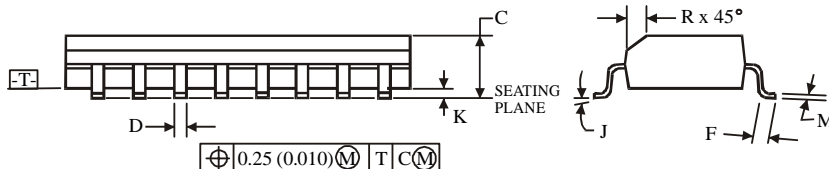
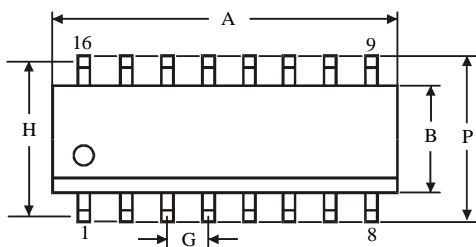
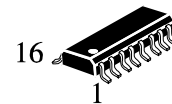

$\oplus 0.25 (0.010) \text{M} \text{T} \text{C} \text{M}$

**NOTES:**

- Dimensions A and B do not include mold flash or protrusion.
- Maximum mold flash or protrusion 0.15 mm (0.006) per side for A; for B - 0.25 mm (0.010) per side.

Dimension, mm		
Symbol	MIN	MAX
A	9.8	10
B	3.8	4
C	1.35	1.75
D	0.33	0.51
F	0.4	1.27
G	1.27	
H	5.72	
J	0°	8°
K	0.1	0.25
M	0.19	0.25
P	5.8	6.2
R	0.25	0.5