

GJ5103

NPN HIGH SPEED SWITCHING TRANSISTOR

Description

The GJ5103 is designed for high speed switching applications.

Features

- Low saturation voltage, typically $V_{CE(sat)} = 0.15V$ at $I_C/I_B = 3A/0.15A$
- High speed switching, typically $t_f = 0.1\mu s$ at $I_C = 3A$
- Wide SOA
- Complements to GJ1952

Package Dimensions

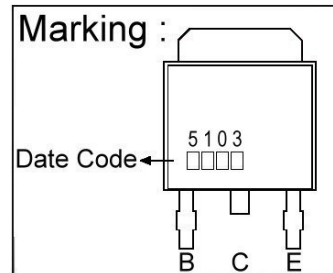
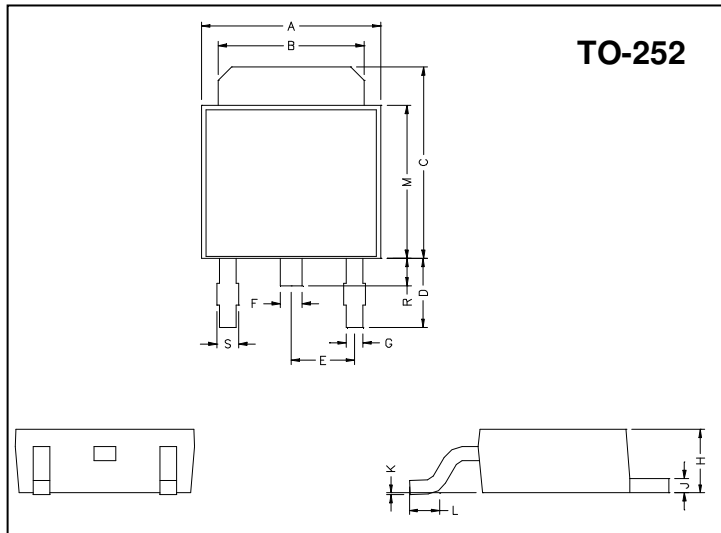

REF.	Millimeter		REF.	Millimeter	
	Min.	Max.		Min.	Max.
A	6.40	6.80	G	0.50	0.70
B	5.20	5.50	H	2.20	2.40
C	6.80	7.20	J	0.45	0.55
D	2.40	3.00	K	0	0.15
E	2.30 REF.		L	0.90	1.50
F	0.70	0.90	M	5.40	5.80
S	0.60	0.90	R	0.80	1.20

Absolute Maximum Ratings ($T_A = 25^\circ C$)

Parameter	Symbol	Ratings	Unit
Collector to Base Voltage	V_{CBO}	100	V
Collector to Emitter Voltage	V_{CEO}	60	V
Emitter to Base Voltage	V_{EBO}	5	V
Collector Current (DC)	I_C	5	A
Collector Current (Pulse $PW=100ms$)	I_C	10	A
Total Device Dissipation ($T_A = 25^\circ C$)	P_D	1	W
Total Device Dissipation ($T_C = 25^\circ C$)	P_D	10	W
Junction Temperature	T_J	150	$^\circ C$
Storage Temperature	T_{stg}	-55 ~ +150	$^\circ C$

Electrical Characteristics ($T_A = 25^\circ C$ unless otherwise noted)

Symbol	Min.	Typ.	Max.	Unit	Test Conditions
BV_{CBO}	100	-	-	V	$I_C = 50\mu A, I_E = 0$
BV_{CEO}	60	-	-	V	$I_C = 1mA, I_B = 0$
BV_{EBO}	5	-	-	V	$I_E = 50\mu A, I_C = 0$
I_{CBO}	-	-	10	μA	$V_{CB} = 100V, I_E = 0$
I_{EBO}	-	-	10	μA	$V_{EB} = 5V, I_C = 0$
* $V_{CE(sat)1}$	-	0.15	0.3	V	$I_C = 3A, I_B = 0.15A$
* $V_{CE(sat)2}$	-	-	0.5	V	$I_C = 4A, I_B = 0.2A$
* $V_{BE(sat)1}$	-	-	1.2	V	$I_C = 3A, I_B = 0.15A$
* $V_{BE(sat)2}$	-	-	1.5	V	$I_C = 4A, I_B = 0.2A$
* h_{FE1}	120	-	270		$V_{CE} = 2V, I_C = 1A$
* h_{FE2}	40	-	-		$V_{CE} = 2V, I_C = 3A$
f_T	-	210	-	MHz	$V_{CB} = 10V, I_E = -0.5A, f = 30MHz$
C_{ob}	-	80	-	pF	$V_{CE} = 10V, I_E = 0, f = 1MHz$

ton (Turn-on Time)	-	-	0.3	uS	$I_C=3A, R_L=10\Omega$ $I_{B1}=-I_{B2}=0.15A$ $V_{CC}\approx 30V$
tstg (Storage Time)	-	-	1.5		
tf (Fall Time)	-	0.1	0.3		

*Measure using pulse current

Switching Time Test Circuit

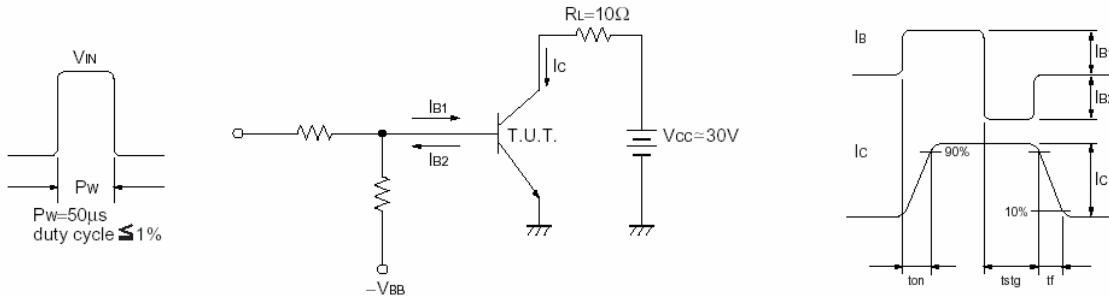

Characteristics Curve

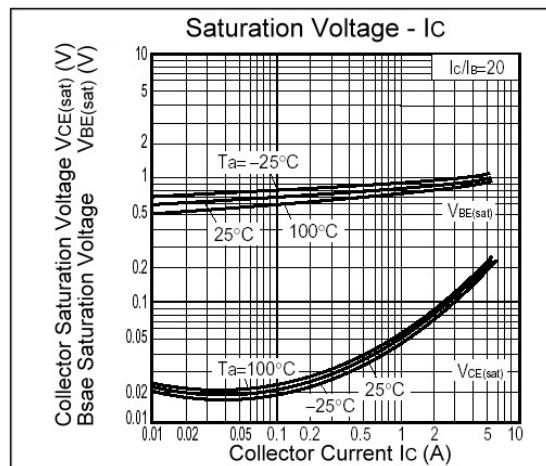
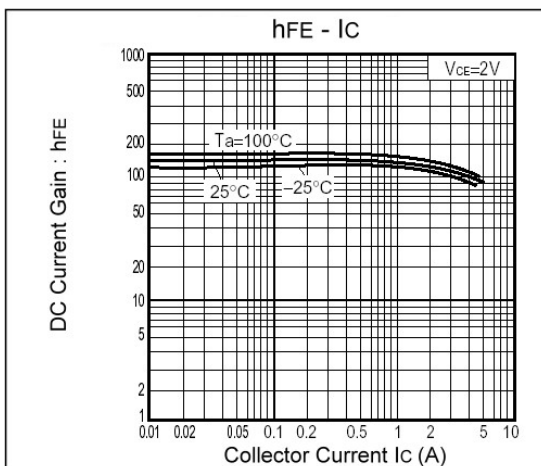
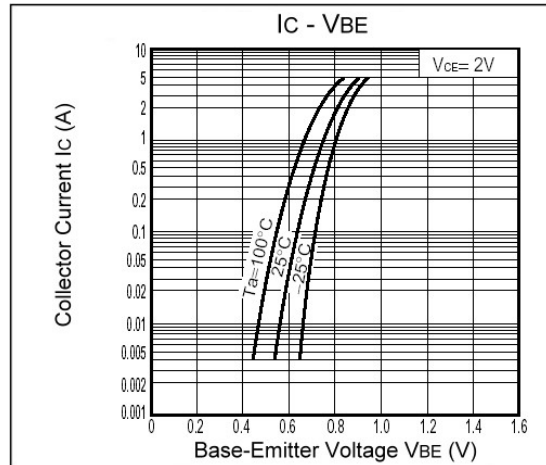
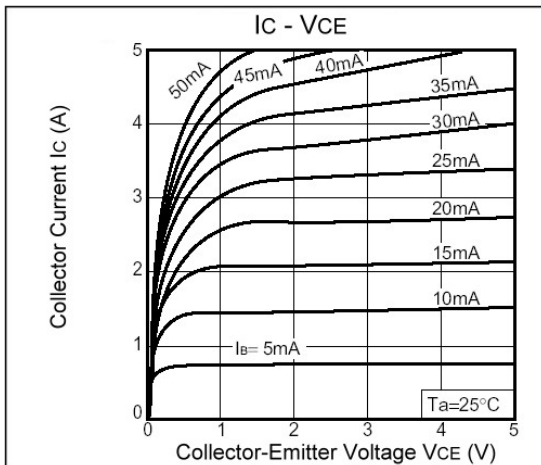

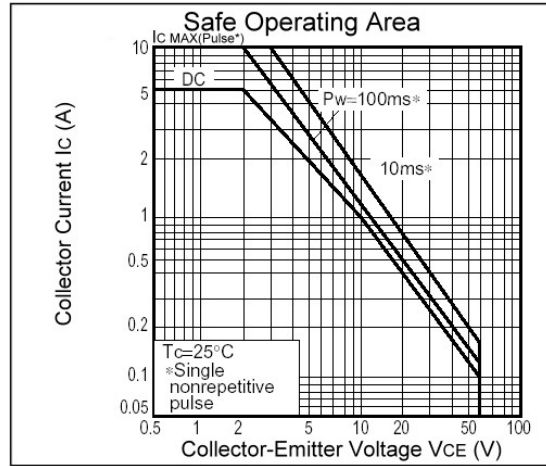
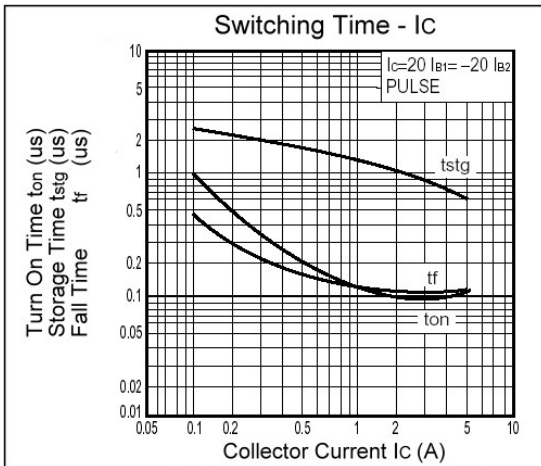
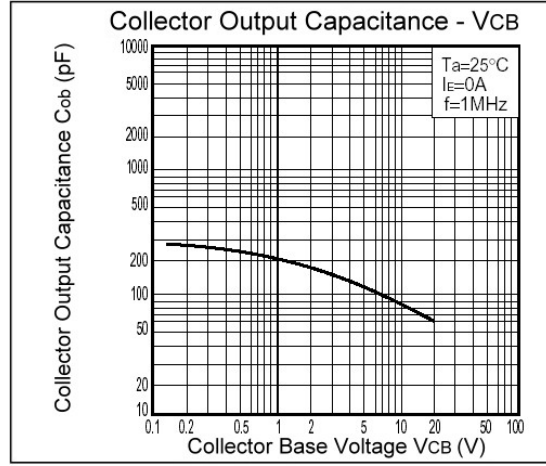
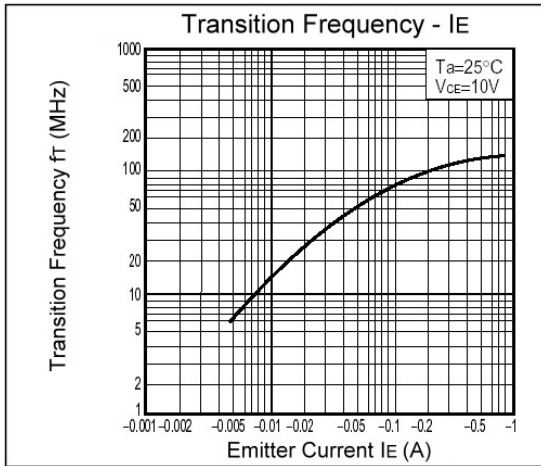

Important Notice:

- All rights are reserved. Reproduction in whole or in part is prohibited without the prior written approval of GTM.
- GTM reserves the right to make changes to its products without notice.
- GTM semiconductor products are not warranted to be suitable for use in life-support Applications, or systems.
- GTM assumes no liability for any consequence of customer product design, infringement of patents, or application assistance.

Head Office And Factory:

- **Taiwan:** No. 17-1 Tatung Rd. Fu Kou Hsin-Chu Industrial Park, Hsin-Chu, Taiwan, R. O. C.
- TEL : 886-3-597-7061 FAX : 886-3-597-9220, 597-0785
- **China:** (201203) No.255, Jang-Jiang Tsai-Lueng RD. , Pu-Dung-Hsin District, Shang-Hai City, China
- TEL : 86-21-5895-7671 ~ 4 FAX : 86-21-38950165